

СОДЕРЖАНИЕ

- | | |
|------------|--|
| 01. | Содержание, оглавление, термины |
| 02. | Профили |
| 03. | Уплотнители, пластиковые адаптеры и вставки,
термомосты |
| 04. | Комплекующие и аксессуары |
| 05. | Сечения |
| 06. | Узлы |
| 07. | Остекление |
| 08. | Фурнитура |
| 09. | Сборка |
| 10. | Монтаж |

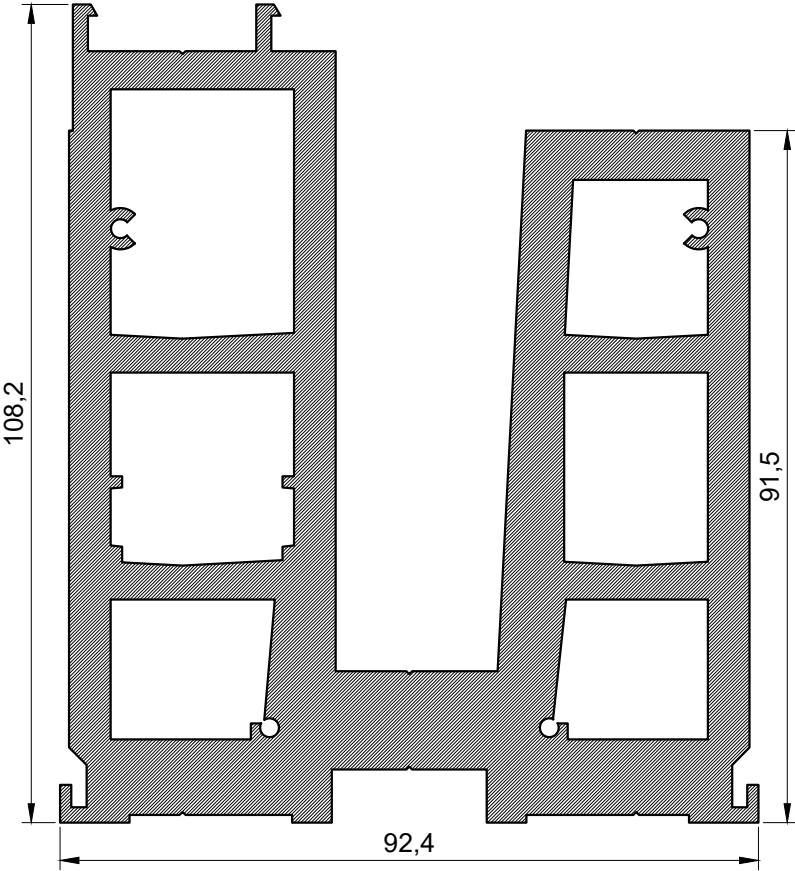

Сечение	Артикул Наименование	I_x см ⁴ I_y см ⁴	W_x см ³ W_y см ³	S см ² P мм
	<p>11-0402 Опора 17,52</p>			<p>37,7747 581</p>

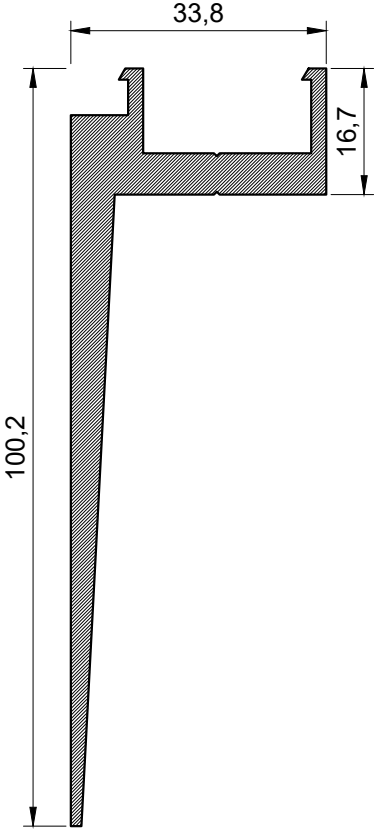
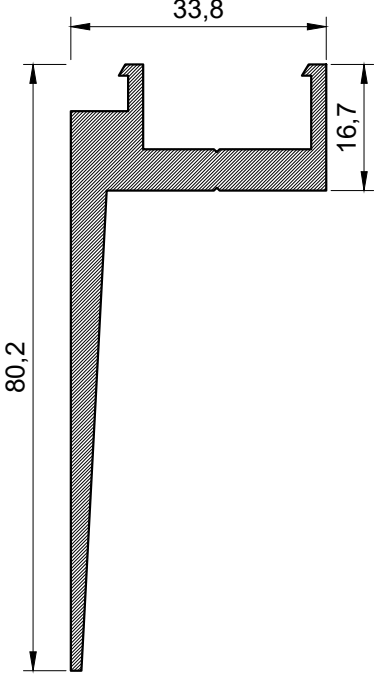

Сечение	Артикул Наименование	I_x см ⁴ I_y см ⁴	W_x см ³ W_y см ³	S см ² P мм
	<p>11-6501 Прижим 21,52</p>			<p>5,801 284</p>
	<p>11-6502 Прижим 17,52</p>			<p>4,7497 245</p>

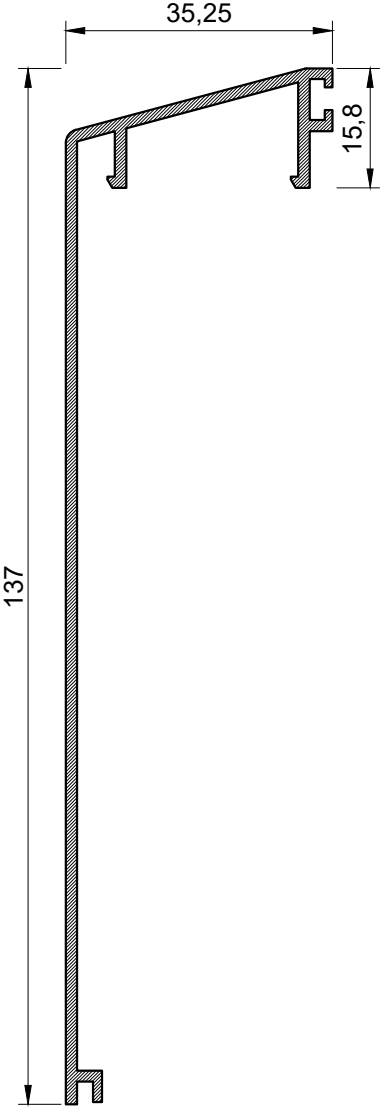

Сечение	Артикул Наименование	I_x см ⁴ I_y см ⁴	W_x см ³ W_y см ³	S см ² P мм
	<p>11-6601 Капот 21,52</p>			<p>$\frac{2,8897}{387}$</p>



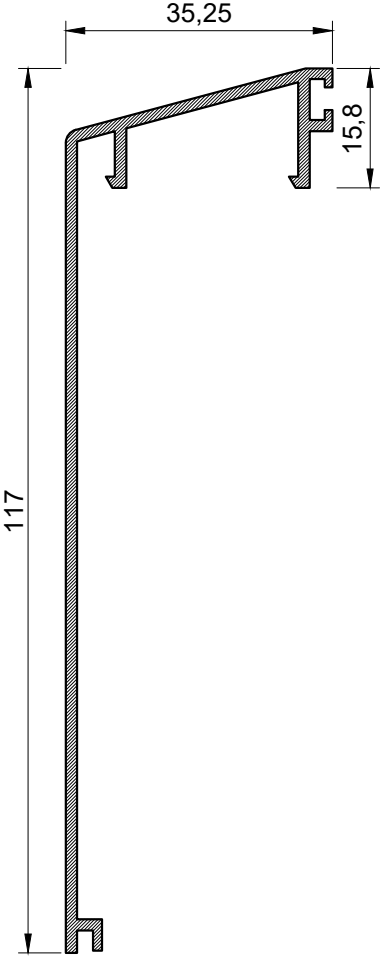
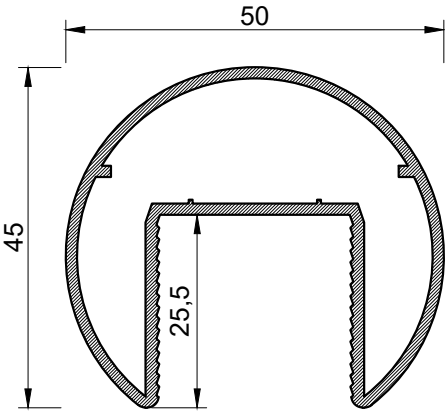



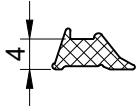
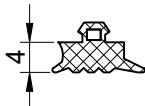
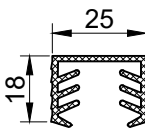
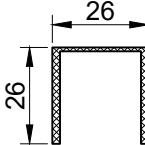



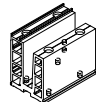

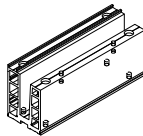

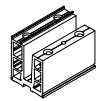

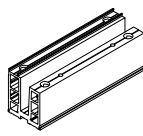



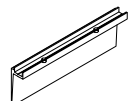

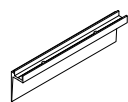

Сечение	Артикул Наименование	$\frac{I_x}{I_y}$ см ⁴	$\frac{W_x}{W_y}$ см ³	$\frac{S}{P}$ см ² мм
	<p>11-6602 Капот 17,52</p>			<p>2,638302 352</p>
	<p>11-6801 Поручень 22 мм Д50</p>			<p>2,932769 200</p>

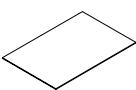

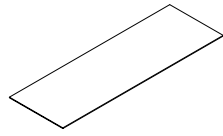



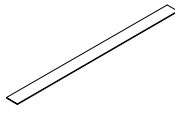



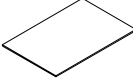

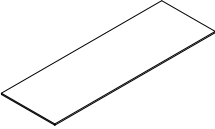

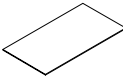

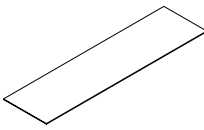

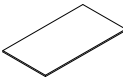
Сечение	Ед. Изм.	Н.У.	Артикул Наименование
	пог. м	250	50-1140 Уплотнитель под штапик 4 мм
	пог. м	200	50-2040 Уплотнитель под СП 4 мм
	пог. м	999	51-0050 Уплотнитель соединительный 17/24 мм
	пог. м	999	51-0060 Уплотнитель соединительный 21/24 мм

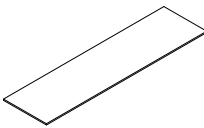
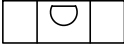

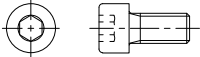
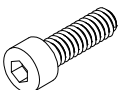
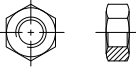
Сечение	Внешний вид	Ед. Изм.	Н.У.	Артикул Наименование
		шт.	1	21-0401/1500 Опора стекла x150 мм
		шт.	1	21-0401/3000 Опора стекла x300 мм
		шт.	1	21-0402/1500 Опора стекла x150 мм
		шт.	1	21-0402/3000 Опора стекла x300 мм
		шт.	1	21-6501/1500 Прижим x150 мм
		шт.	1	21-6501/3000 Прижим x300 мм
		шт.	1	21-6502/1500 Прижим x150 мм
		шт.	1	21-6502/3000 Прижим x300 мм
		шт.	1	32-0006 Паронит 1x100x150 мм
		шт.	1	32-0007 Паронит 1x100x300 мм
		шт.	1	32-0008 Паронит 1x20x150 мм
		шт.	1	32-0009 Паронит 1x20x300 мм

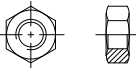

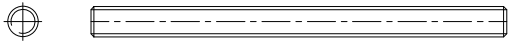
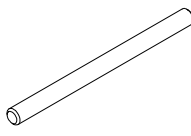
Сечение	Внешний вид	Ед. Изм.	Н.У.	Артикул Наименование
		шт.	1	32-0010 Паронит 2x100x150 мм
		шт.	1	32-0011 Паронит 2x100x300 мм
		шт.	1	32-0014 Паронит 1x80x150 мм
		шт.	1	32-0015 Паронит 1x80x300 мм
		шт.	1	32-0016 Паронит 2x80x150 мм
		шт.	1	32-0017 Паронит 2x80x300 мм
		шт.	1	32-0005 Уровень пузырьковый 8x23 мм
		шт.	1	46-DIN125 A2 M8 Шайба
		шт.	1	46-DIN912 A2 M8x16 HEX6 Винт с цилиндрической головкой
		шт.	1	46-DIN934 Zn 8.8 M8 Гайка
		шт.	1	46-DIN934 A4 M8 Гайка
		шт.	1	46-DIN976B Zn 8.8 M8x110 Шпилька M8x110 мм



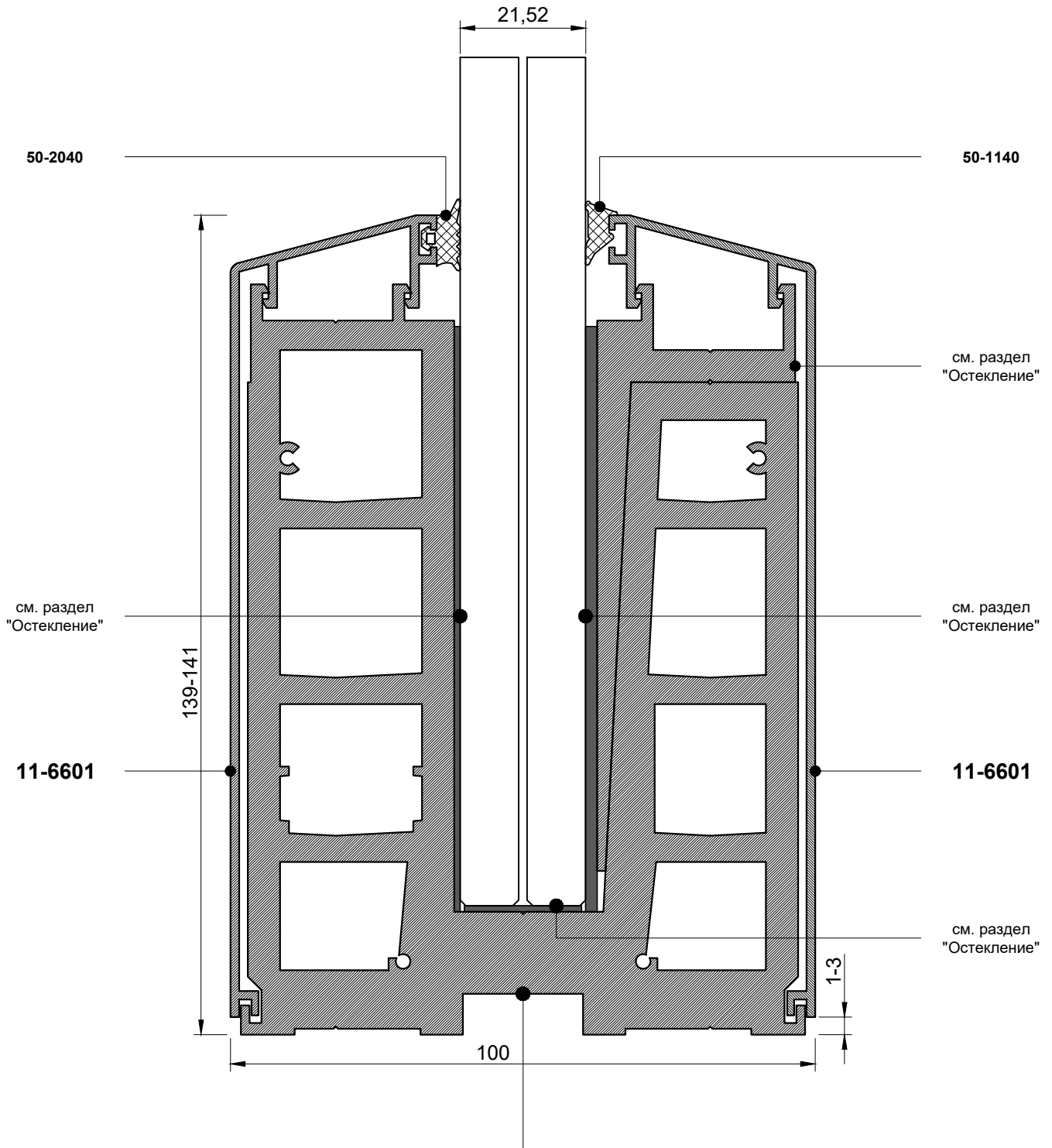

21-0401/1500

21-0401/3000

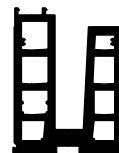
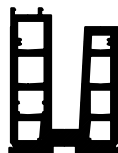

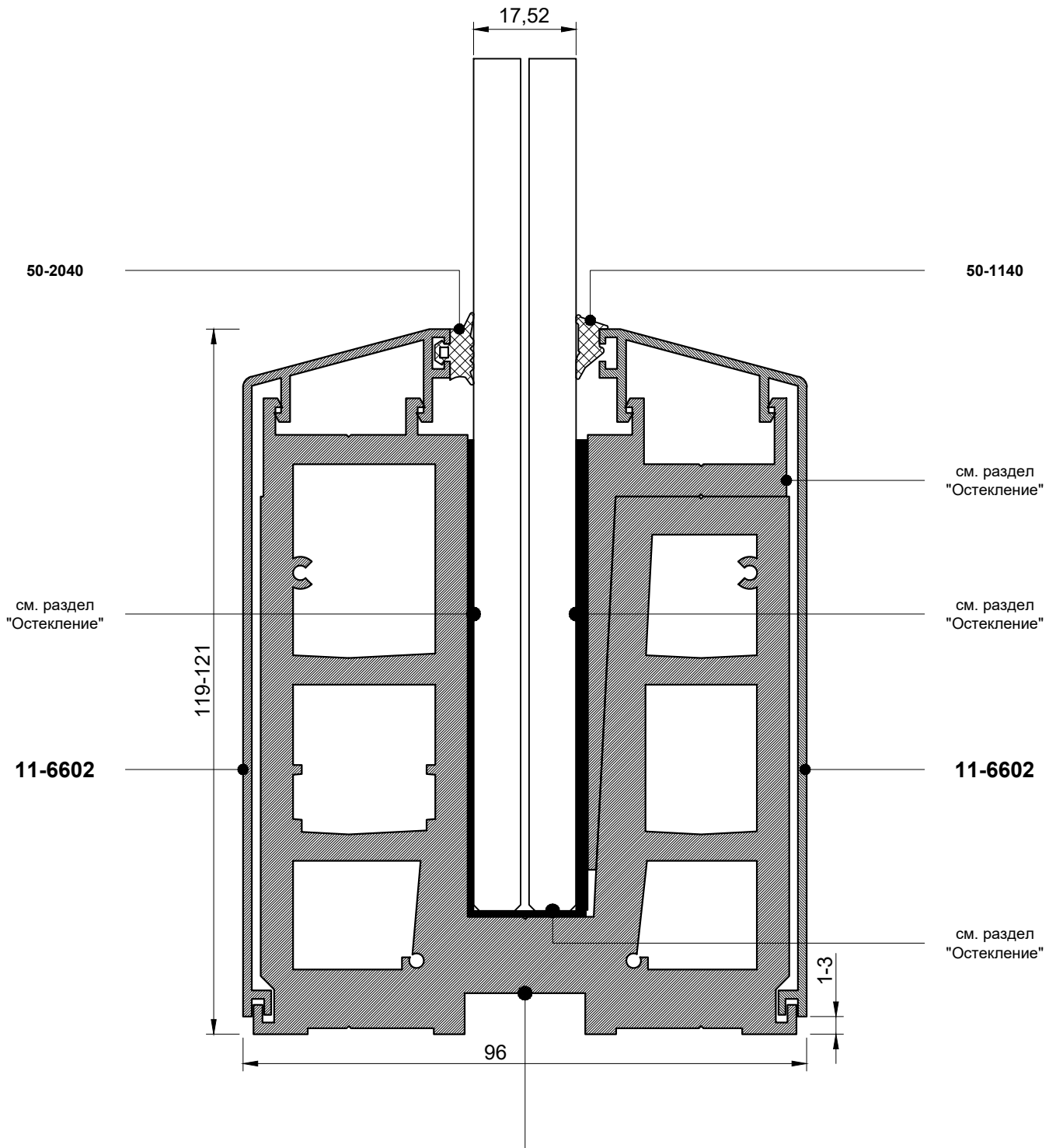

21-0402/1500

21-0402/3000

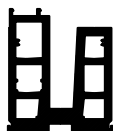

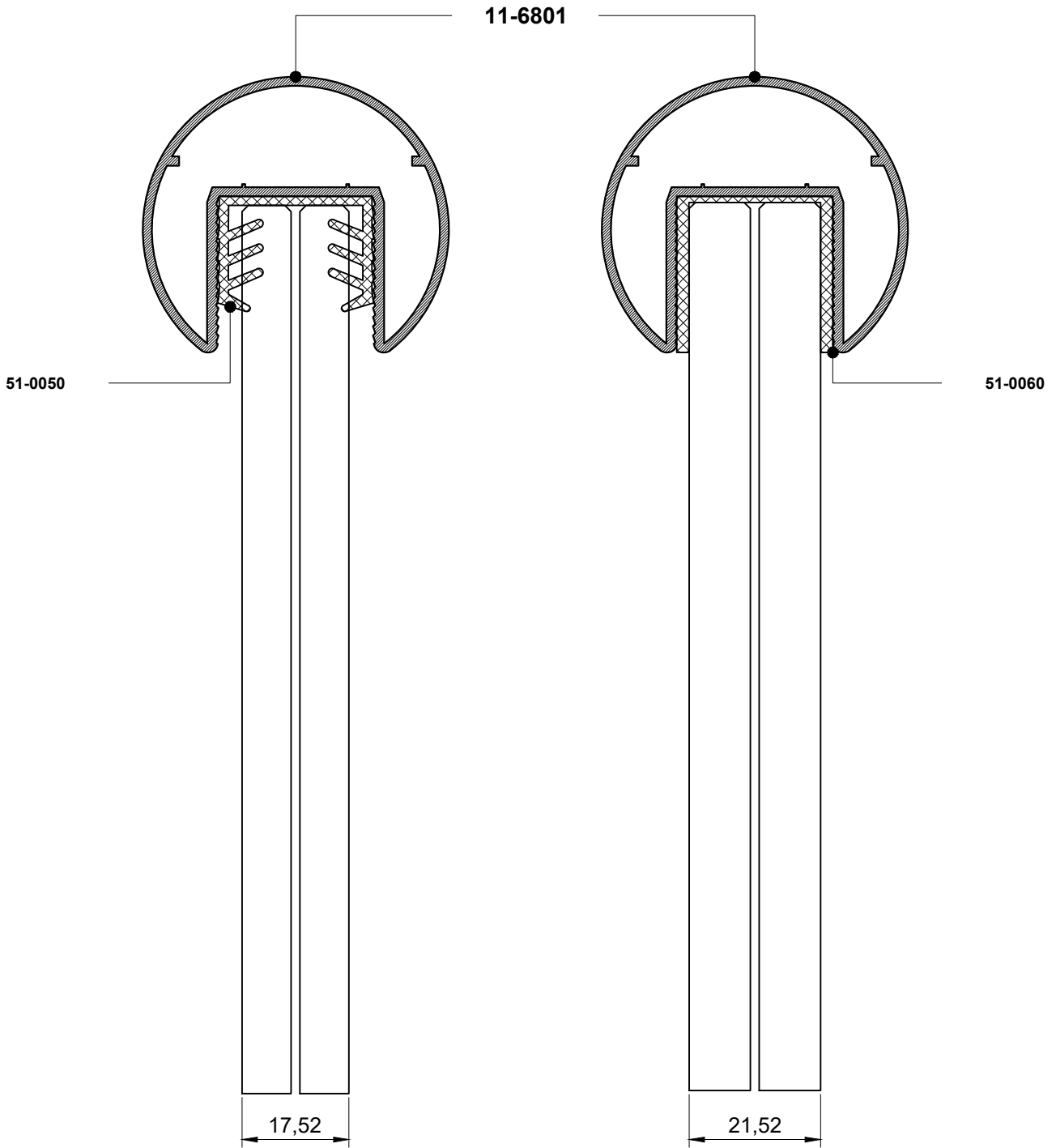

Триплекс 8+8 мм

Триплекс 10+10 мм

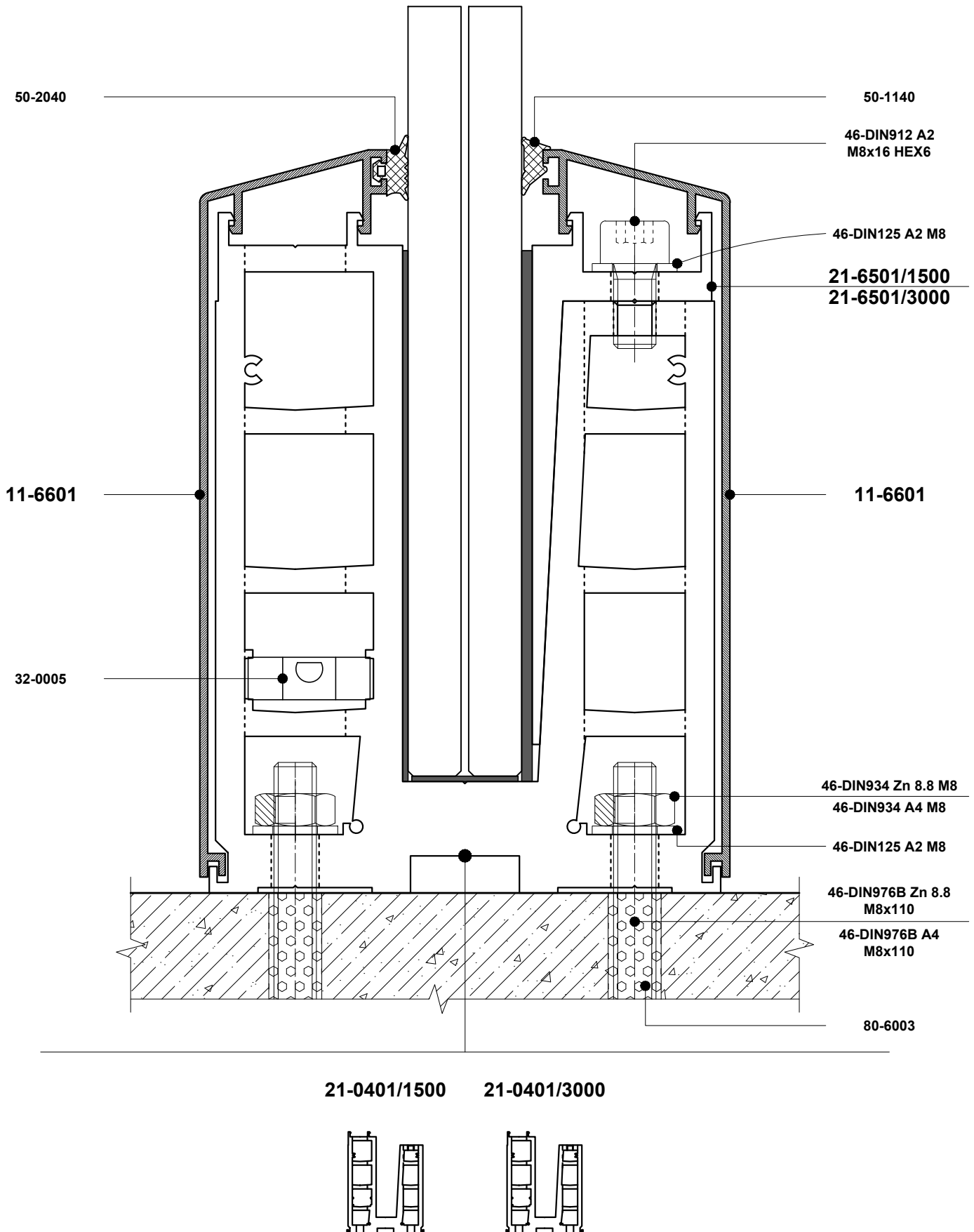

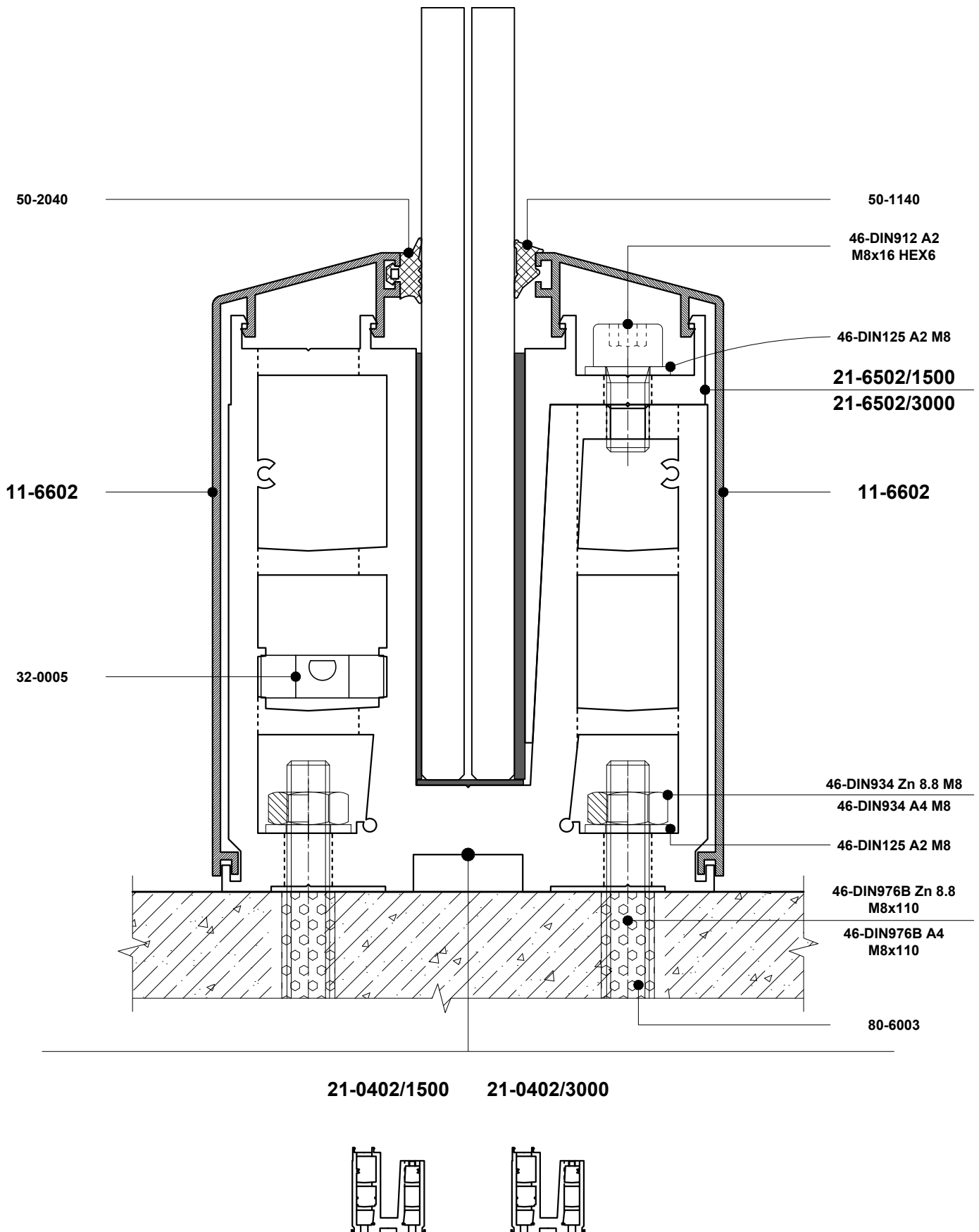

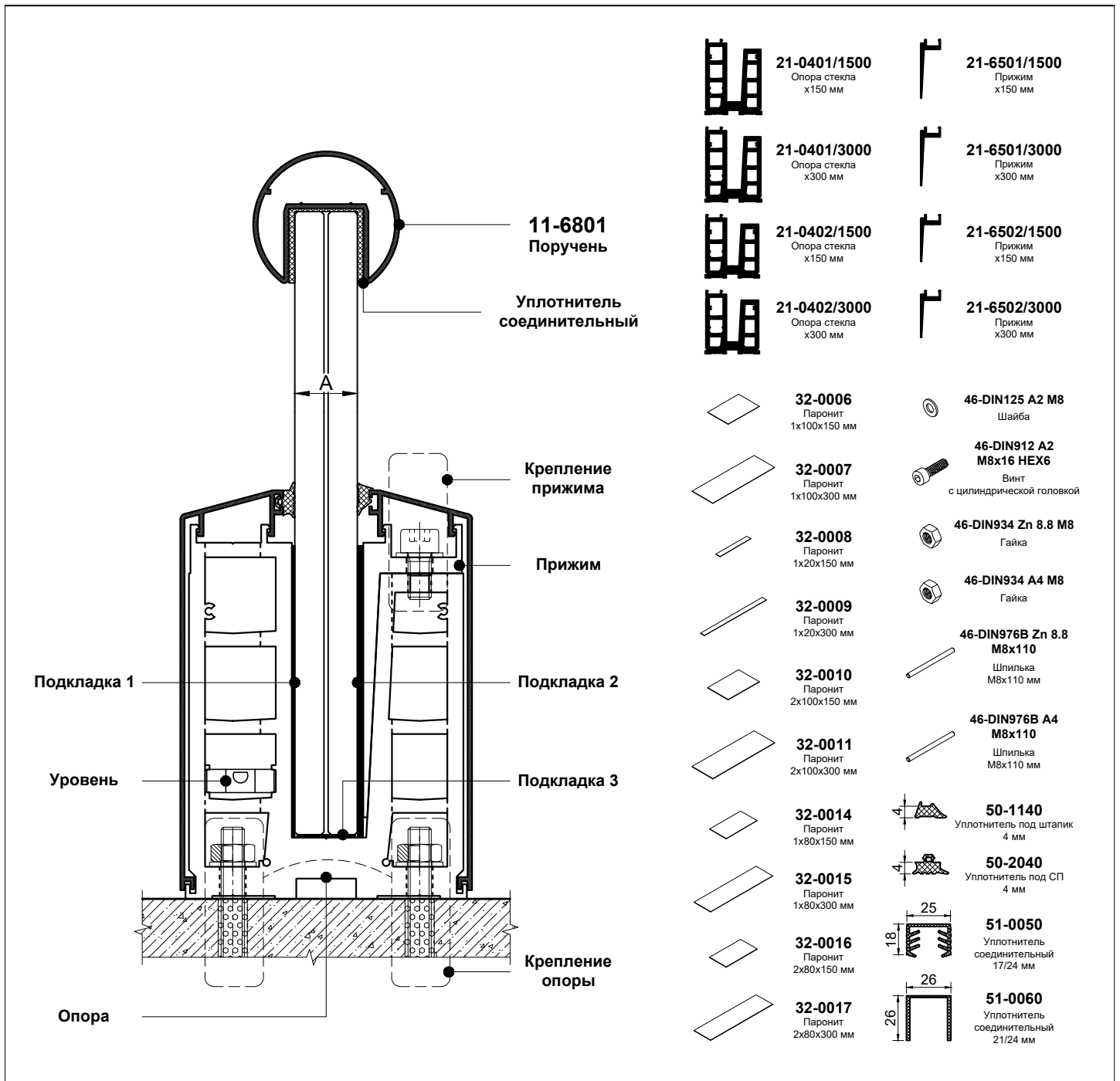

Толщина заполнения, А мм	Опора	Подкладка 1 Подкладка 2 Подкладка 3	Прижим	Крепление прижима	Крепление опоры	
					Снаружи помещения	Внутри помещения
17,52	21-0402/1500	32-0006 32-0010 32-0008	21-6501/1500	46-DIN125 A2 M8 46-DIN912 A2 M8x16 HEX6		
	21-0402/3000	32-0007 32-0011 32-0009	21-6501/3000	46-DIN125 A2 M8 x2 46-DIN912 A2 M8x16 HEX6 x2	46-DIN976B A4 M8x110 x4 46-DIN934 A4 M8 x4	46-DIN976B Zn 8.8 M8x110 x4 46-DIN934 Zn 8.8 M8 x4
21,52	21-0401/1500	32-0014 32-0016 32-0008	21-6502/1500	46-DIN125 A2 M8 46-DIN912 A2 M8x16 HEX6	46-DIN125 A2 M8 x4 80-6003 x4	46-DIN125 A2 M8 x4 80-6003 x4
	21-0401/3000	32-0015 32-0017 32-0009	21-6502/3000	46-DIN125 A2 M8 x2 46-DIN912 A2 M8x16 HEX6 x2		

