

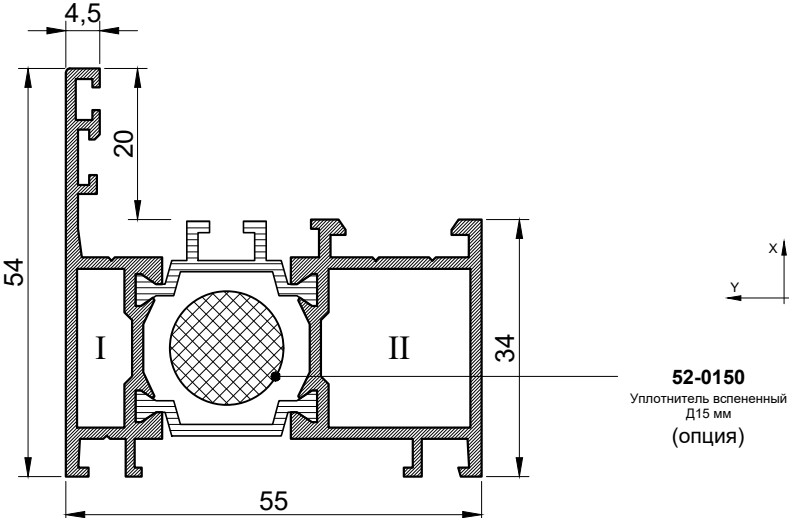

СОДЕРЖАНИЕ

- 01.** Содержание, оглавление, термины
- 02.** Профили
- 03.** Уплотнители, пластиковые адаптеры и вставки,
термомосты
- 04.** Комплектующие и аксессуары
- 05.** Сечения
- 06.** Узлы
- 07.** Остекление
- 08.** Фурнитура
- 09.** Сборка

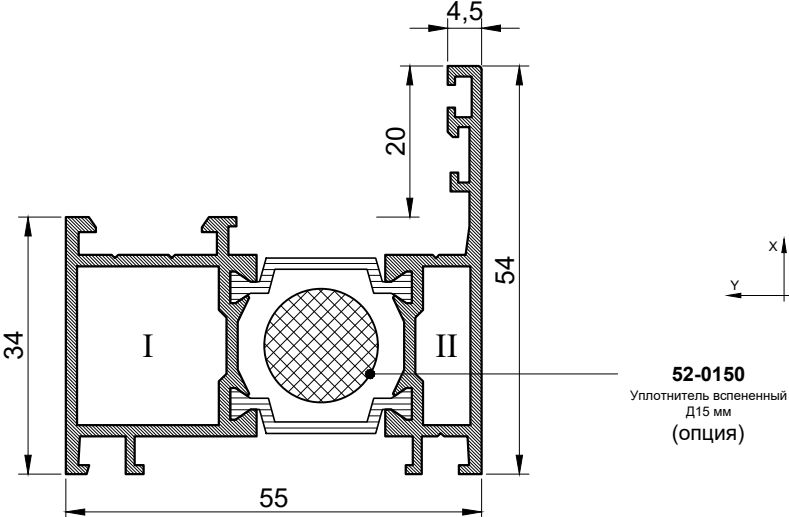

Сечение	Артикул Наименование	I_x см ⁴	W_x см ³	S см ²
		I_y см ⁴	W_y см ³	P мм
 <p>52-0150 Уплотнитель вспененный Д15 мм (опция)</p>	<p>15-2110 Рама 54 мм</p>	15,69	5,10	3,800
		6,51	1,93	357
 <p>52-0150 Уплотнитель вспененный Д15 мм (опция)</p>	<p>15-2111 Рама 54 мм для створки-Т</p>	15,69	5,10	3,800
		6,51	1,93	357

Профиль	Сухари		Химия	Комплектующие			
	Чаша I	Чаша II		Сбивка угла на прессе		Сборка угла на штифтах	
				Чаша I	Чаша II	Чаша I	Чаша II
Соединение L							
15-2110	20-0200/0059	20-0200/0184	80-2002 6 мл 80-3002 2 мл 80-4001 2 мл 80-9001 1 мл	31-0011		40-DIN1481 A2 D5x12 x2 31-0011	40-DIN1481 A2 D5x12 x2
15-2111	20-0200/0184	20-0200/0059	80-2002 6 мл 80-3002 2 мл 80-4001 2 мл 80-9001 1 мл	31-0011		40-DIN1481 A2 D5x12 x2	40-DIN1481 A2 D5x12 x2 31-0011
Соединение T							
15-2110	20-1051/0207	20-1080/0207	80-2002 4 мл 80-3002 1 мл 80-4001 2 мл 80-9001 1 мл			40-DIN1481 A2 D3x12 x2 40-DIN916 A2 M5x6 HEX2,5	40-DIN1481 A2 D5x12 x2 42-DIN7504M A2 4,2x16 TX20



Сечение	Артикул Наименование	I_x см ⁴	W_x см ³	S см ²
		I_y см ⁴	W_y см ³	P мм
	<p>15-2112 Рама 54 мм облегченная</p>	-	-	-
	<p>15-2121 Рама 75 мм для створки-Т компланарной</p>	$\frac{20,72}{22,17}$	$\frac{6,86}{5,06}$	$\frac{5,634}{468}$

Профиль	Сухари		Химия	Комплектующие			
	Чаша I	Чаша II		Сбивка угла на прессе		Сборка угла на штифтах	
				Чаша I	Чаша II	Чаша I	Чаша II
Соединение L							
15-2112	20-0200/0059	20-0200/0184	80-2002 6 мл 80-3002 2 мл 80-4001 2 мл 80-9001 1 мл	31-0011		40-DIN1481 A2 D5x12 x2 31-0011	40-DIN1481 A2 D5x12 x2
15-2121	20-0370/0141	20-0370/0141	80-2002 6 мл 80-3002 2 мл 80-4001 2 мл 80-9001 1 мл		31-0011	40-DIN1481 A2 D5x12 x2	40-DIN1481 A2 D5x12 x2 31-0011
Соединение T							
15-2112	20-1051/0207	20-1080/0207	80-2002 4 мл 80-3002 1 мл 80-4001 2 мл 80-9001 1 мл			40-DIN1481 A2 D3x12 x2 40-DIN916 A2 D5x12 M5x6 HEX2,5	40-DIN1481 A2 D5x12 x2 42-DIN7504M A2 4,2x16 TX20



Сечение	Артикул Наименование	I_x см ⁴	W_x см ³	S см ²
		I_y см ⁴	W_y см ³	P мм
<p>52-0150 Уплотнитель вспененный Д15 мм (опция)</p>	<p>15-2130 Рама 64 мм</p>	18,10	5,88	4,407
		11,85	3,07	397
<p>52-0150 Уплотнитель вспененный Д15 мм (опция)</p>	<p>15-2131 Рама 64 мм</p>	18,10	5,88	4,407
		11,85	3,07	397

Профиль	Сухари		Химия	Комплектующие			
	Чаша I	Чаша II		Сбивка угла на прессе		Сборка угла на штифтах	
				Чаша I	Чаша II	Чаша I	Чаша II
Соединение L							
15-2130	20-0300/0059	20-0300/0184	80-2002 6 мл 80-3002 2 мл 80-4001 2 мл 80-9001 1 мл	31-0011		40-DIN1481 A2 D5x12 x2 31-0011	40-DIN1481 A2 D5x12 x2
15-2131	20-0300/0184	20-0300/0059	80-2002 6 мл 80-3002 2 мл 80-4001 2 мл 80-9001 1 мл		31-0011	40-DIN1481 A2 D5x12 x2	40-DIN1481 A2 D5x12 x2 31-0011
Соединение T							
15-2130	20-1051/0307	20-1080/0307	80-2002 6 мл 80-3002 1 мл 80-4001 2 мл 80-9001 1 мл			40-DIN1481 A2 D3x12 x2 40-DIN916 A2 M5x6 HEX2,5	40-DIN1481 A2 D5x12 x2 42-DIN7504M A2 4,2x16 TX20
15-2131	20-1080/0307	20-1051/0307	80-2002 6 мл 80-3002 1 мл 80-4001 2 мл 80-9001 1 мл			40-DIN1481 A2 D5x12 x2 42-DIN7504M A2 4,2x16 TX20	40-DIN1481 A2 D3x12 x2 40-DIN916 A2 M5x6 HEX2,5



Сечение	Артикул Наименование	I_x см ⁴	W_x см ³	S см ²
		I_y см ⁴	W_y см ³	P мм
<p>52-0150 Уплотнитель вспененный D15 мм (опция)</p>	15-2141 Рама створки-Т в витраж	$\frac{20,10}{35,59}$	$\frac{6,63}{7,25}$	$\frac{6,357}{530}$
<p>52-0150 Уплотнитель вспененный D15 мм (опция)</p>	15-2151 Рама в витраж	$\frac{13,60}{9,41}$	$\frac{4,28}{2,61}$	$\frac{4,166}{396}$

Профиль	Сухари		Химия	Комплекующие			
	Чаша I	Чаша II		Сбивка угла на прессе		Сборка угла на штифтах	
				Чаша I	Чаша II	Чаша I	Чаша II
Соединение L							
15-2141	20-0370/0141	20-0370/0141	80-2002 6 мл 80-3002 2 мл 80-4001 2 мл 80-9001 1 мл		31-0011	40-DIN1481 A2 D5x12 x2	40-DIN1481 A2 D5x12 x2 31-0011
15-2151	20-0130/0059	20-0130/0184	80-2002 6 мл 80-3002 2 мл 80-4001 2 мл 80-9001 1 мл	31-0011		40-DIN1481 A2 D5x12 x2 31-0011	40-DIN1481 A2 D5x12 x2

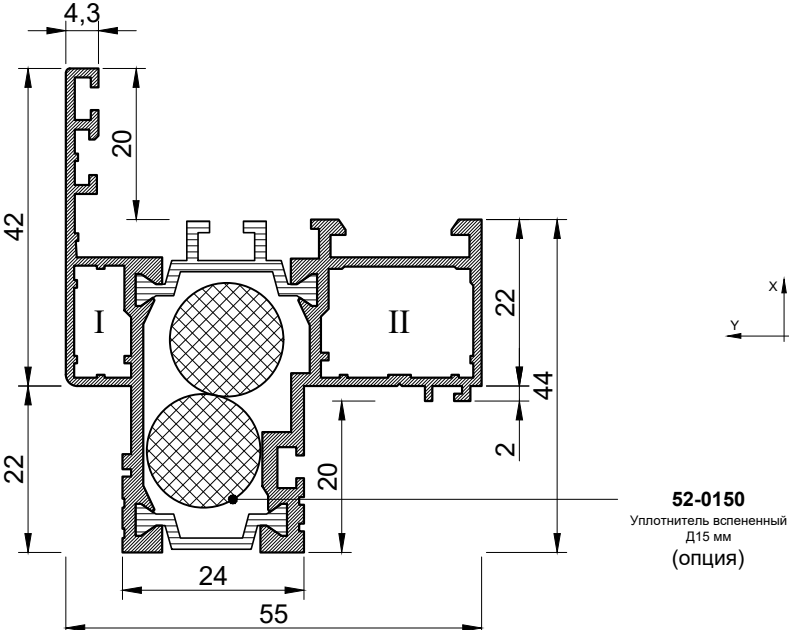
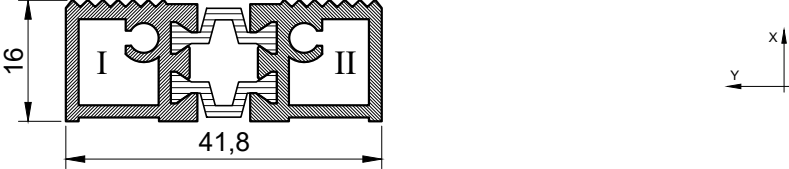

Сечение	Артикул Наименование	I_x см ⁴	W_x см ³	S см ²
		I_y см ⁴	W_y см ³	P мм
 <p>52-0150 Уплотнитель вспененный Д15 мм (опция)</p>	15-2152 Рама в витраж облегченная	-	-	-
		-	-	-
	15-2170 Порог 16 мм	$\frac{10,38}{0,711}$	$\frac{3,65}{0,84}$	$\frac{2,5}{90}$

Профиль	Сухари		Химия	Комплекующие			
	Чаша I	Чаша II		Сбивка угла на прессе		Сборка угла на штифтах	
				Чаша I	Чаша II	Чаша I	Чаша II
Соединение L							
15-2152	20-0130/0059	20-0130/0184	80-2002 6 мл 80-3002 2 мл 80-4001 2 мл 80-9001 1 мл	31-0011		40-DIN1481 A2 D5x12 x2 31-0011	40-DIN1481 A2 x2 D5x12
Соединение T							
15-2170	32-1855					43-DIN7982C A2 4,2x22 TX20 43-DIN7982C A2 4,2x45 TX20	43-DIN7982C A2 4,2x22 TX20 43-DIN7982C A2 4,2x45 TX20



Сечение	Артикул Наименование	I_x см ⁴	W_x см ³	S см ²
		I_y см ⁴	W_y см ³	P мм
	<p>15-2210 Импост 74 мм</p>	<p>18,34 11,06</p>	<p>5,80 2,99</p>	<p>4,525 411</p>
	<p>15-2212 Импост 74 мм облегченный</p>	<p>- -</p>	<p>- -</p>	<p>- -</p>

Профиль	Сухари		Химия	Комплектующие			
	Чаша I	Чаша II		Сбивка угла на прессе		Сборка угла на штифтах	
				Чаша I	Чаша II	Чаша I	Чаша II
Соединение L							
15-2210	20-0200/0059	20-0200/0086	80-2002 4 мл 80-3002 2 мл 80-4001 2 мл 80-9001 1 мл	31-0011 x2		40-DIN1481 A2 D5x12 x2 31-0011 x2	40-DIN1481 A2 D5x12 x2
15-2212	20-0200/0059	20-0200/0086	80-2002 4 мл 80-3002 2 мл 80-4001 2 мл 80-9001 1 мл	31-0011 x2		40-DIN1481 A2 D5x12 x2 31-0011 x2	40-DIN1481 A2 D5x12 x2
Соединение T							
15-2210	20-1051/0207	20-1080/0207	80-2002 4 мл 80-3002 1 мл 80-4001 2 мл 80-9001 2 мл			40-DIN1481 A2 D3x12 x2 40-DIN916 A2 M5x6 HEX2,5	40-DIN1481 A2 D5x12 x2 42-DIN7504M A2 4,2x16 TX20
15-2212	20-1051/0207	20-1080/0207	80-2002 4 мл 80-3002 1 мл 80-4001 2 мл 80-9001 2 мл			40-DIN1481 A2 D3x12 x2 40-DIN916 A2 M5x6 HEX2,5	40-DIN1481 A2 D5x12 x2 42-DIN7504M A2 4,2x16 TX20



Сечение	Артикул Наименование	I_x см ⁴	W_x см ³	S см ²
		I_y см ⁴	W_y см ³	P мм
	<p>15-2220 Импост 74 мм усиленный</p>			<p>0 0</p>

Профиль	Сухари		Химия	Комплекующие			
	Чаша I	Чаша II		Сбивка угла на прессе		Сборка угла на штифтах	
				Чаша I	Чаша II	Чаша I	Чаша II
Соединение L							
15-2220	20-0200/0059	20-0200/0086	80-2002 4 мл 80-3002 2 мл 80-4001 2 мл 80-9001 1 мл	31-0011 x2		40-DIN1481 A2 D5x12 x2 31-0011 x2	40-DIN1481 A2 D5x12 x2
Соединение T							
15-2220	20-1051/0207	20-1080/0207	80-2002 4 мл 80-3002 1 мл 80-4001 2 мл 80-9001 2 мл			40-DIN1481 A2 D3x12 x2 40-DIN916 A2 M5x6 HEX2,5	40-DIN1481 A2 D5x12 x2 42-DIN7504M A2 4,2x16 TX20



Сечение	Артикул Наименование	I_x см ⁴	W_x см ³	S см ²
		I_y см ⁴	W_y см ³	P мм
	<p>15-2221 Импост 74 мм усиленный</p>	<p>88,30 15,48</p>	<p>16,23 4,18</p>	<p>6,863 514</p>

Профиль	Сухари		Химия	Комплекующие			
	Чаша I	Чаша II		Сбивка угла на прессе		Сборка угла на штифтах	
				Чаша I	Чаша II	Чаша I	Чаша II
Соединение L							
15-2221	20-0200/0059	20-0200/0086	80-2002 4 мл 80-3002 2 мл 80-4001 2 мл 80-9001 1 мл		31-0011 x2	40-DIN1481 A2 D5x12 x2	40-DIN1481 A2 D5x12 x2 31-0011 x2
Соединение T							
15-2221	20-1080/0207	20-1051/0207	80-2002 4 мл 80-3002 1 мл 80-4001 2 мл 80-9001 2 мл			40-DIN1481 A2 D5x12 x2 42-DIN7504M A2 4,2x16 TX20	40-DIN1481 A2 D3x12 x2 40-DIN916 A2 M5x6 HEX2,5



Сечение	Артикул Наименование	I_x см ⁴	W_x см ³	S см ²
		I_y см ⁴	W_y см ³	P мм
<p>15-2230 Импост 74 мм в створку</p>				0 0
<p>15-2240 Импост 64 мм</p>				0 0

Профиль	Сухари		Химия	Комплектующие			
	Чаша I	Чаша II		Сбивка угла на прессе		Сборка угла на штифтах	
				Чаша I	Чаша II	Чаша I	Чаша II
Соединение L							
15-2240	20-0100/0059	20-0100/0086	80-2002 4 мл 80-3002 2 мл 80-4001 2 мл 80-9001 1 мл	31-0011 x2		40-DIN1481 A2 D5x8 x2 31-0011 x2	40-DIN1481 A2 D5x8 x2
Соединение T							
15-2230	20-1051/0207	20-1080/0207	80-2002 4 мл 80-3002 1 мл 80-4001 2 мл 80-9001 2 мл			40-DIN1481 A2 D3x12 x2 40-DIN916 A2 M5x6 HEX2,5 40-DIN1481 A2 D5x8 x2	40-DIN1481 A2 D5x12 x2 42-DIN7504M A2 4,2x16 TX20
15-2240	20-1051/0107	20-1080/0107	80-2002 2 мл 80-3002 1 мл 80-4001 2 мл 80-9001 2 мл			40-DIN1481 A2 D3x8 x2 40-DIN916 A2 M5x6 HEX2,5	40-DIN1481 A2 D5x8 x2 41-DIN7981C A2 4,2x9,5 TX20



Сечение	Артикул Наименование	I_x см ⁴	W_x см ³	S см ²
		I_y см ⁴	W_y см ³	P мм
<p>15-2310 Створка-Z 71 мм</p>				0 0
<p>15-2312 Створка-Z 71 мм облегченная</p>				0 0

Профиль	Сухари		Химия	Комплекующие			
	Чаша I	Чаша II		Сбивка угла на прессе		Сборка угла на штифтах	
				Чаша I	Чаша II	Чаша I	Чаша II
Соединение L							
15-2310	20-0100/0059	20-0200/0284	80-2002 7 мл 80-3002 2 мл 80-4001 2 мл 80-9001 5 мл	31-0011	31-0010	40-DIN1481 A2 D5x8 x2 31-0011	40-DIN1481 A2 D5x12 x2 31-0010
15-2312	20-0100/0059	20-0200/0284	80-2002 7 мл 80-3002 2 мл 80-4001 2 мл 80-9001 5 мл	31-0011	31-0010	40-DIN1481 A2 D5x8 x2 31-0011	40-DIN1481 A2 D5x12 x2 31-0010



Сечение	Артикул Наименование	I_x см ⁴	W_x см ³	S см ²
		I_y см ⁴	W_y см ³	P мм
<p>52-0150 Уплотнитель вспененный Д15 мм (опция)</p>	15-2313 Створка-Z 72 мм	22,81 7,08	6,44 1,93	4,209 457
<p>52-0150 Уплотнитель вспененный Д15 мм (опция)</p>	15-2320 Створка-Z 99 мм			0 0

Профиль	Сухари		Химия	Комплекующие			
	Чаша I	Чаша II		Сбивка угла на прессе		Сборка угла на штифтах	
				Чаша I	Чаша II	Чаша I	Чаша II
Соединение L							
15-2313	20-0100/0059	20-0130/0284	80-2002 7 мл 80-3002 2 мл 80-4001 2 мл 80-9001 5 мл	31-0011	31-0010	40-DIN1481 A2 D5x8 x2 31-0011	40-DIN1481 A2 D5x12 x2 31-0010
15-2320	20-0370/0059	20-0440/0284	80-2002 7 мл 80-3002 2 мл 80-4001 2 мл 80-9001 5 мл	31-0011	31-0010	40-DIN1481 A2 D5x12 x2 31-0011	40-DIN1481 A2 D5x12 x2 31-0010



Сечение	Артикул Наименование	I_x см ⁴	W_x см ³	S см ²
		I_y см ⁴	W_y см ³	P мм
	<p>15-2331 Створка-Т 102 мм</p>	<p>24,42 39,77</p>	<p>7,78 7,75</p>	<p>6,649 557</p>

Профиль	Сухари		Химия	Комплектующие			
	Чаша I	Чаша II		Сбивка угла на прессе		Сборка угла на штифтах	
				Чаша I	Чаша II	Чаша I	Чаша II
Соединение L							
15-2331	20-0440/0141	20-0440/0141	80-2002 6 мл 80-3002 2 мл 80-4001 2 мл 80-9001 1 мл	31-0011	x2	40-DIN1481 A2 D5x12 x2 31-0011 x2	40-DIN1481 A2 D5x12 x2



Сечение	Артикул Наименование	I_x см ⁴	W_x см ³	S см ²
		I_y см ⁴	W_y см ³	P мм
	<p>15-2341 Створка-Z 102 мм</p>	<p>25,28 38,18</p>	<p>8,97 7,44</p>	<p>6,649 557</p>

Профиль	Сухари		Химия	Комплектующие			
	Чаша I	Чаша II		Сбивка угла на прессе		Сборка угла на штифтах	
				Чаша I	Чаша II	Чаша I	Чаша II
Соединение L							
15-2341	20-0440/0141	20-0440/0141	80-2002 6 мл 80-3002 2 мл 80-4001 2 мл 80-9001 1 мл	31-0011	31-0011	40-DIN1481 A2 D5x12 x2 31-0011	40-DIN1481 A2 D5x12 x2 31-0011



Сечение	Артикул Наименование	I_x см ⁴	W_x см ³	S см ²
		I_y см ⁴	W_y см ³	P мм
	<p>15-2350 Створка-Т 96 мм</p>	$\frac{34,13}{41,99}$	$\frac{9,23}{8,60}$	$\frac{7,099}{684}$
	<p>15-2411 Штульп 57 мм дверной</p>	$\frac{15,36}{6,07}$	$\frac{4,05}{1,82}$	$\frac{4,151}{384}$

Профиль	Сухари		Химия	Комплектующие			
	Чаша I	Чаша II		Сбивка угла на прессе		Сборка угла на штифтах	
				Чаша I	Чаша II	Чаша I	Чаша II
Соединение L							
15-2350	20-0440/0265	20-0440/0095	80-2002 7 мл 80-3002 2 мл 80-4001 2 мл 80-9001 1 мл	31-0011 31-0010		40-DIN1481 A2 x2 D5x12 31-0011 31-0010	40-DIN1481 A2 x2 D5x12



Сечение	Артикул Наименование	I_x см ⁴	W_x см ³	S см ²
		I_y см ⁴	W_y см ³	P мм
	<p>15-2412 Штульп 57 мм</p>	$\frac{16,23}{7,37}$	$\frac{4,05}{2,13}$	$\frac{4,430}{410}$
	<p>15-2431 Профиль обрачивающий створки-Т компланарной</p>	$\frac{11,78}{5,62}$	$\frac{4,28}{1,77}$	$\frac{3,749}{347}$
<p>52-0150 Уплотнитель вспененный Д15 мм (опция)</p>	<p>15-2441 Профиль обрачивающий</p>	$\frac{13,06}{5,02}$	$\frac{4,15}{1,60}$	$\frac{3,651}{318}$

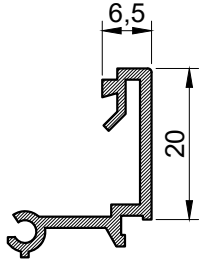
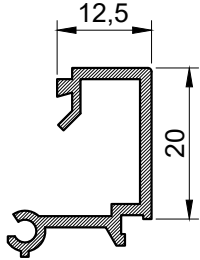
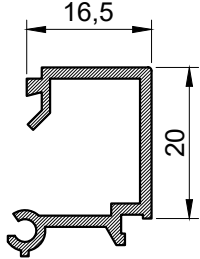
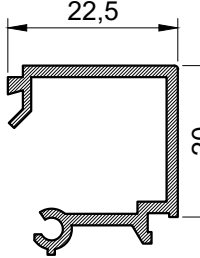
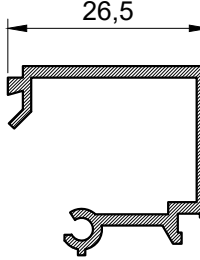
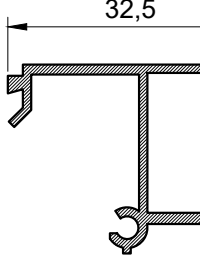

Сечение	Артикул Наименование	I_x см ⁴	W_x см ³	S см ²
		I_y см ⁴	W_y см ³	P мм
	10-6060 Штапик 6,5 x 20 мм			0,84 123
	10-6120 Штапик 12,5 x 20 мм			0,94 135
	10-6160 Штапик 16,5 x 20 мм			1 143
	10-6220 Штапик 22,5 x 20 мм			1,08 155
	10-6260 Штапик 26,5 x 20 мм			1,14 163
	10-6320 Штапик 32,5 x 20 мм			0 0

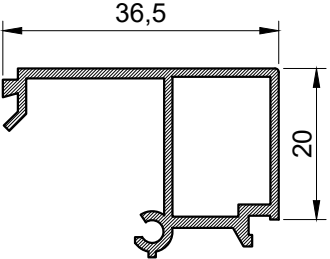
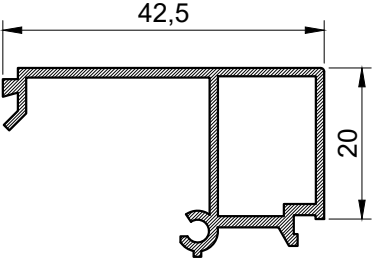

Сечение	Артикул Наименование	I_x см ⁴ I_y см ⁴	W_x см ³ W_y см ³	S см ² P мм
	<p>10-6360 Штапик 36,5 x 20 мм</p>			<p>0 0</p>
	<p>10-6420 Штапик 42,5 x 20 мм</p>			<p>0 0</p>

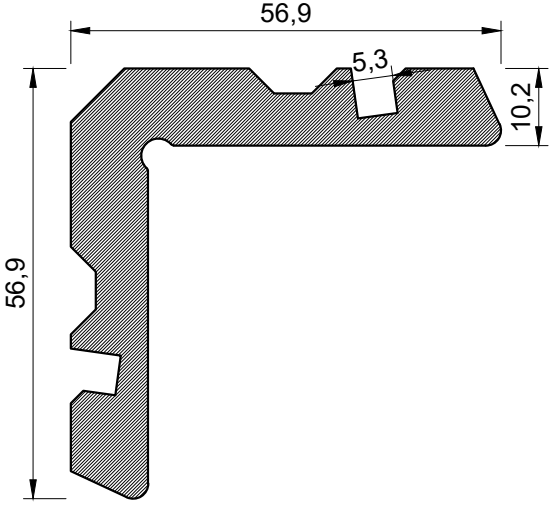
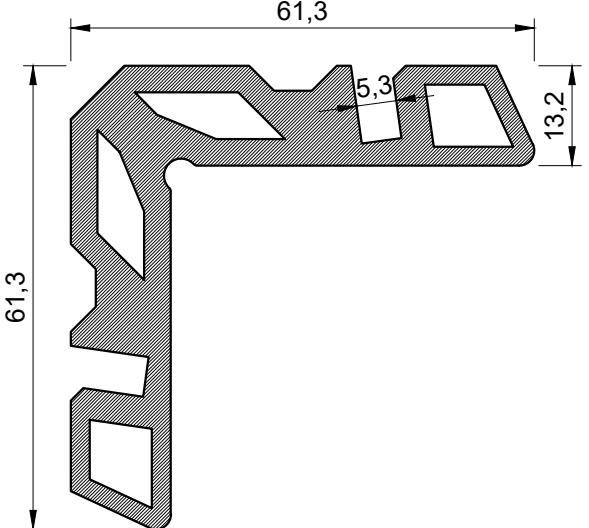
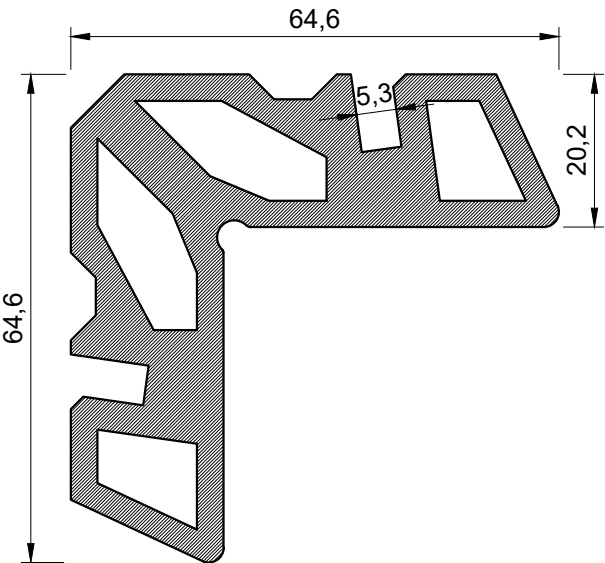

Сечение	Артикул Наименование	I_x см ⁴ I_y см ⁴	W_x см ³ W_y см ³	S см ² P мм
	<p>10-0100 Сухарь 10,2 мм</p>			<p>0,00 000</p>
	<p>10-0130 Сухарь 13,2 мм</p>			<p>89,9 271</p>
	<p>10-0200 Сухарь 20,2 мм</p>			<p>125 279</p>

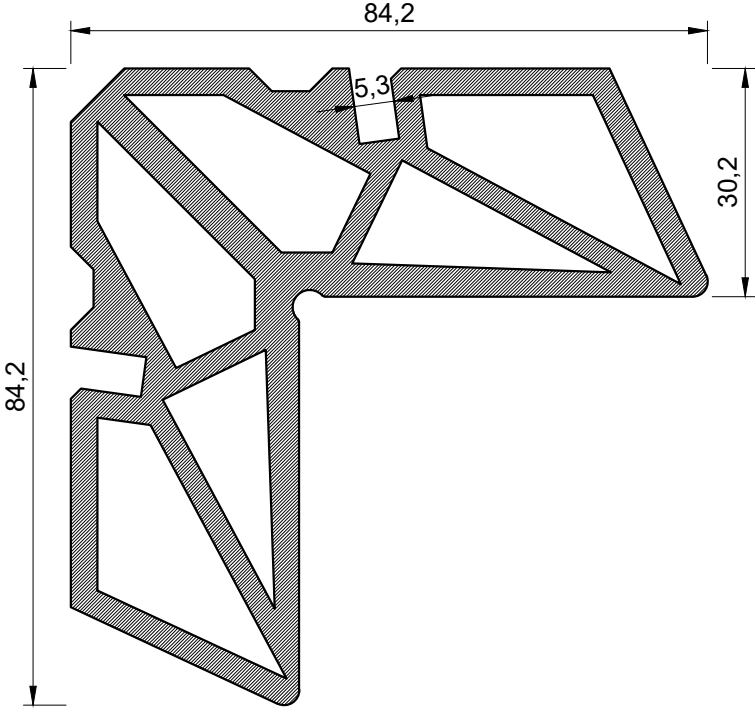
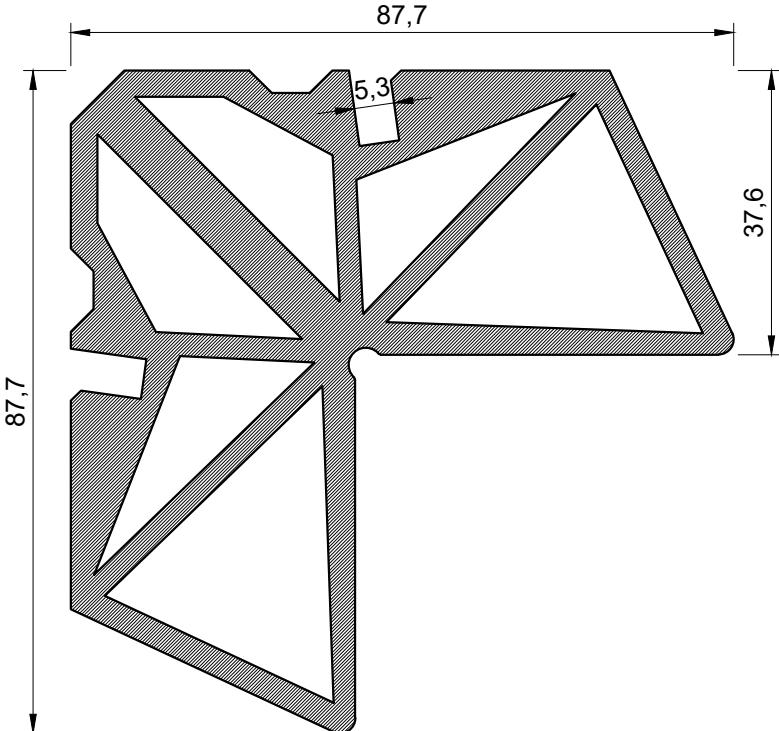

Сечение	Артикул Наименование	I_x см ⁴ I_y см ⁴	W_x см ³ W_y см ³	S см ² P мм
	<p>10-0300 Сухарь 30,2 мм</p>			<p>0 0</p>
	<p>10-0370 Сухарь 37,6 мм</p>			<p>208 358</p>

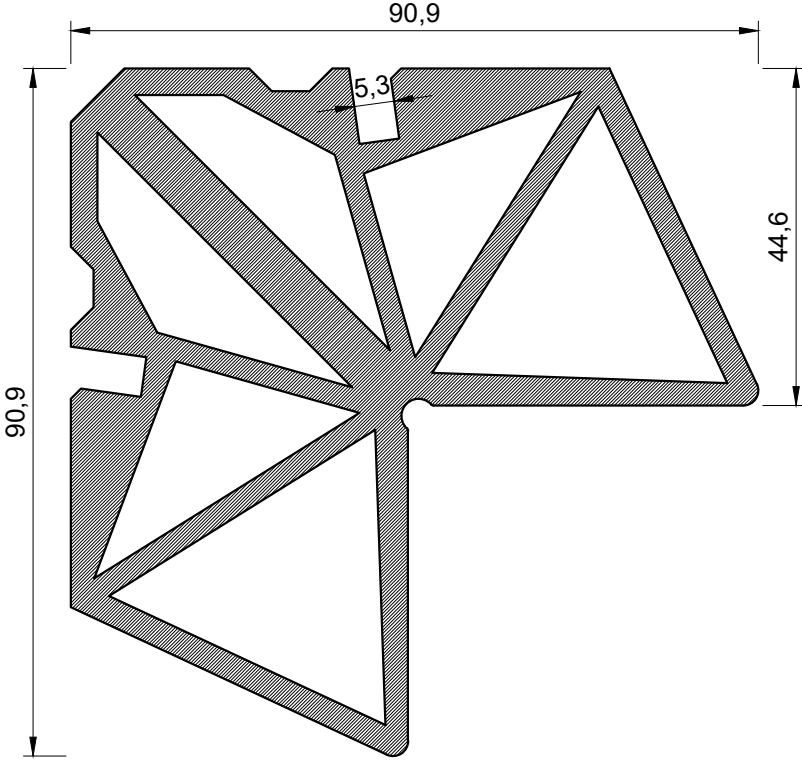

Сечение	Артикул Наименование	I_x см ⁴ I_y см ⁴	W_x см ³ W_y см ³	S см ² P мм
	<p>10-0440 Сухарь 44,6 мм</p>			<p>224 366</p>

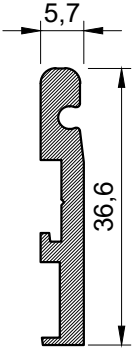
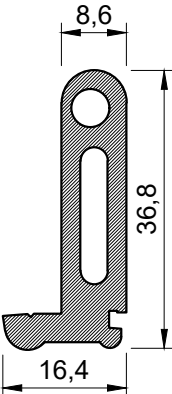
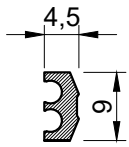
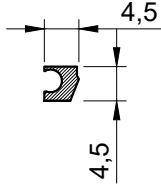

Сечение	Артикул Наименование	I_x см ⁴ I_y см ⁴	W_x см ³ W_y см ³	S см ² P мм
	<p>10-1051 Сухарь 5,7 мм крепления импоста</p>			$\frac{1,3987}{97}$
	<p>10-1080 Сухарь 8,6 мм крепления импоста</p>			$\frac{2,432}{104}$
	<p>10-5060 Профиль стыковочный</p>			$\frac{2,9}{35}$
	<p>10-5050 Профиль крепления мембраны</p>			$\frac{1,4}{22}$



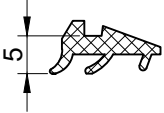
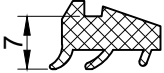
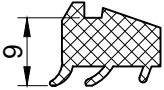
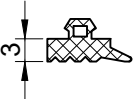
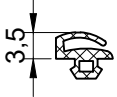
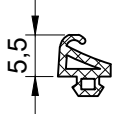
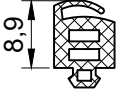
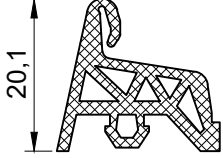
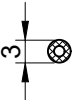
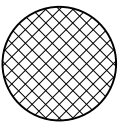



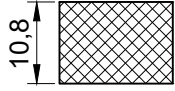



















Сечение	Ед. Изм.	Н.У.	Артикул Наименование
	пог. м	250	50-1250 Уплотнитель под штапик 5 мм
	пог. м	200	50-1270 Уплотнитель под штапик 7 мм
	пог. м	200	50-1290 Уплотнитель под штапик 9 мм
	пог. м	300	50-2030 Уплотнитель под СП 3 мм
	пог. м	400	50-3030 Уплотнитель притвора 3,5 мм
	пог. м	400	50-3051 Уплотнитель притвора 5,5 мм
	пог. м	250	50-3080 Уплотнитель притвора 8,9 мм
	пог. м	60	50-4520 Уплотнитель центральный WD55
	пог. м	500	50-7010 Уплотнитель круглый Д3 мм
	пог. м	500	52-0150 Уплотнитель вспененный Д15 мм











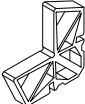

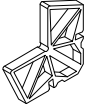

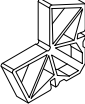

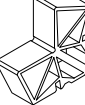

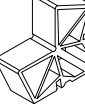



Сечение	Ед. Изм.	Н.У.	Артикул Наименование
	пог. м	25	52-2001 ПСУЛ 15x5 мм



Сечение	Внешний вид	Ед. Изм.	Н.У.	Артикул Наименование
		шт.	1	20-0100/0059 Сухарь 10,2 мм х5,9 мм
		шт.	1	20-0100/0086 Сухарь 10,2 мм х8,6 мм
		шт.	1	20-0130/0059 Сухарь 13,2 мм х5,9 мм
		шт.	1	20-0130/0184 Сухарь 13,2 мм х18,4 мм
		шт.	1	20-0130/0284 Сухарь 13,2 мм х28,4 мм
		шт.	1	20-0200/0059 Сухарь 20,2 мм х5,9 мм
		шт.	1	20-0200/0086 Сухарь 20,2 мм х8,6 мм
		шт.	1	20-0200/0184 Сухарь 20,2 мм х18,4 мм
		шт.	1	20-0200/0284 Сухарь 20,2 мм х28,4 мм
		шт.	1	20-0300/0059 Сухарь 30,2 мм х5,9 мм
		шт.	1	20-0300/0184 Сухарь 30,2 мм х18,4 мм
		шт.	1	20-0370/0059 Сухарь 37,6 мм х5,9 мм





























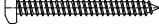

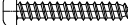

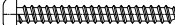

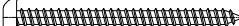
Сечение	Внешний вид	Ед. Изм.	Н.У.	Артикул Наименование
		шт.	1	20-0370/0141 Сухарь 37,6 мм x14,1 мм
		шт.	1	20-0440/0095 Сухарь 44,6 мм x9,5 мм
		шт.	1	20-0440/0141 Сухарь 44,6 мм x14,1 мм
		шт.	1	20-0440/0265 Сухарь 44,6 мм x26,5 мм
		шт.	1	20-0440/0284 Сухарь 44,6 мм x28,4 мм
		шт.	1	20-1051/0107 Сухарь 5,7 мм x10,7 мм
		шт.	1	20-1051/0207 Сухарь 5,7 мм x20,7 мм
		шт.	1	20-1051/0307 Сухарь 5,7 мм x30,7 мм
		шт.	1	20-1080/0107 Сухарь 8,6 мм x10,7 мм
		шт.	1	20-1080/0207 Сухарь 8,6 мм x20,7 мм
		шт.	1	20-1080/0307 Сухарь 8,6 мм x30,7 мм













Сечение	Внешний вид	Ед. Изм.	Н.У.	Артикул Наименование
		шт.	1	31-0010 Уголок выравнивающий
		шт.	1	31-0011 Уголок выравнивающий
		шт.	1	32-0001 Вставка Д7,5 мм под шуруп 3,9 мм
		шт.	1	32-0020 Крышка дренажная оконная
		шт.	1	32-1510 Заглушка Д10 мм
		шт.	1	32-1643 Опора СП 43 мм
		пара.	1	32-1855 Комплект креплений порога WD55
		шт.	1	32-6285 Пластина рихтовочная 28x5 мм
		шт.	1	32-6402 Пластина рихтовочная 40x2 мм
		компл.	1	33-1955 Комплект заглушек штульпа WD55
		компл.	1	33-2055 Комплект заглушек штульпа WD55
		пог. м	6,5	65-1003 Профиль базы

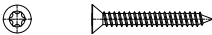

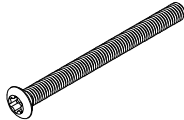

Сечение	Внешний вид	Ед. Изм.	Н.У.	Артикул Наименование
 		шт.		40-DIN916 A2 M5x6 HEX2,5 Винт установочный с кантом
 		шт.		40-DIN1481 A2 D3x8 Штифт
 		шт.		40-DIN1481 A2 D3x12 Штифт
 		шт.		40-DIN1481 A2 D5x8 Штифт
 		шт.		40-DIN1481 A2 D5x12 Штифт
 		шт.		41-DIN7981C A2 3,9x13 TX15 Шуруп с полукруглой головкой
 		шт.		41-DIN7981C A2 4,2x38 TX20 Шуруп с полукруглой головкой
 		шт.		41-DIN7981C A2 4,8x32 TX25 Шуруп с полукруглой головкой
 		шт.		41-DIN7981C A2 4,8x45 TX25 Шуруп с полукруглой головкой
 		шт.		41-DIN7981C A2 4,8x60 TX25 Шуруп с полукруглой головкой
 		шт.		42-DIN7504M A2 4,2x16 TX20 Шуруп сверлоконечный с полукруглой головкой
 		шт.		43-DIN7982C A2 3,9x13 TX15 Шуруп с потайной головкой

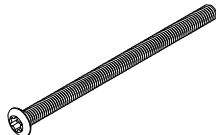

Сечение	Внешний вид	Ед. Изм.	Н.У.	Артикул Наименование
		шт.		43-DIN7982C A2 3,9x16 TX15 Шуруп с потайной головкой
		шт.		43-DIN7982C A2 3,9x25 TX15 Шуруп с потайной головкой
		шт.		43-DIN7982C A2 3,9x32 TX15 Шуруп с потайной головкой
		шт.		46-DIN965 Zn M5x16 TX25 Винт с потайной головкой
		шт.		46-DIN966 A2 M5x70 TX25 Винт с полупотайной головкой
		шт.		46-DIN966 A2 M5x80 TX25 Винт с полупотайной головкой

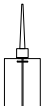
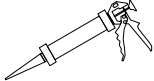

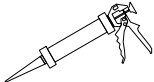
Сечение	Внешний вид	Ед. Изм.	Н.У.	Артикул Наименование
		шт.	1	80-2002 Клей двухкомпонентный Cosmofen DUO
		шт.	1	80-3002 Клей-герметик полиуретановый черный COSMO HD-100.412
		шт.	1	80-4001 Очиститель Cosmofen 60
		шт.	1	80-9001 Клей-герметик для ЭПДМ SikaBond TF Plus N



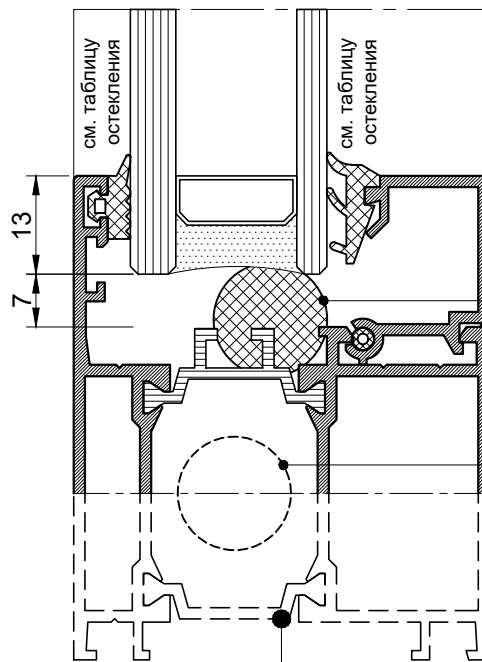
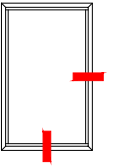

52-0150
Уплотнитель вспененный
Д15 мм
(опция)

52-0150
Уплотнитель вспененный
Д15 мм
(опция)
Количество
см. в разделе 02

15-2110 15-2112 15-2130 15-2151 15-2152 15-2210 15-2212 15-2220 15-2221 15-2240

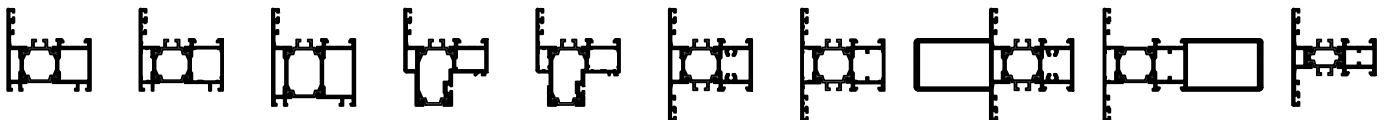

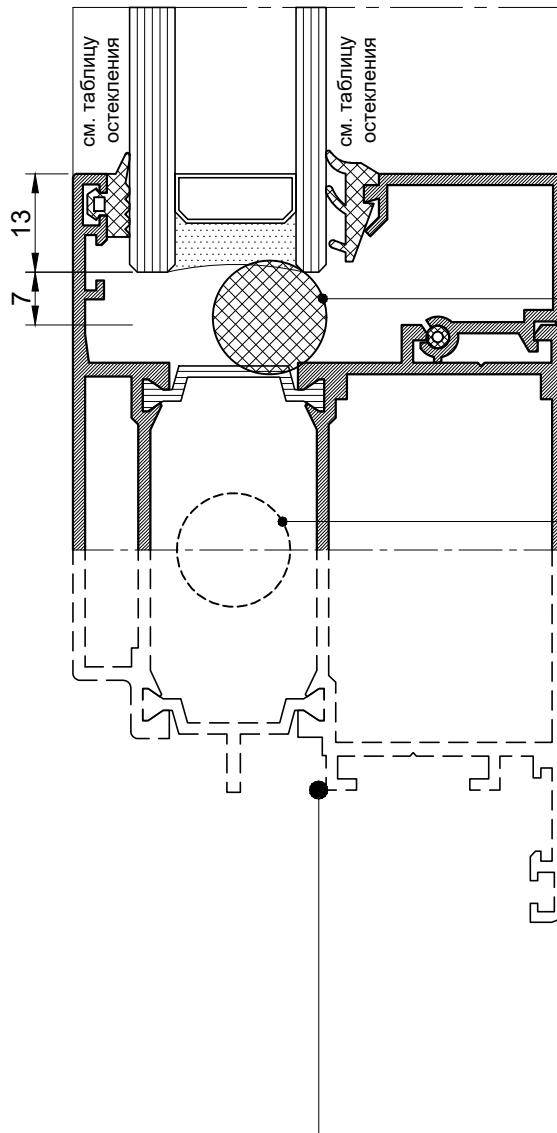
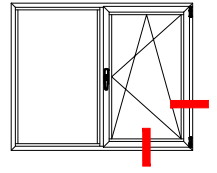

52-0150
Уплотнитель вспененный
Д15 мм
(опция)

52-0150
Уплотнитель вспененный
Д15 мм
(опция)

Количество
см. в разделе 02

15-2230

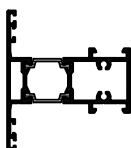

15-2310

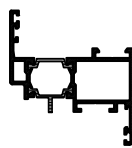

15-2312

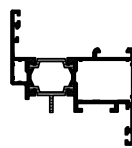

15-2313

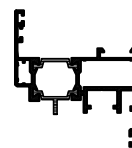

15-2320

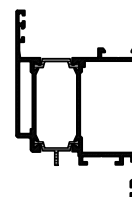

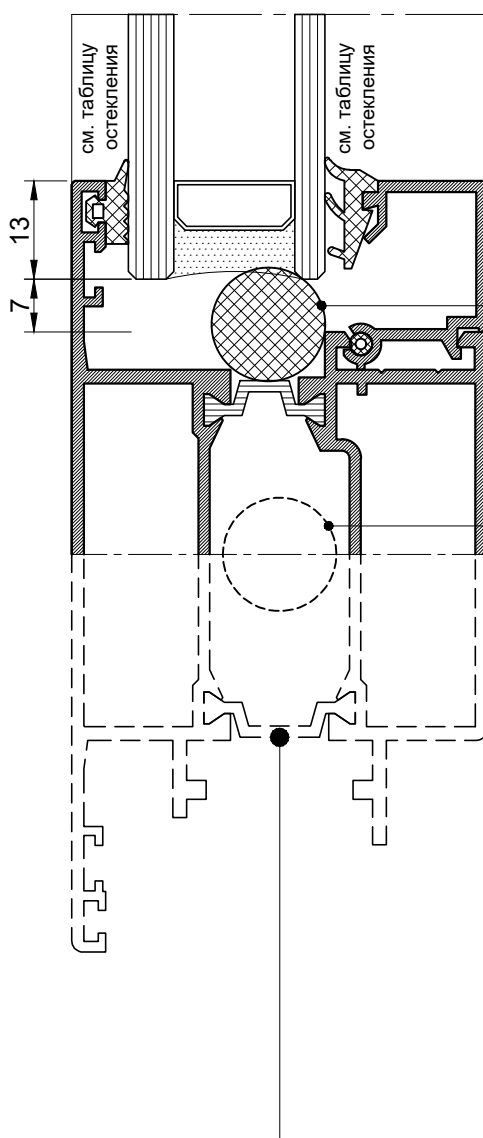
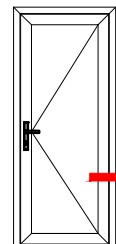

52-0150
Уплотнитель вспененный
Д15 мм
(опция)

52-0150
Уплотнитель вспененный
Д15 мм
(опция)

Количество
см. в разделе 02

15-2331

15-2341

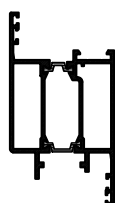
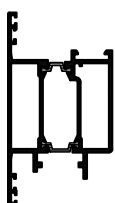

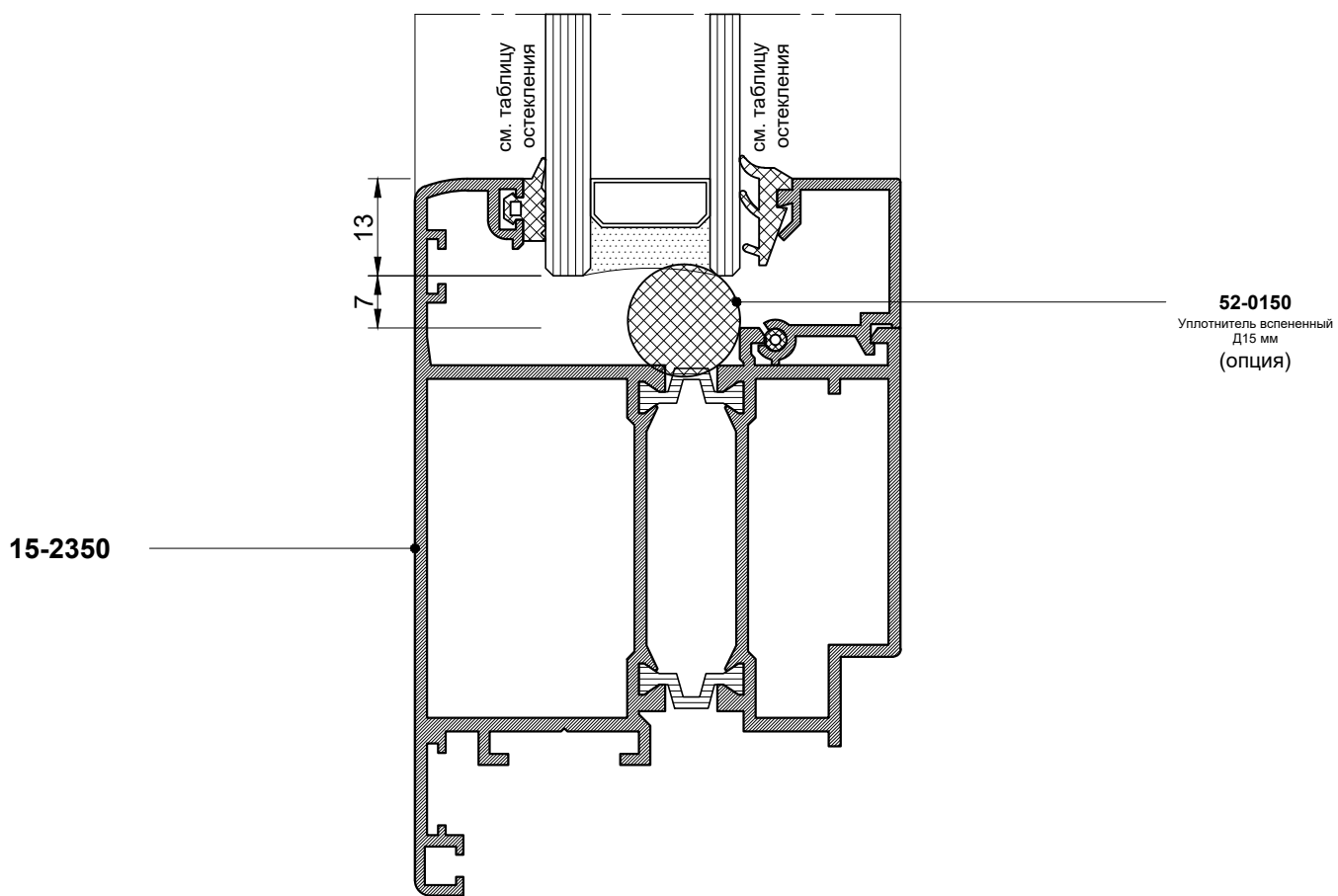
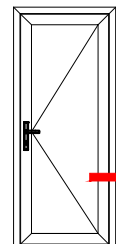

15-2310 15-2312 15-2320

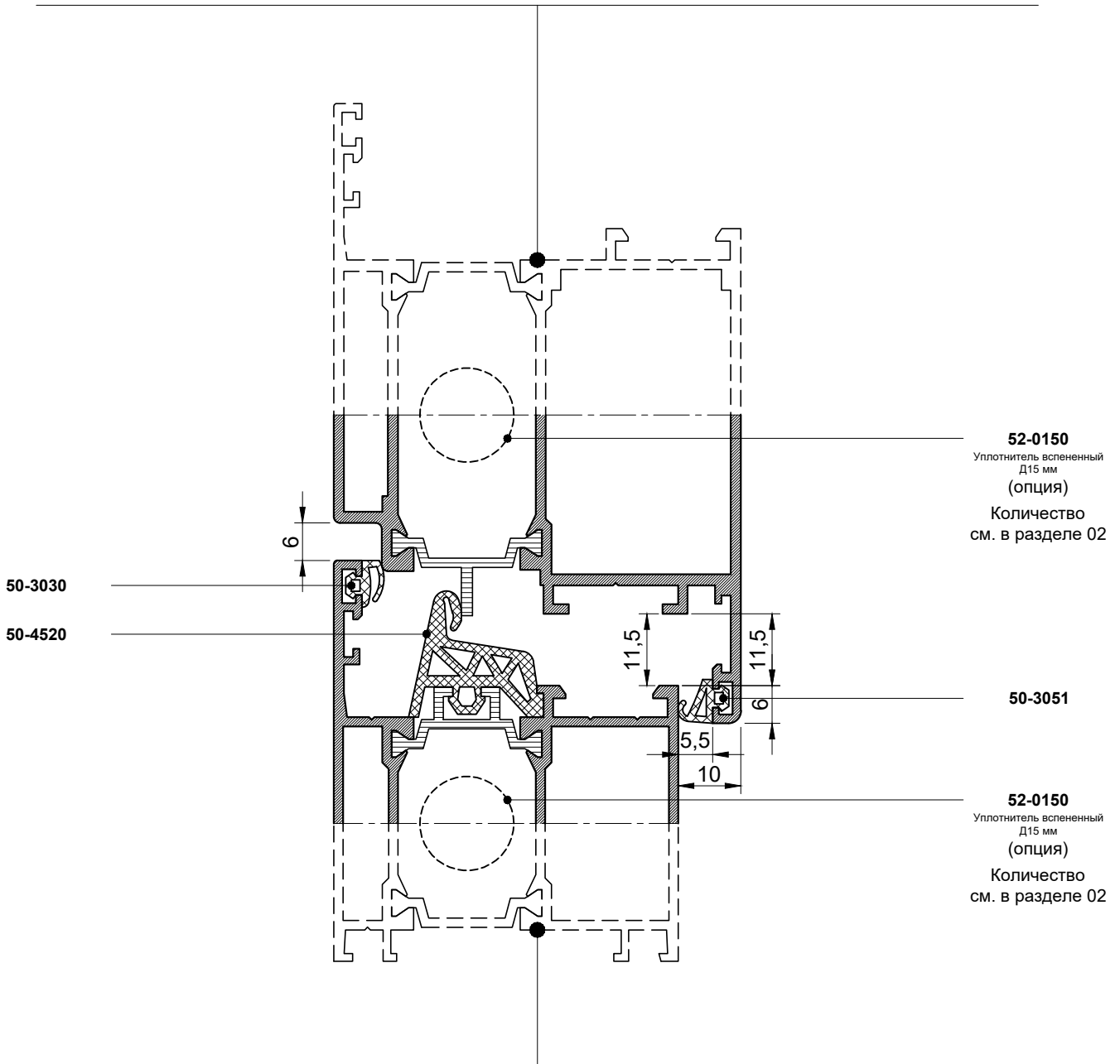
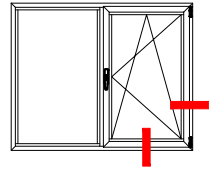
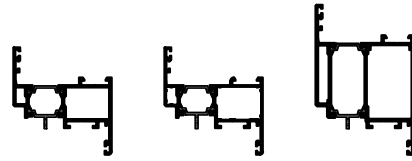

15-2110 15-2112 15-2130 15-2151 15-2152 15-2210 15-2212 15-2220 15-2240 15-2221

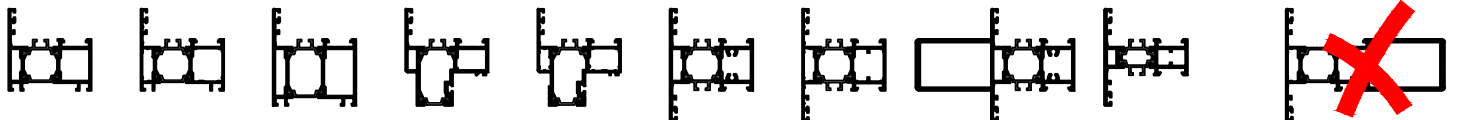

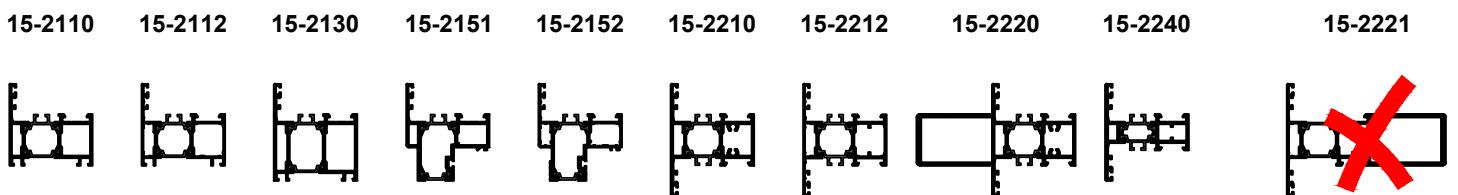
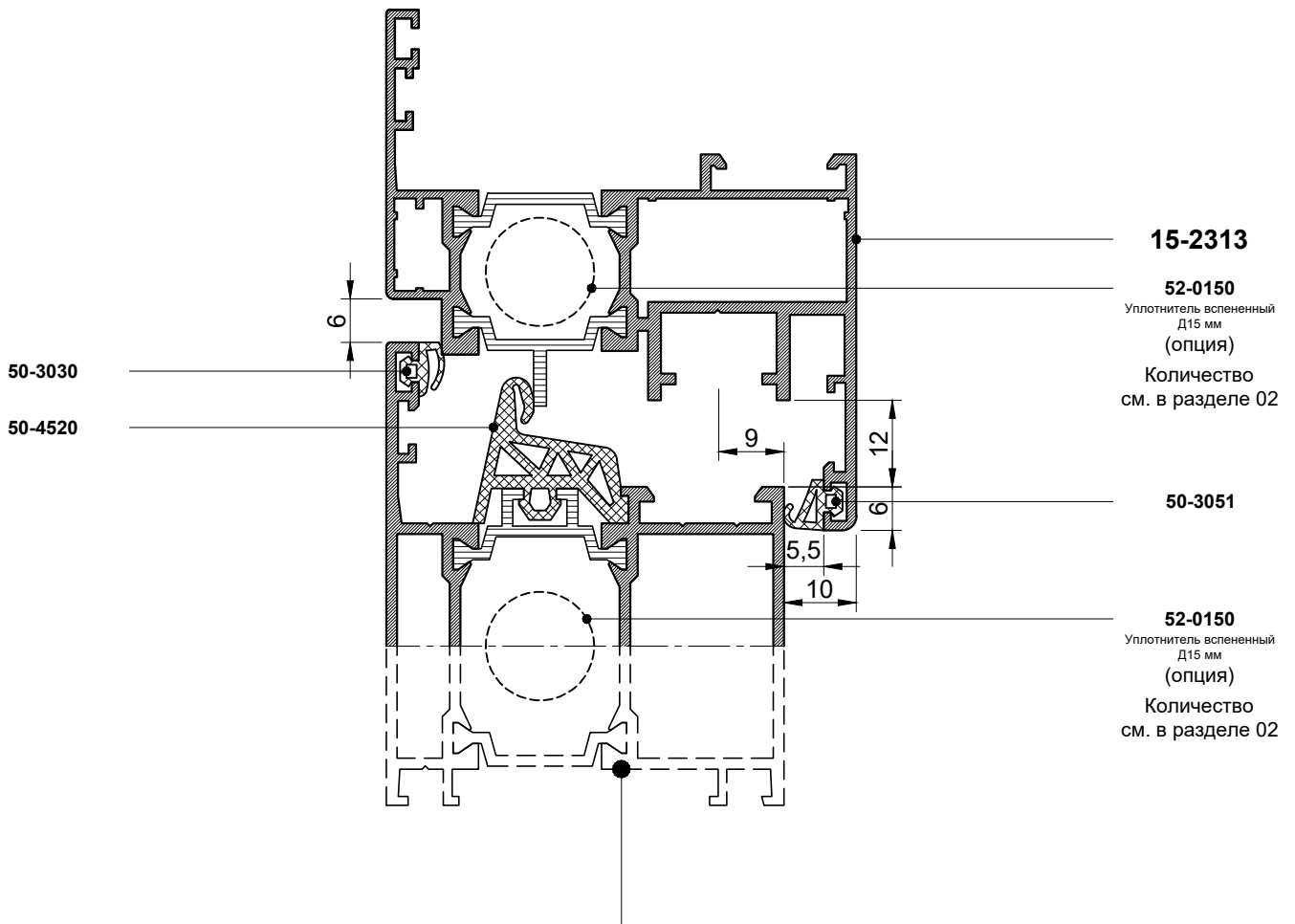
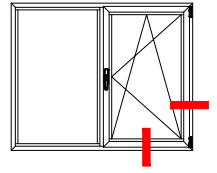

15-2310

15-2312

15-2313

15-2320

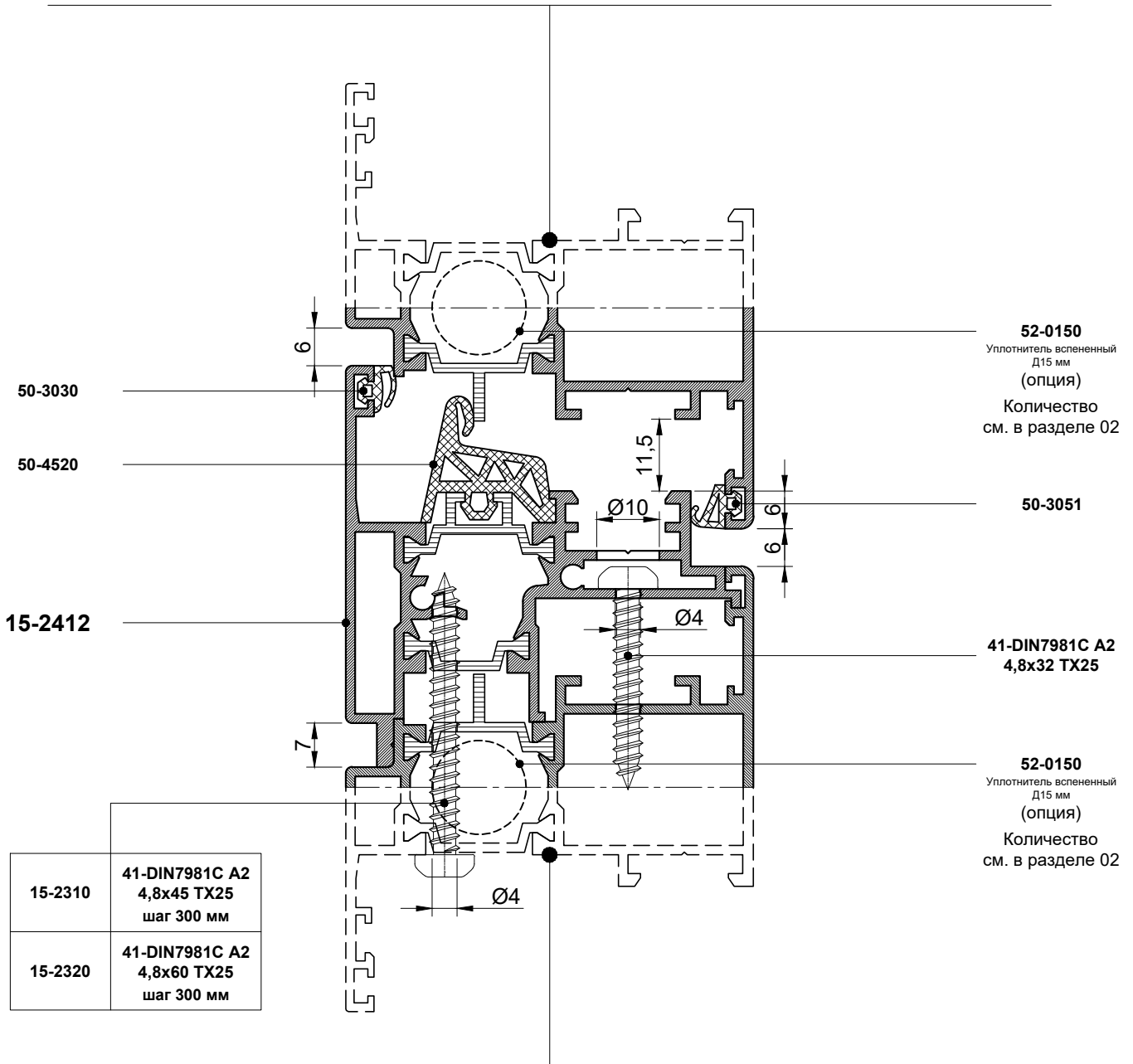
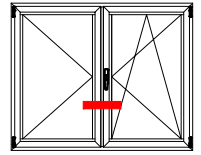
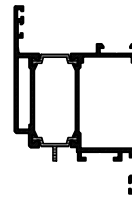
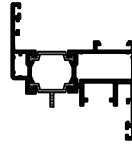
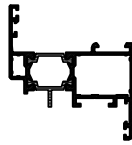
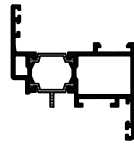

15-2310

15-2312

15-2320

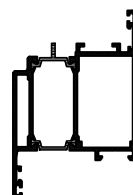
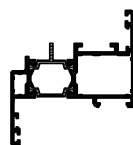
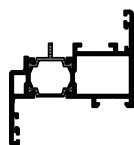

15-2110

15-2111

15-2112

15-2121

15-2130

15-2131

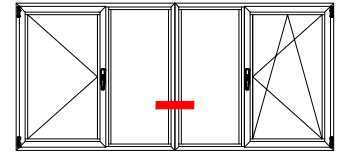
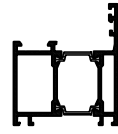
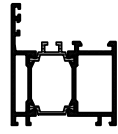
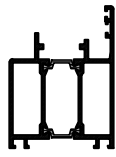
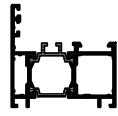
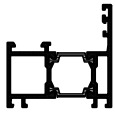
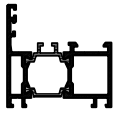

52-2001

10-5060

50-7010

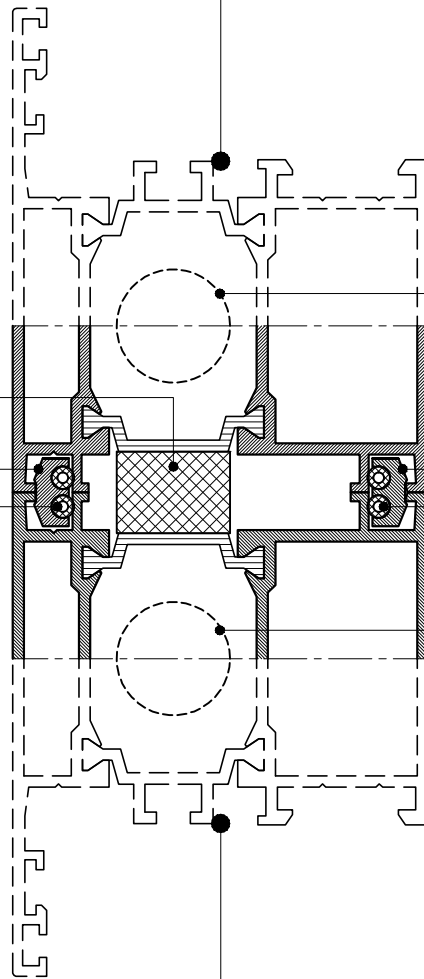

52-0150

Уплотнитель вспененный
Д15 мм
(опция)

Количество
см. в разделе 02

10-5060

50-7010

52-0150

Уплотнитель вспененный
Д15 мм
(опция)

Количество
см. в разделе 02

15-2110

15-2111

15-2112

15-2121

15-2130

15-2131

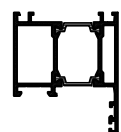
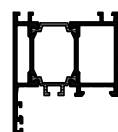
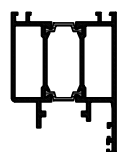
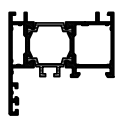
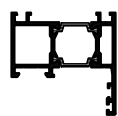
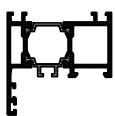

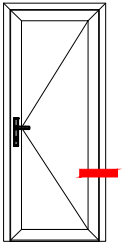

15-2331

50-3080

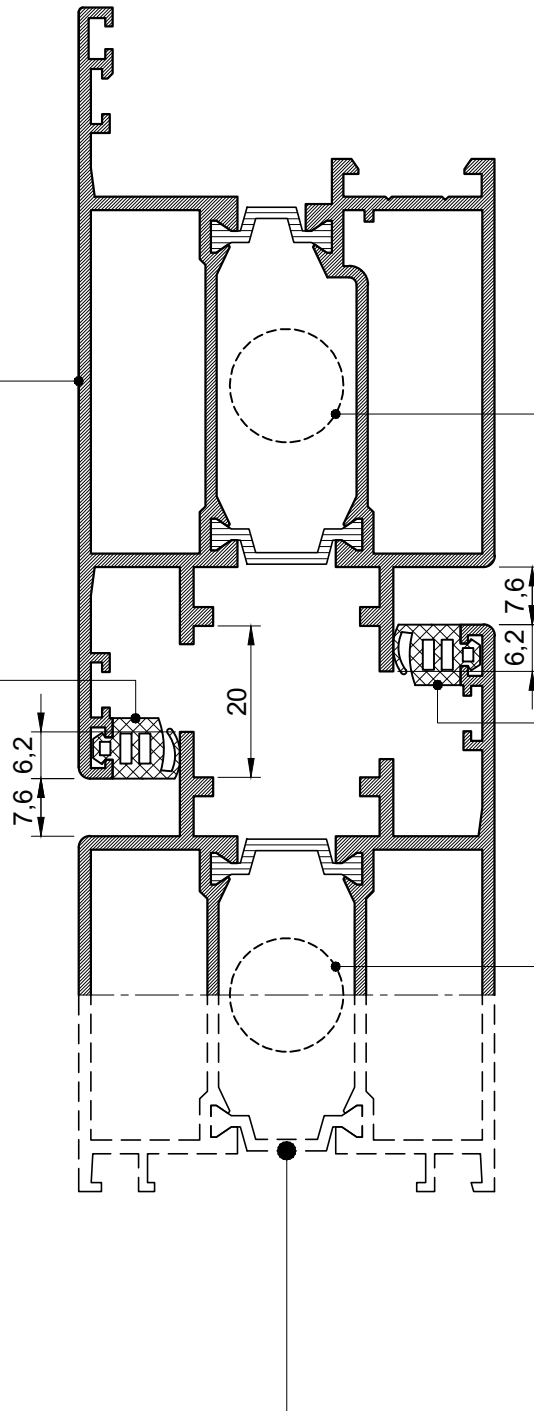

52-0150

Уплотнитель вспененный
Д15 мм
(опция)

Количество
см. в разделе 02

50-3080

52-0150

Уплотнитель вспененный
Д15 мм
(опция)

Количество
см. в разделе 02

15-2121

15-2141

15-2341

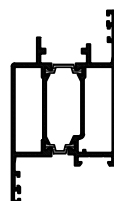
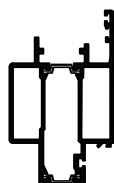
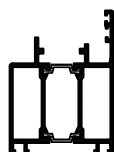

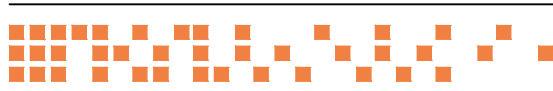
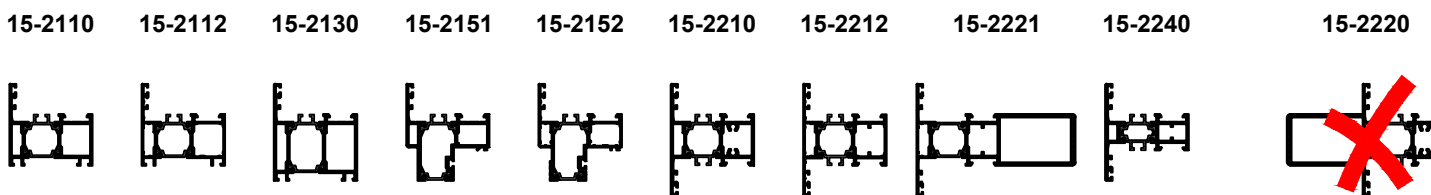
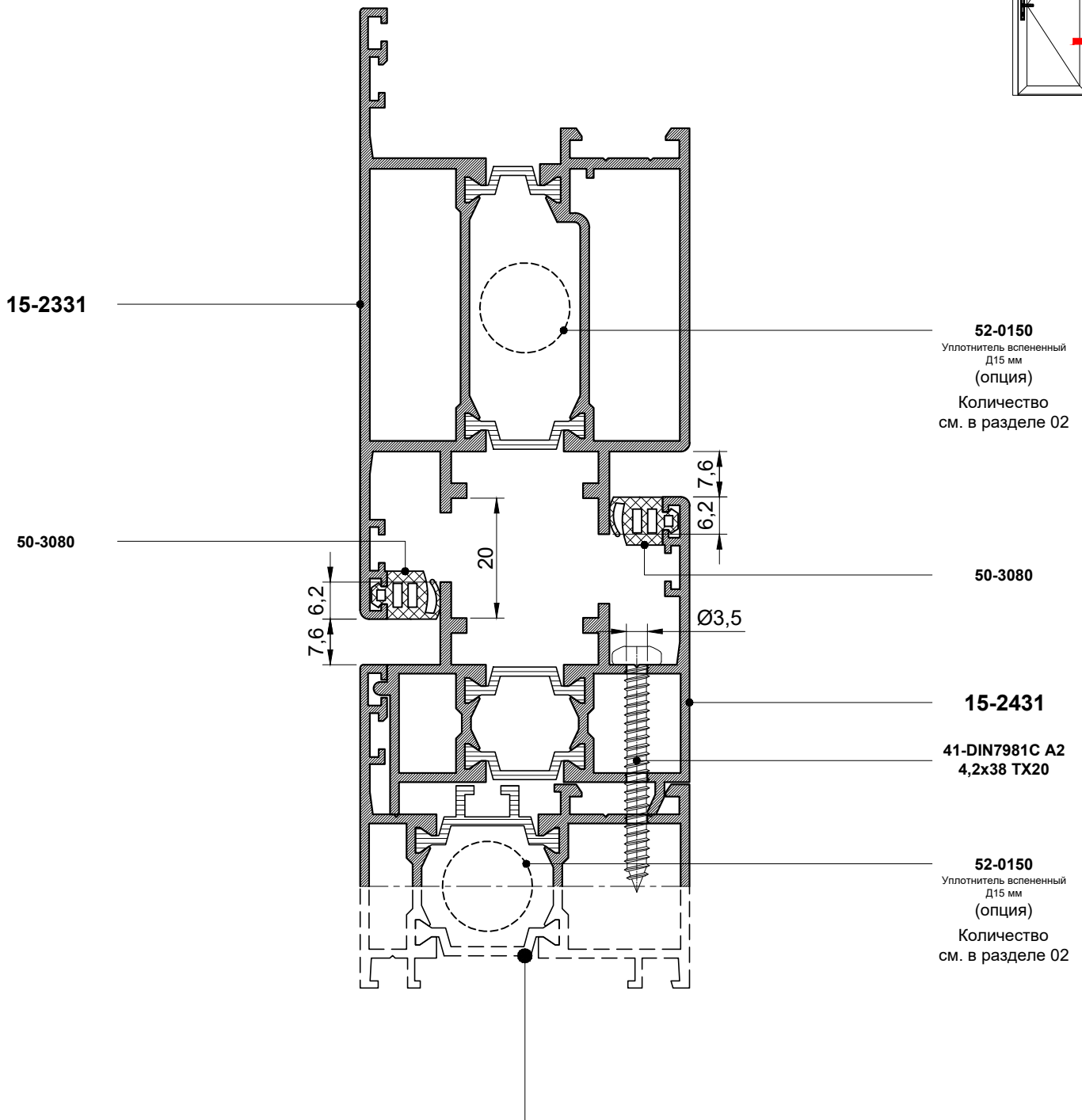
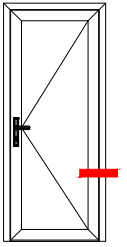

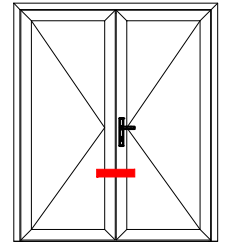

15-2331

52-0150
Уплотнитель вспененный
Д15 мм
(опция)
Количество
см. в разделе 02

50-3080

50-3080

15-2341

52-0150
Уплотнитель вспененный
Д15 мм
(опция)
Количество
см. в разделе 02

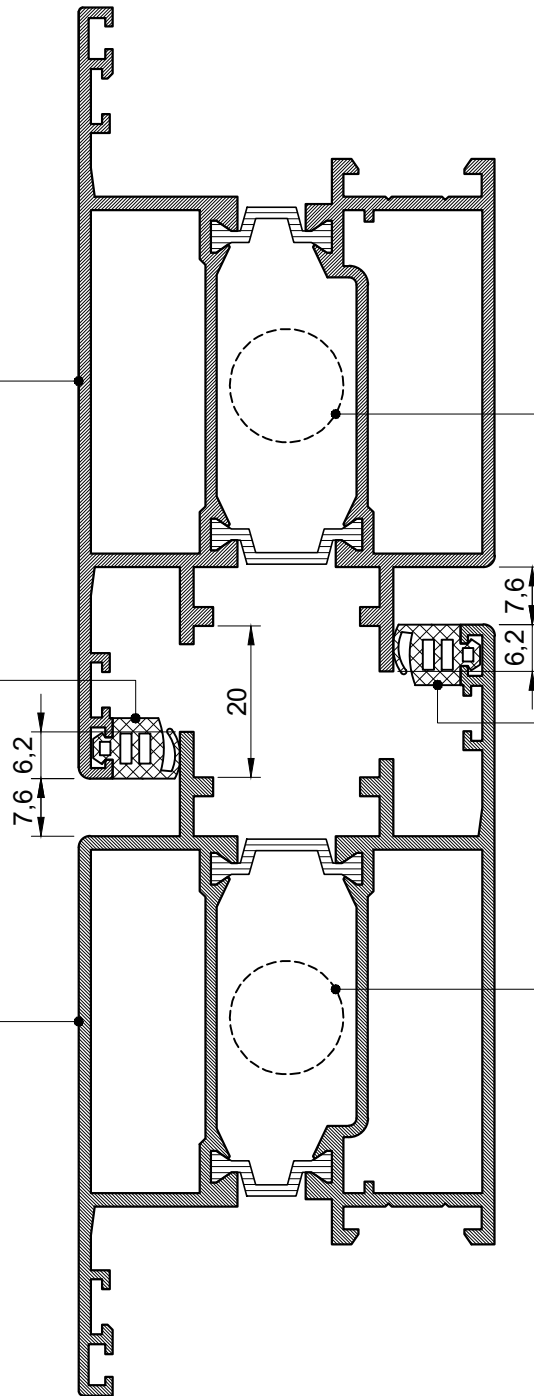

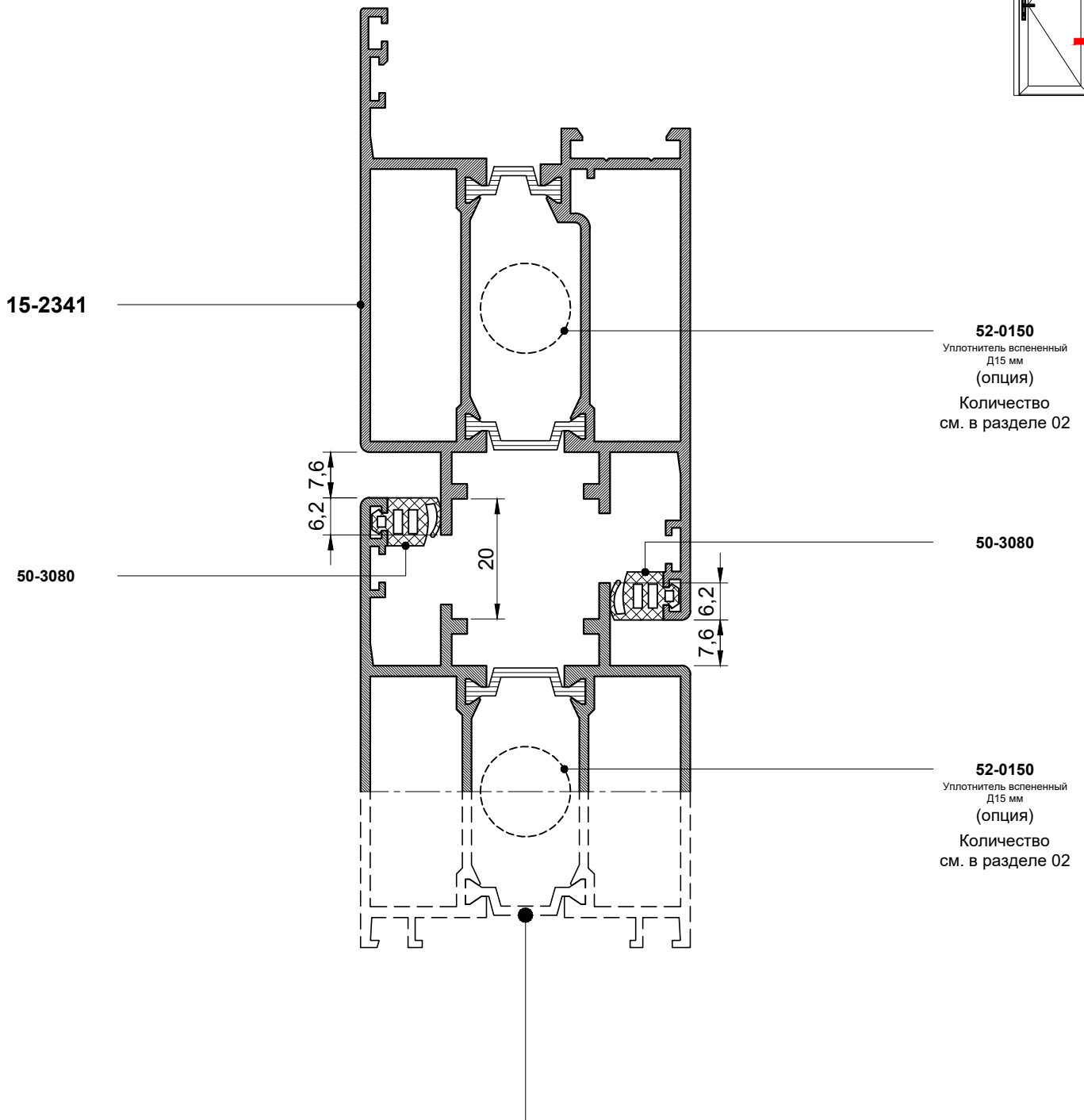
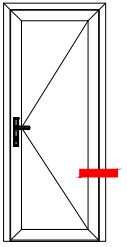

15-2121

15-2331

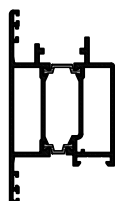
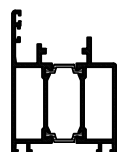

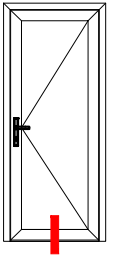

15-2331

50-3080

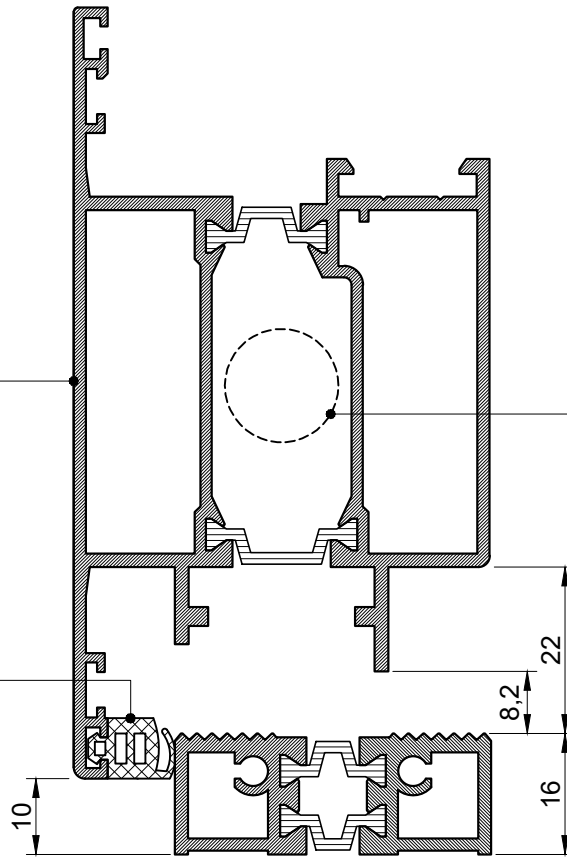

52-0150
Уплотнитель вспененный
Д15 мм
(опция)
Количество
см. в разделе 02



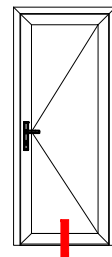

15-2331

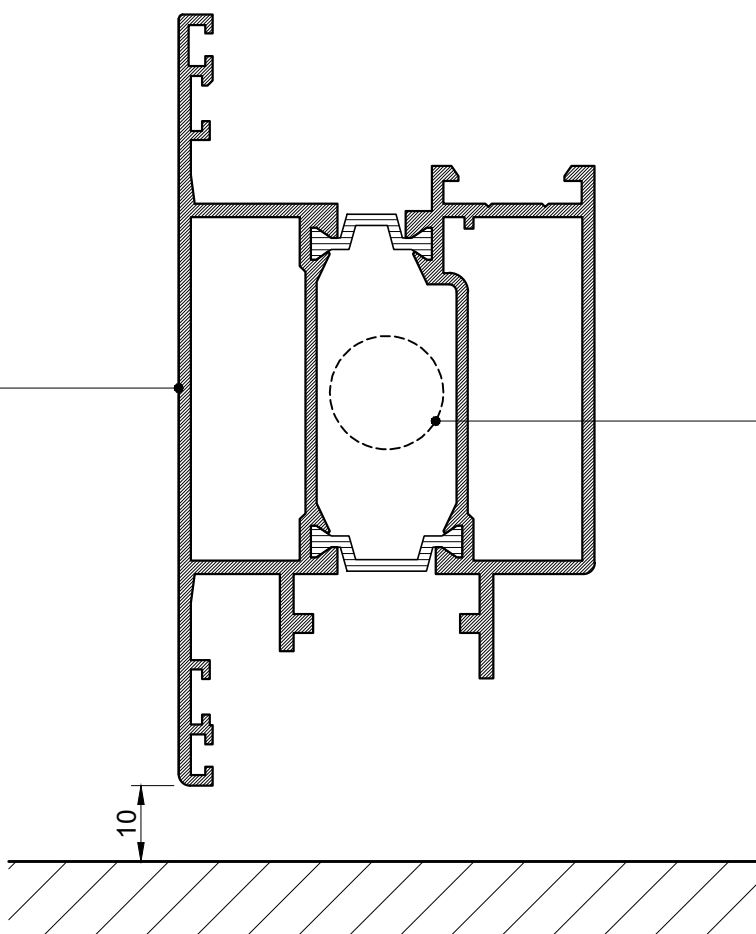

52-0150
Уплотнитель вспененный
Д15 мм
(опция)
Количество
см. в разделе 02



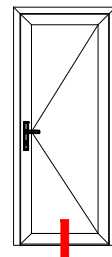

15-2341

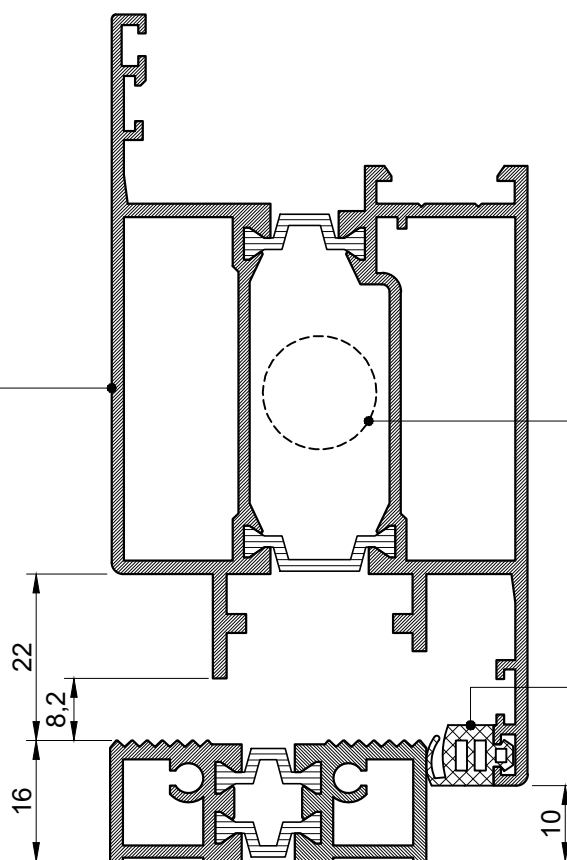

52-0150
Уплотнитель вспененный
Д15 мм
(опция)
Количество
см. в разделе 02

50-3080



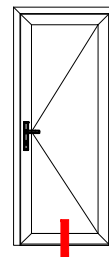

15-2341

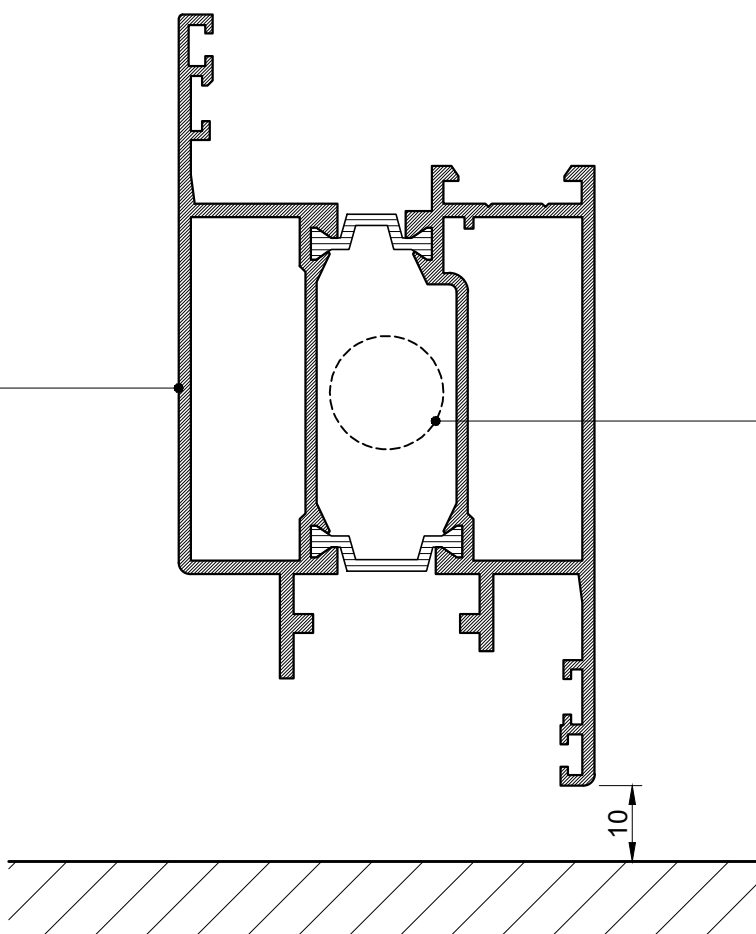

52-0150
Уплотнитель вспененный
Д15 мм
(опция)
Количество
см. в разделе 02



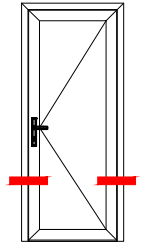

15-2350

50-3030

50-3030

52-0150

Уплотнитель вспененный
Д15 мм
(опция)

Количество
см. в разделе 02

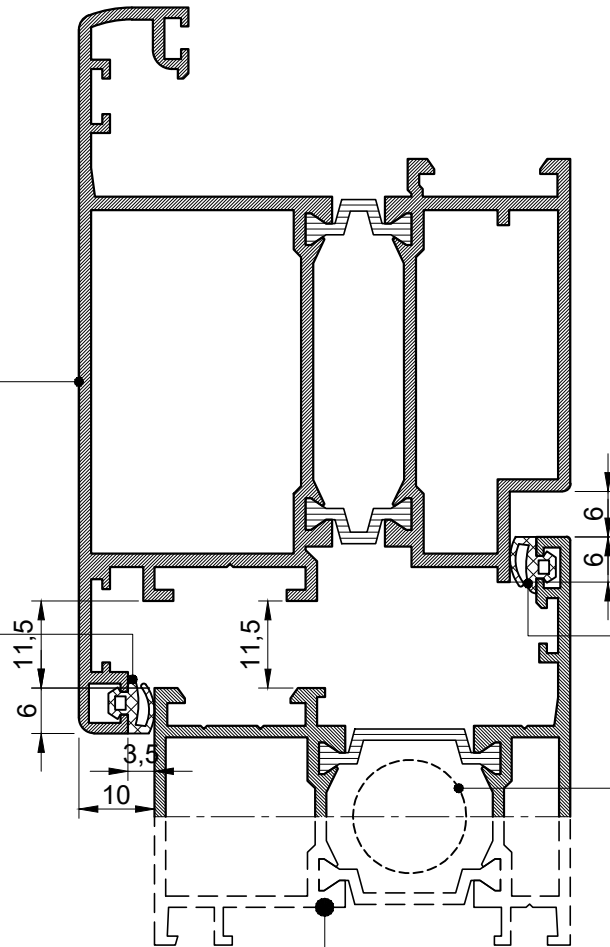

15-2111

15-2131

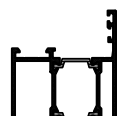
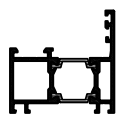

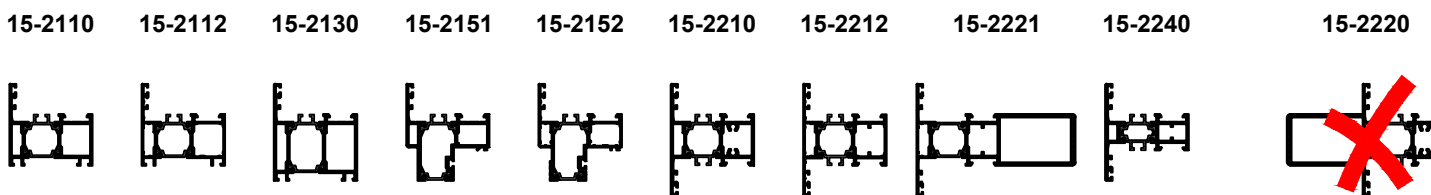
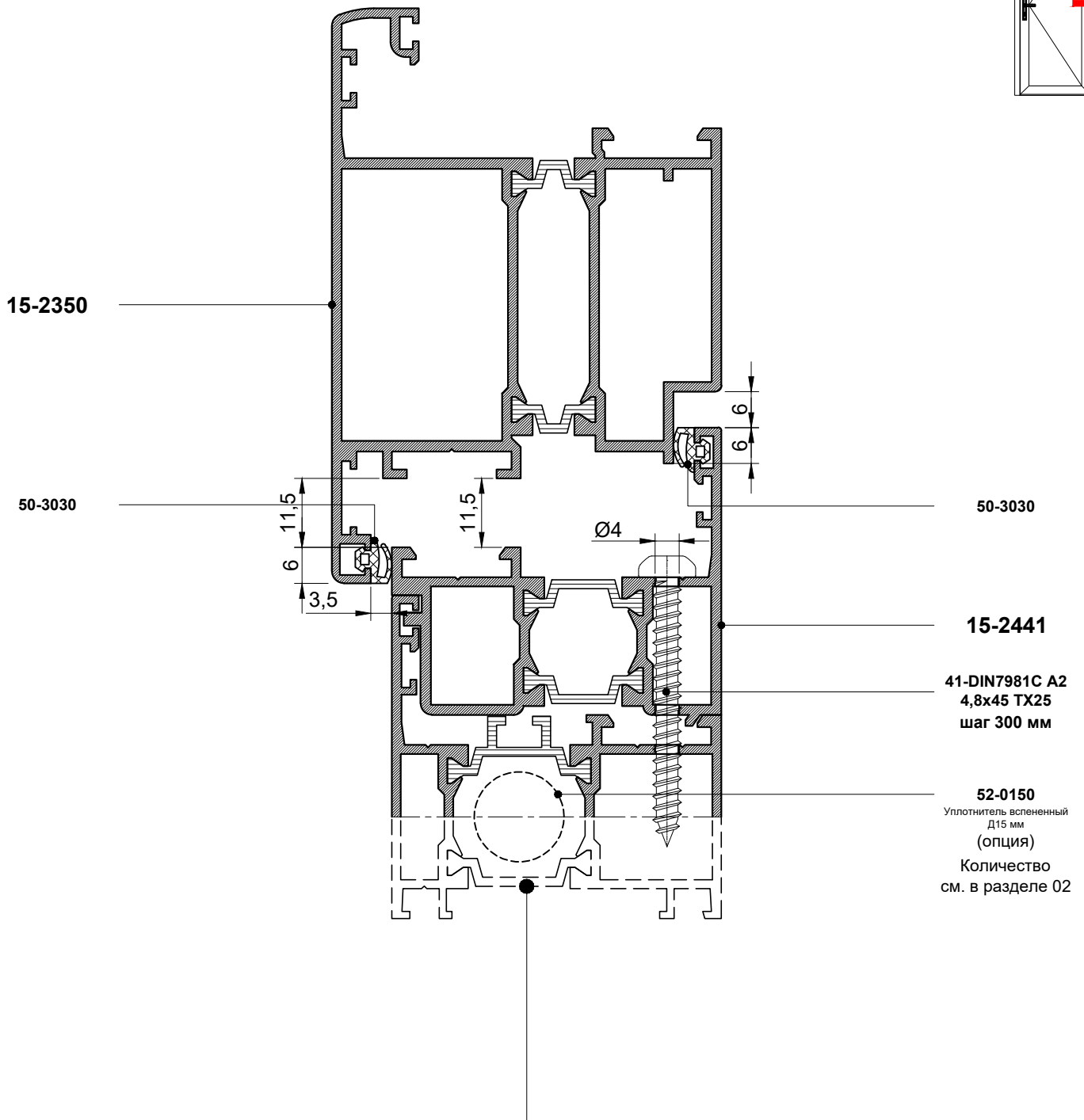
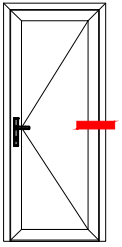

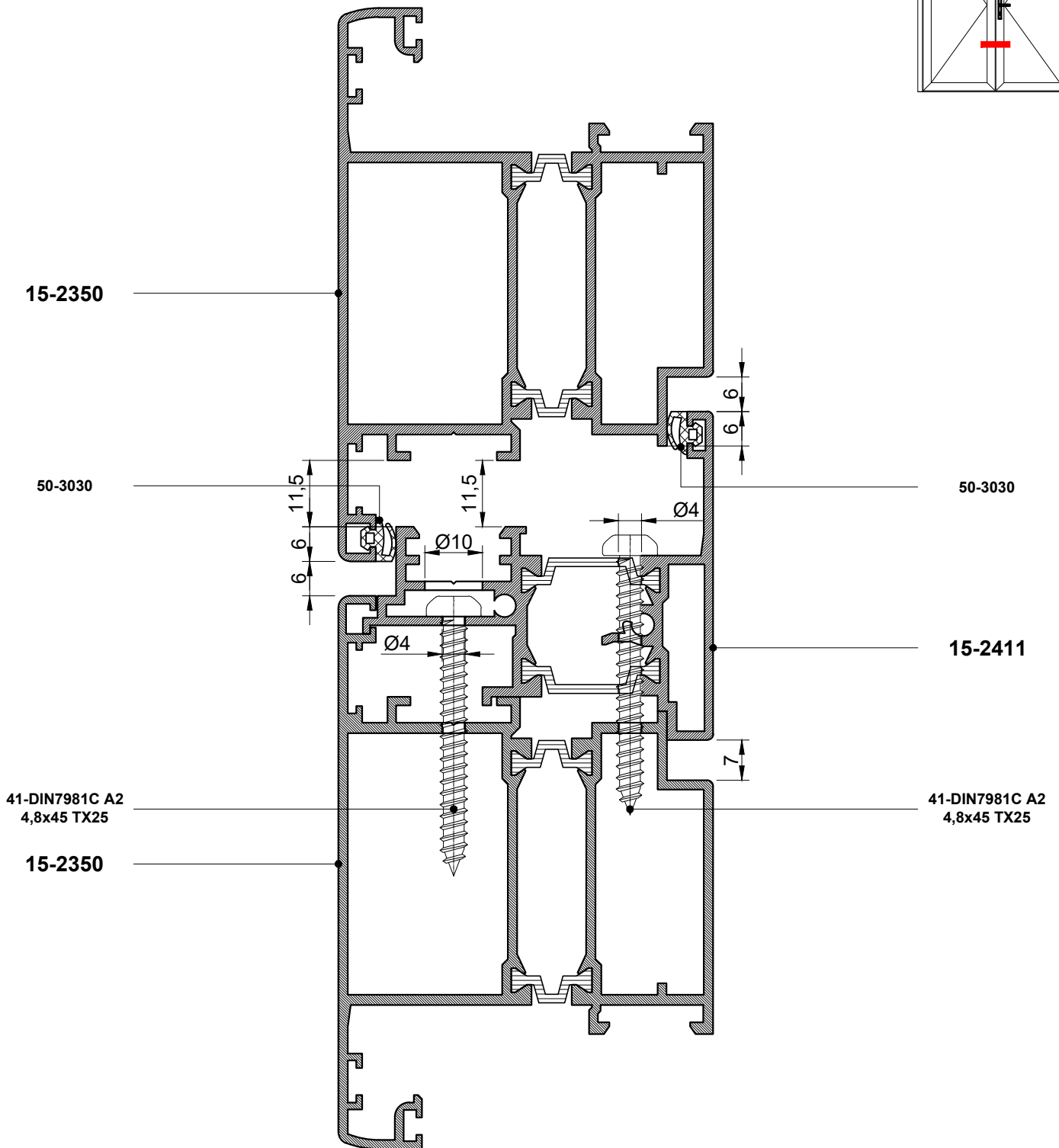
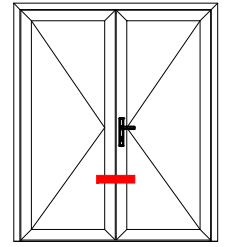

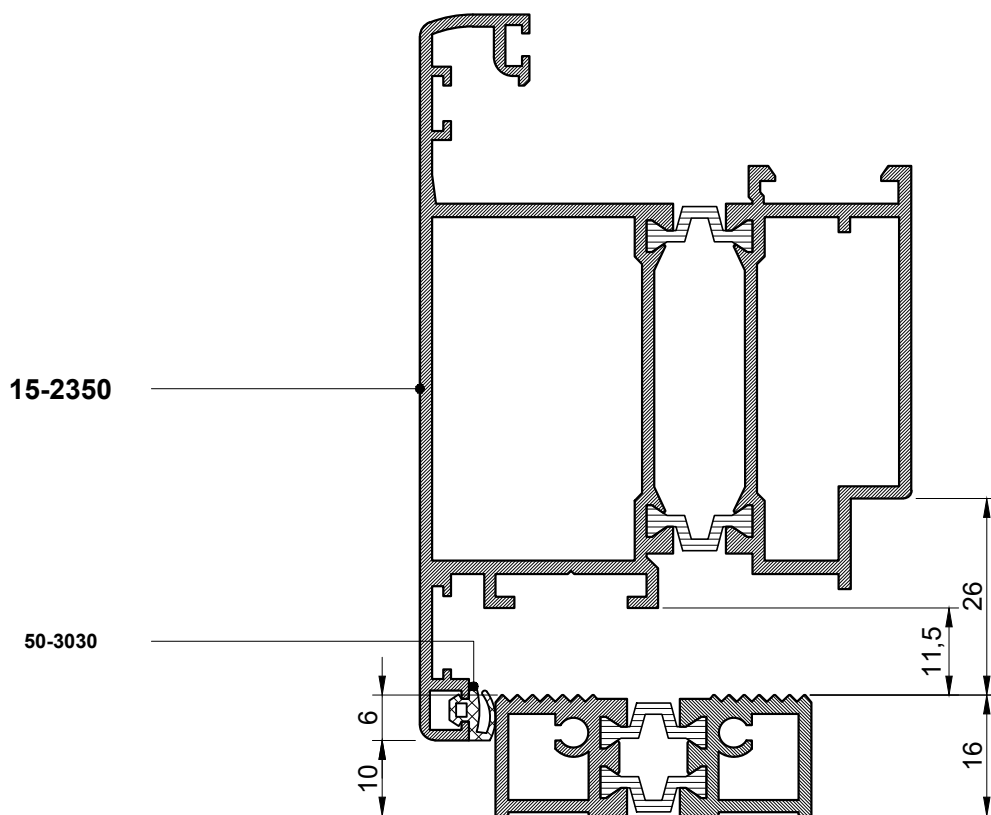
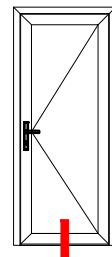

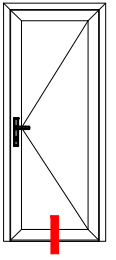

15-2350

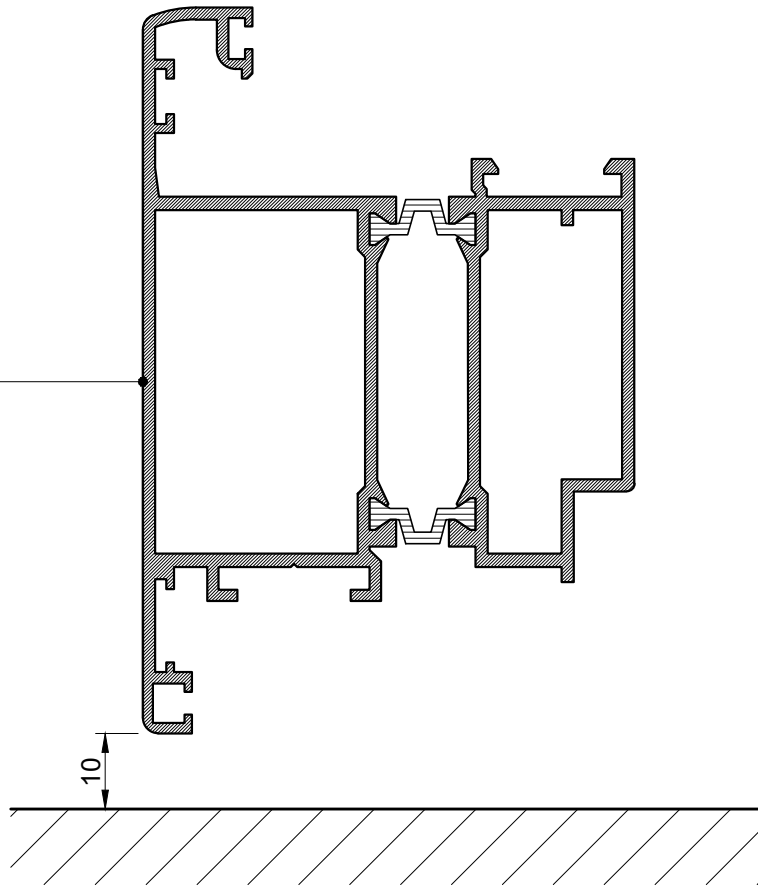

15-2141

15-2151

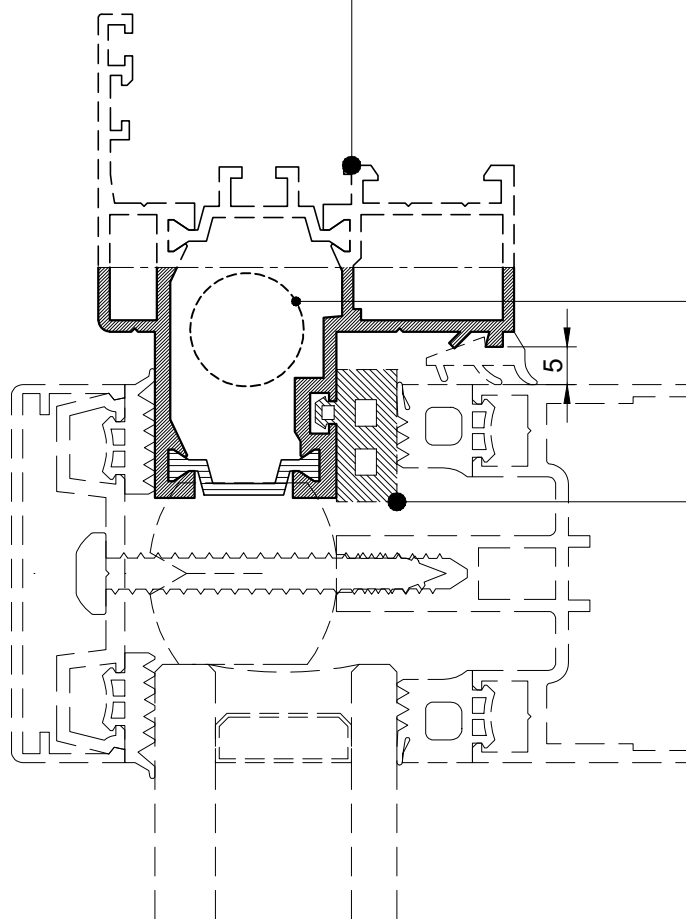
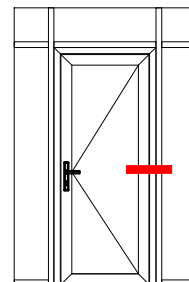
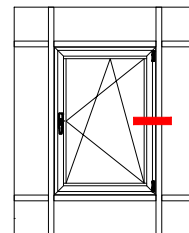
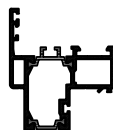
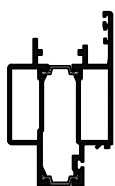

52-0150
Уплотнитель вспененный
Д15 мм
(опция)
Количество
см. в разделе 02

**смотри
каталог F50**



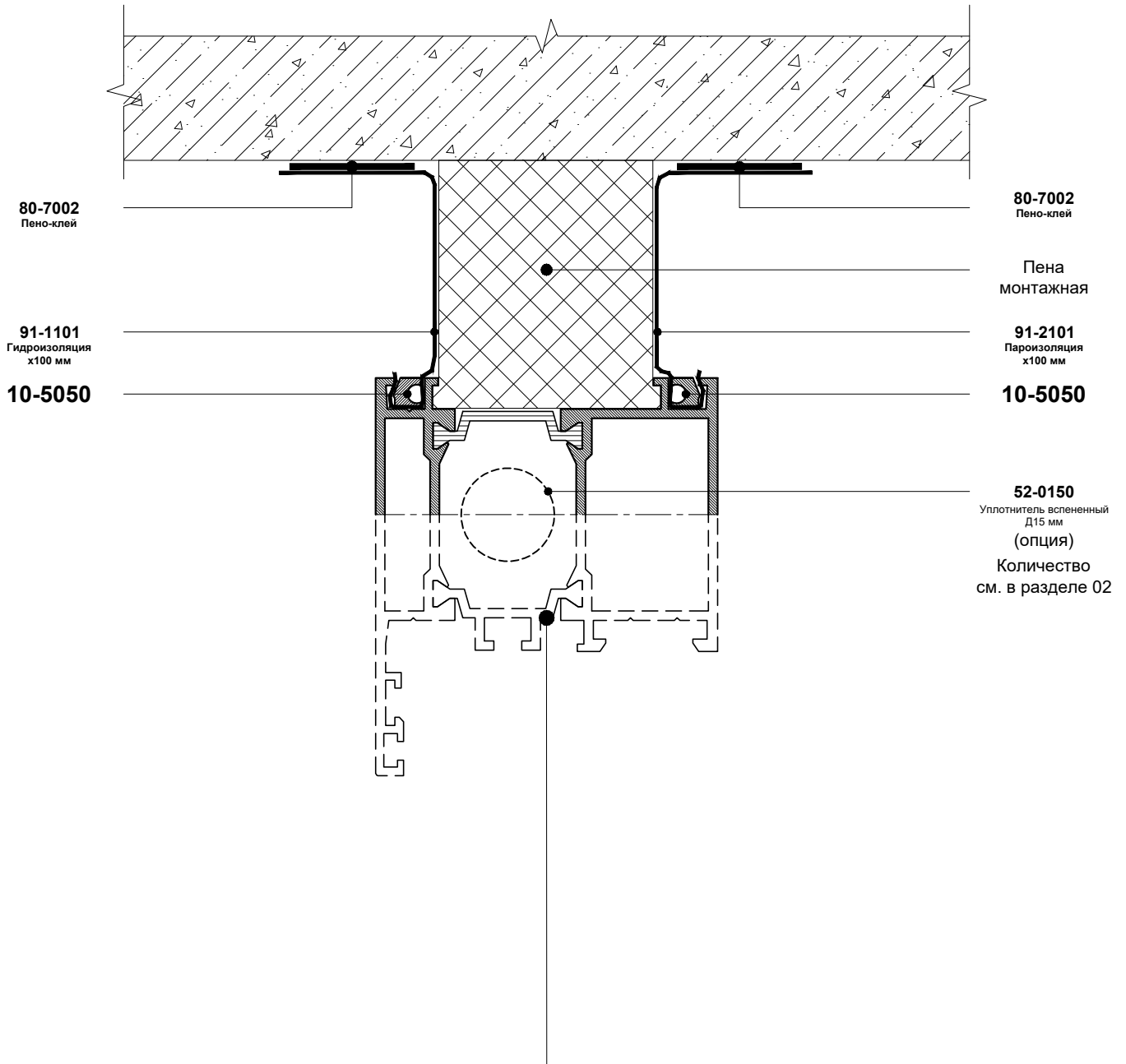
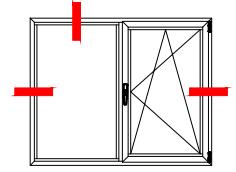

15-2110

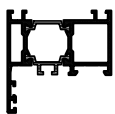

15-2112

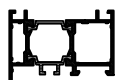

15-2111

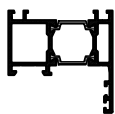

15-2121

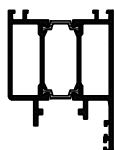

15-2130

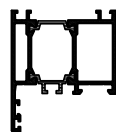

15-2131

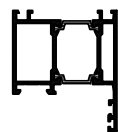

15-2110

15-2112

15-2111

15-2121

15-2130

15-2131

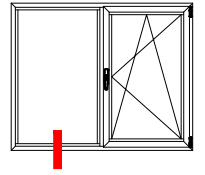
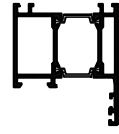
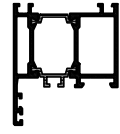
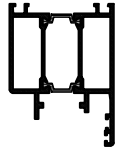
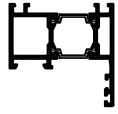
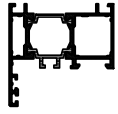
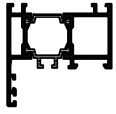

10-5050

91-1101
Гидроизоляция
x100 мм

80-7002
Пено-клей

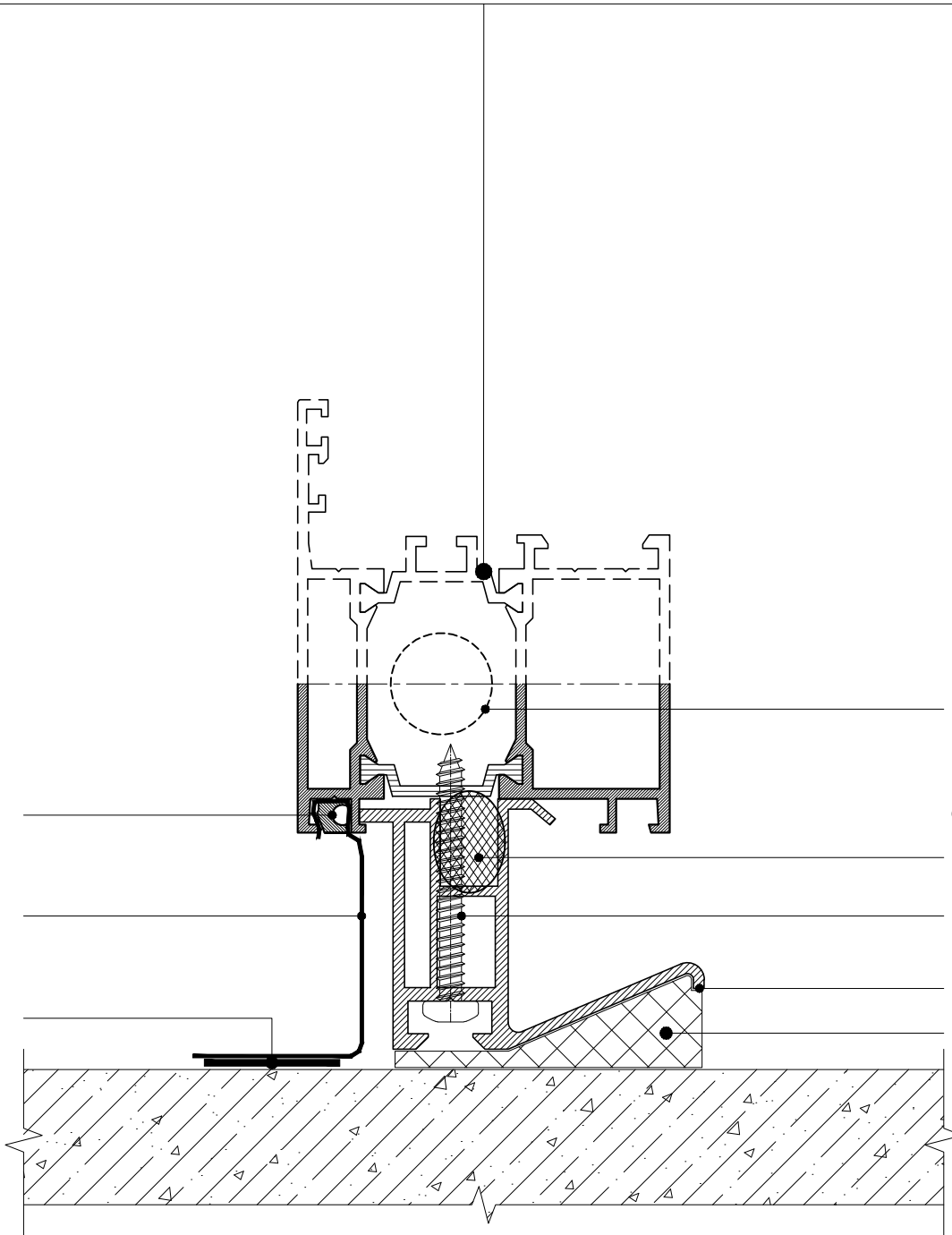

52-0150

Уплотнитель вспененный
Д15 мм
(опция)

Количество
см. в разделе 02

52-0150





















41-DIN7981C A2
4,2x38 TX20
шаг 300 мм

65-1003

Пена
монтажная



Таблица № 1

Профиль 2		Профиль 1																				
		15-2110	15-2112	15-2121	15-2130	15-2141	15-2151	15-2152	15-2170	15-2210	15-2212	15-2220	15-2221	15-2230	15-2240	15-2310	15-2312	15-2313	15-2320	15-2331	15-2341	15-2431
	15-2110	✓																				
	15-2112		✓																			
	15-2121			✓																		
	15-2130				✓																	
	15-2141					✓																
	15-2151						✓															
	15-2152							✓														
	15-2170								✓													
	15-2210									✓												
	15-2212										✓											
	15-2220											✓										
	15-2221												✓									
	15-2230													✓								
	15-2240														✓							
	15-2310															✓						
	15-2312																✓					
	15-2313																	✓				
	15-2320																		✓			
	15-2331																			✓	✓	
	15-2341																			✓	✓	
	15-2431																					✓











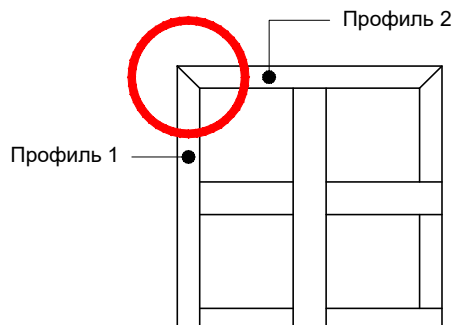

































Таблица № 2

Профиль 2 \ Профиль 1																						
		15-2110	15-2112	15-2121	15-2130	15-2141	15-2151	15-2152	15-2170	15-2210	15-2212	15-2220	15-2221	15-2230	15-2240	15-2310	15-2312	15-2313	15-2320	15-2331	15-2341	15-2431
	15-2110	✓	✓		✓					✓	✓	✓	✓		✓							
	15-2112	✓	✓							✓	✓	✓	✓		✓							
	15-2121							✓														
	15-2130	✓	✓		✓					✓	✓	✓	✓		✓							
	15-2141							✓														
	15-2151																					
	15-2152																					
	15-2170																					
	15-2210	✓	✓		✓					✓	✓	✓	✓		✓							
	15-2212	✓	✓		✓					✓	✓	✓	✓		✓							
	15-2220	✓	✓		✓					✓	✓	✓	✓		✓							
	15-2221	✓	✓		✓					✓	✓	✓	✓		✓							
	15-2230																					
	15-2240	✓	✓		✓					✓	✓	✓	✓		✓							
	15-2310																					
	15-2312																					
	15-2313																					
	15-2320																					
	15-2331	✓			✓			✓	✓						✓							
	15-2341	✓			✓			✓	✓						✓							
	15-2431							✓														











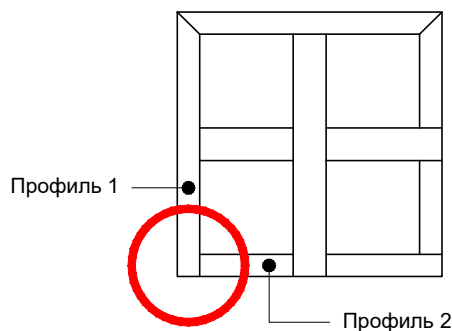

































Таблица № 3

Профиль 2 \ Профиль 1																						
		15-2110	15-2112	15-2121	15-2130	15-2141	15-2151	15-2152	15-2170	15-2210	15-2212	15-2220	15-2221	15-2230	15-2240	15-2310	15-2312	15-2313	15-2320	15-2331	15-2341	15-2431
	15-2110																					
	15-2112																					
	15-2121																					
	15-2130																					
	15-2141																					
	15-2151																					
	15-2152																					
	15-2170																					
	15-2210	✓	✓		✓					✓	✓	✓	✓		✓							
	15-2212	✓	✓		✓					✓	✓	✓	✓		✓							
	15-2220	✓	✓		✓					✓	✓	✓	✓		✓							
	15-2221	✓	✓		✓					✓	✓	✓	✓		✓							
	15-2230																					
	15-2240	✓	✓		✓					✓	✓	✓	✓		✓							
	15-2310																					
	15-2312																					
	15-2313																					
	15-2320																					
	15-2331																					
	15-2341																					
	15-2431																					











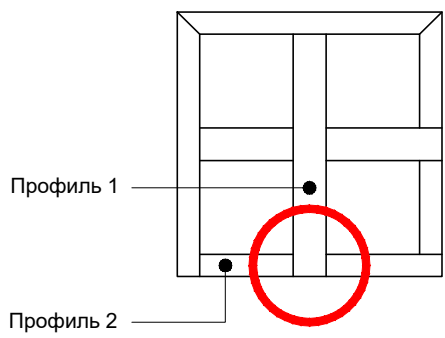

































Таблица № 4

Профиль 2 \ Профиль 1																						
		15-2110	15-2112	15-2121	15-2130	15-2141	15-2151	15-2152	15-2170	15-2210	15-2212	15-2220	15-2221	15-2230	15-2240	15-2310	15-2312	15-2313	15-2320	15-2331	15-2341	15-2431
	15-2110									✓	✓	✓	✓		✓							
	15-2112									✓	✓	✓	✓		✓							
	15-2121																					
	15-2130									✓	✓	✓	✓		✓							
	15-2141																					
	15-2151									✓	✓				✓							
	15-2152									✓	✓				✓							
	15-2170																					
	15-2210									✓	✓	✓	✓		✓							
	15-2212									✓	✓	✓	✓		✓							
	15-2220									✓	✓	✓	✓		✓							
	15-2221									✓	✓	✓	✓		✓							
	15-2230																					
	15-2240									✓	✓	✓	✓		✓							
	15-2310														✓							
	15-2312																					
	15-2313																					
	15-2320														✓							
	15-2331									✓					✓							
	15-2341									✓					✓							
	15-2431																					











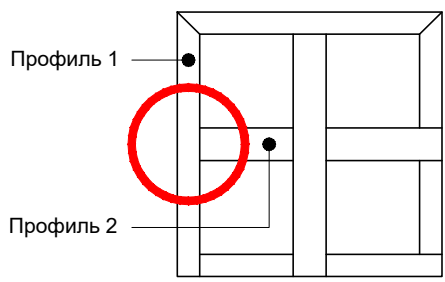

































Таблица № 5

Профиль 2 \ Профиль 1																						
		15-2110	15-2112	15-2121	15-2130	15-2141	15-2151	15-2152	15-2170	15-2210	15-2212	15-2220	15-2221	15-2230	15-2240	15-2310	15-2312	15-2313	15-2320	15-2331	15-2341	15-2431
	15-2110																					
	15-2112																					
	15-2121																					
	15-2130																					
	15-2141																					
	15-2151																					
	15-2152																					
	15-2170																					
	15-2210									✓	✓				✓							
	15-2212									✓	✓				✓							
	15-2220									✓	✓	✓			✓							
	15-2221									✓	✓		✓		✓							
	15-2230													✓								
	15-2240									✓	✓				✓							
	15-2310																					
	15-2312																					
	15-2313																					
	15-2320																					
	15-2331																					
	15-2341																					
	15-2431																					



15-2110 15-2112 15-2130 15-2210 15-2212 15-2220 15-2240

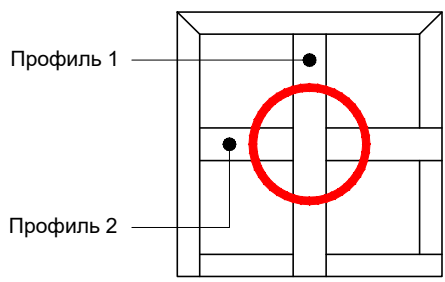
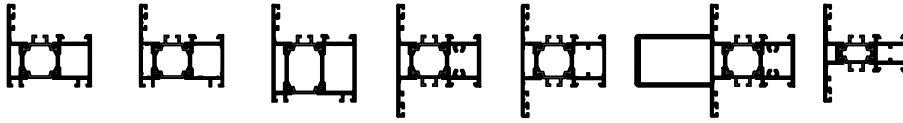

См. таблицы 2-5, стр. 06.002, 06.003, 06.004, 06.005

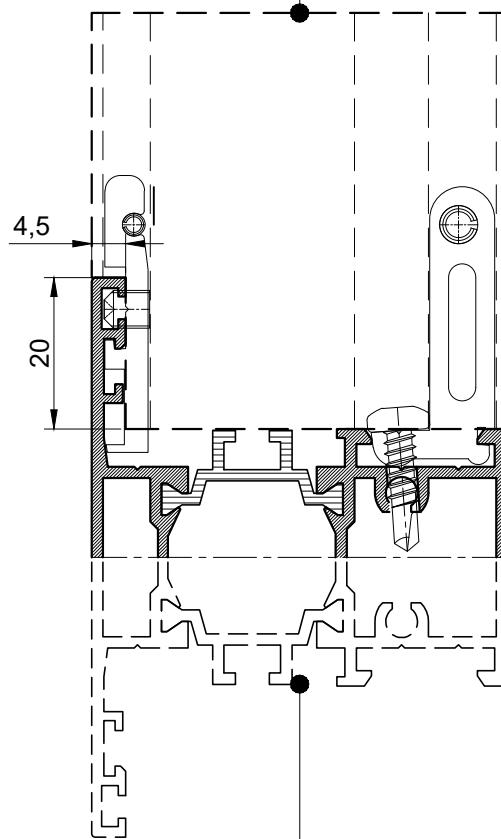

15-2110 15-2112 15-2130 15-2151 15-2152 15-2210 15-2212 15-2220 15-2240 15-2331 15-2341

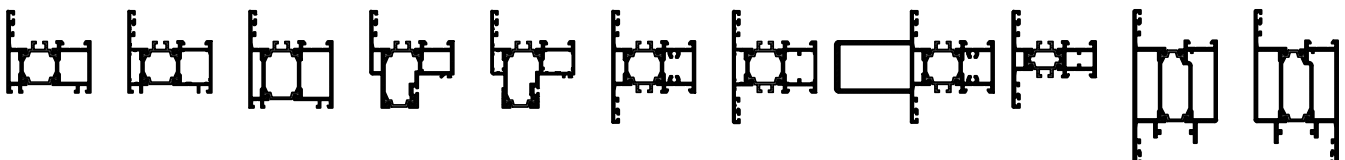

15-2230

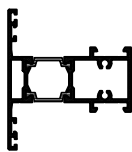

См. таблицы 2-5, стр. 06.002, 06.003, 06.004, 06.005

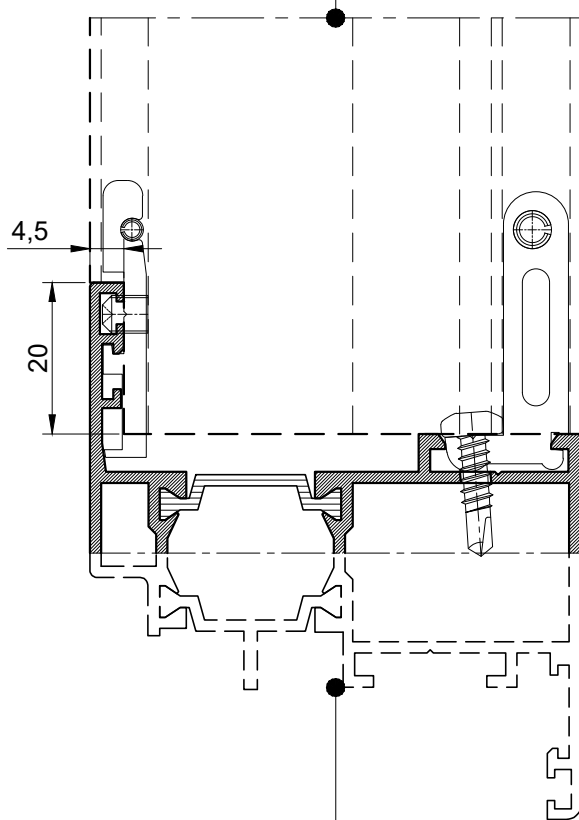

15-2230

15-2310

15-2313

15-2320

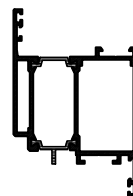
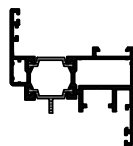
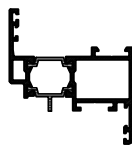
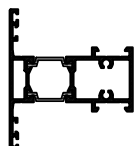

15-2210

15-2240

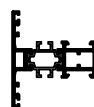
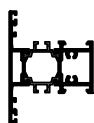

См. таблицы 2-5, стр. 06.002, 06.003, 06.004, 06.005

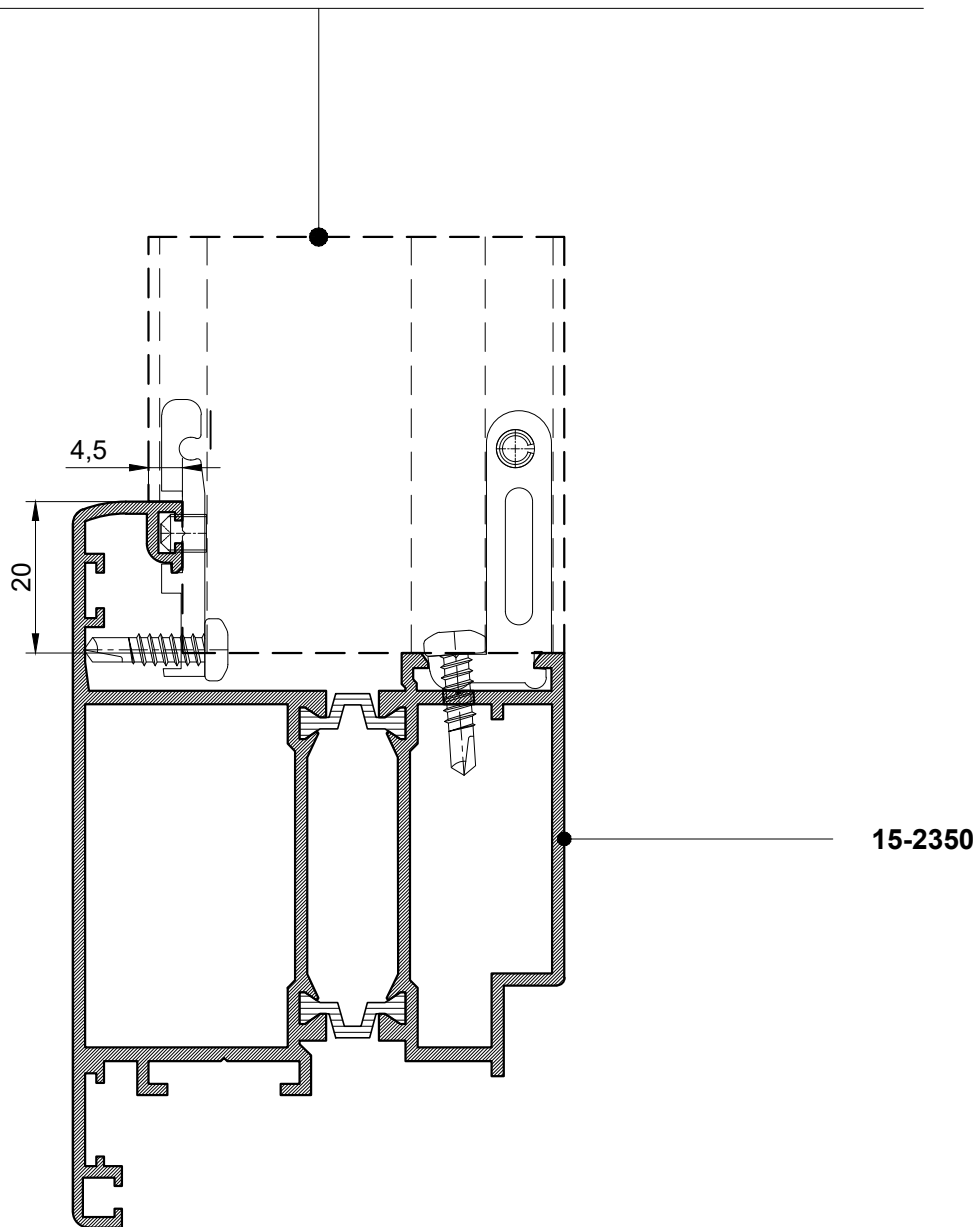

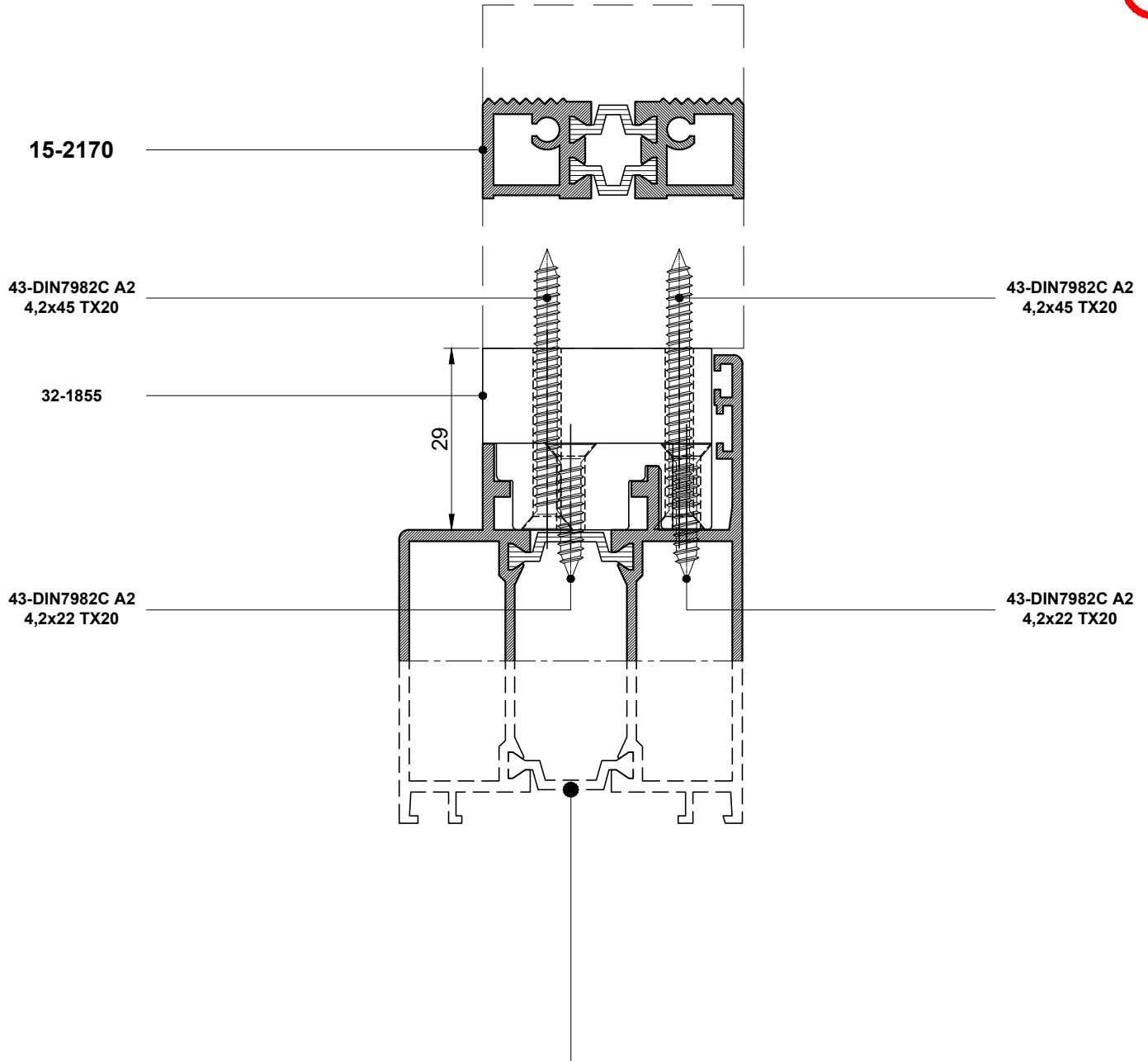
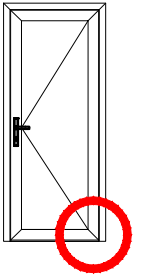

15-2121

15-2141

15-2341

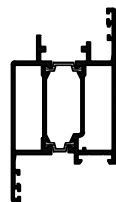
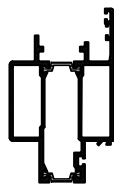
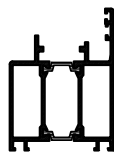

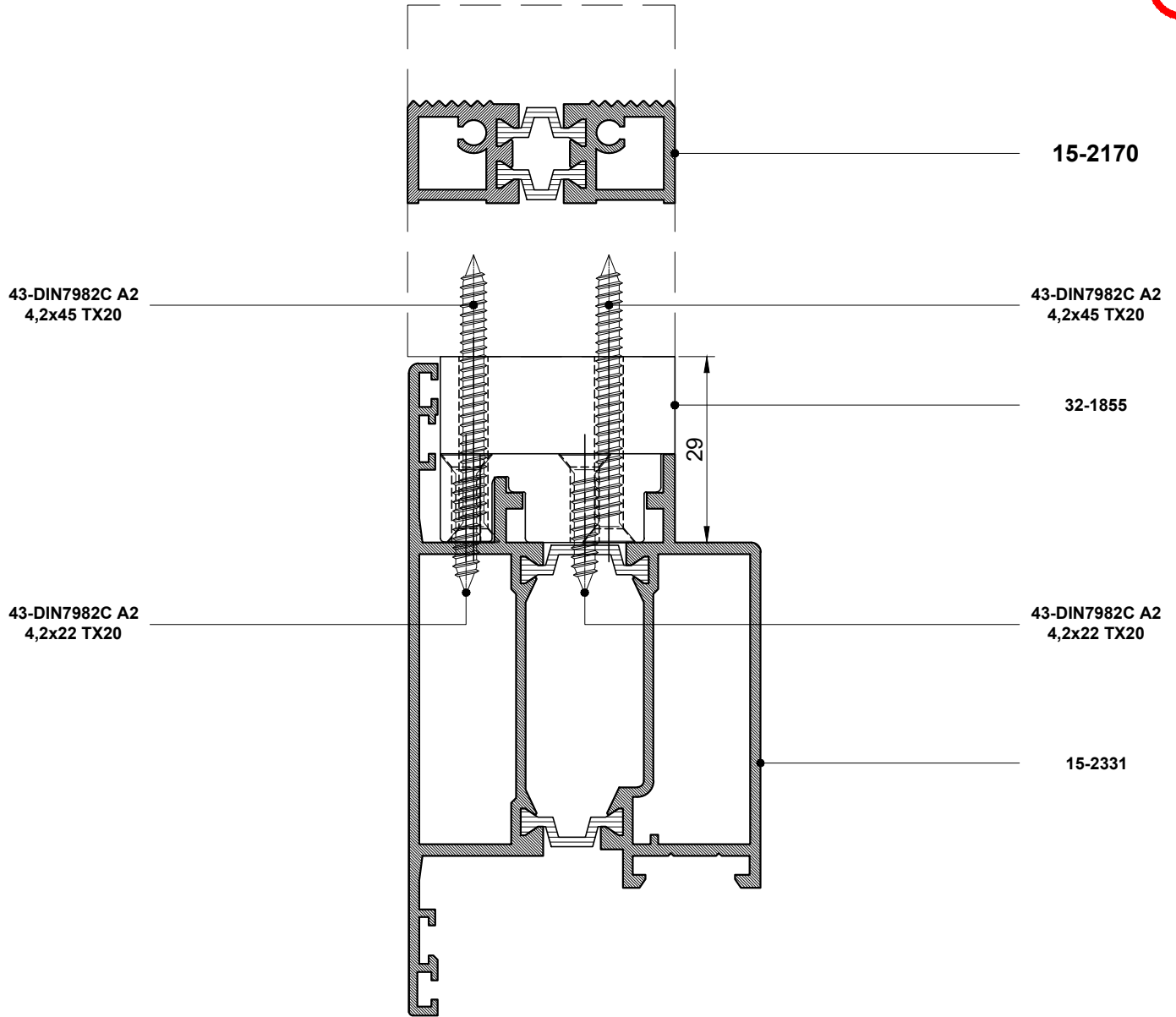
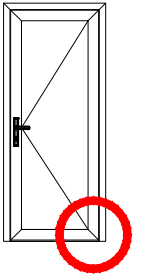

15-2110

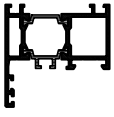

15-2130

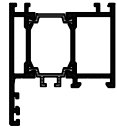

15-2151

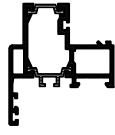

15-2210

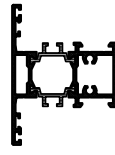

15-2220

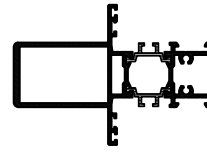

15-2240

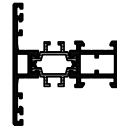

33-2055
Комплект заглушек
штульпа WD55

15-2412

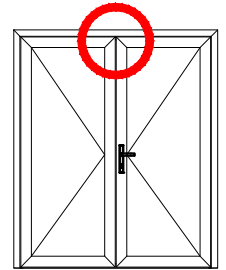
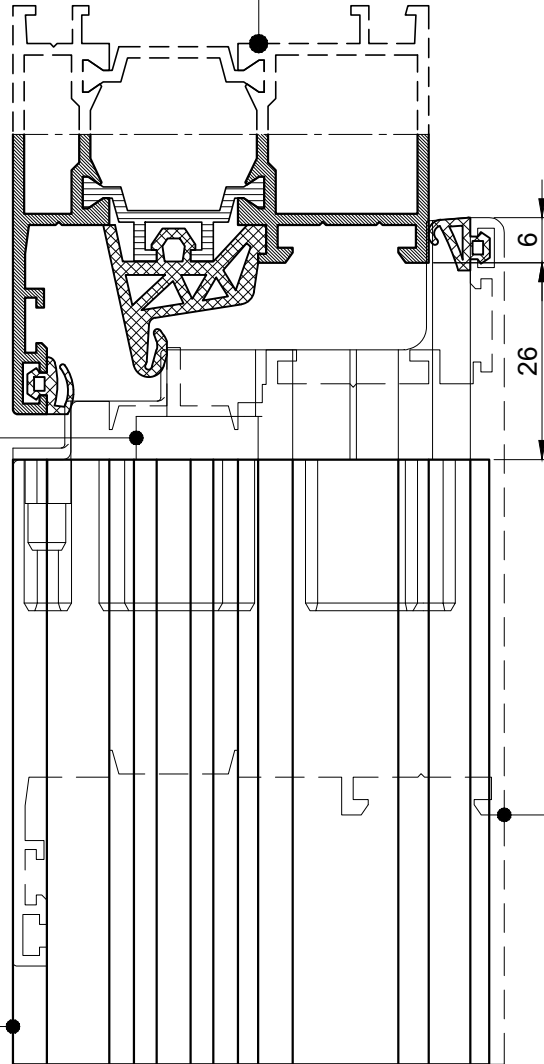

15-2310

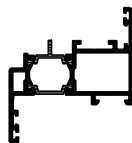

15-2320

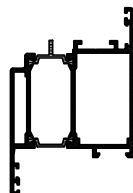

15-2111

15-2131

15-2441

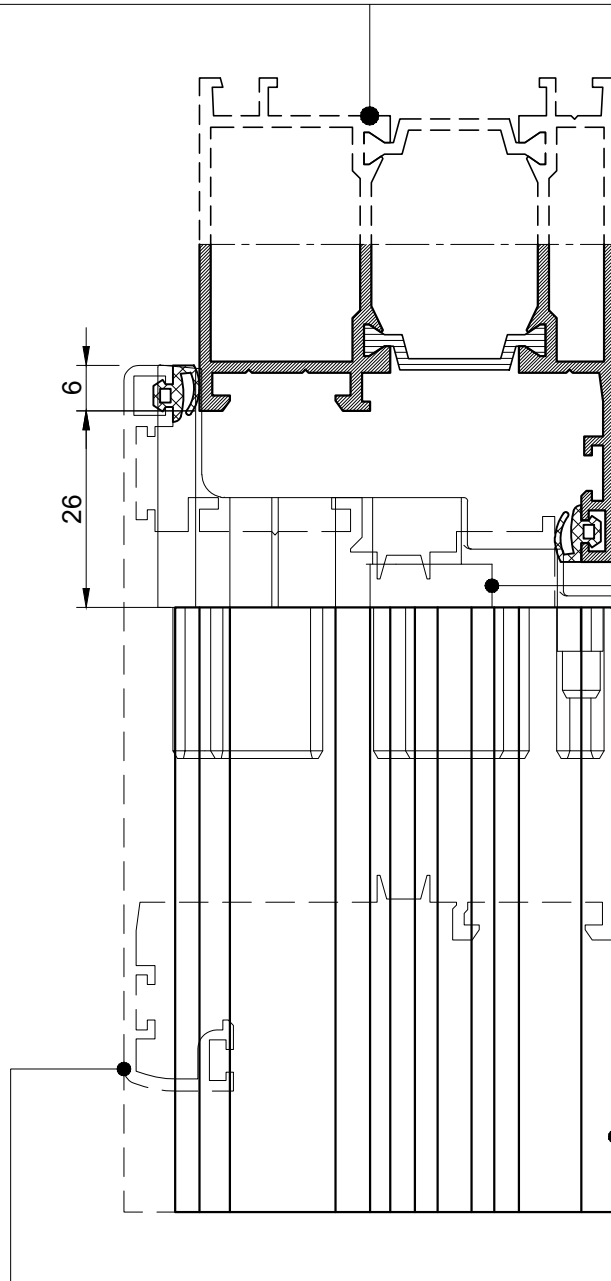
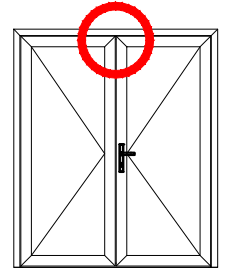
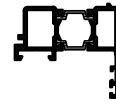
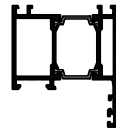
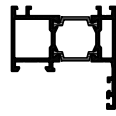

33-2055
Комплект заглушек
штульпа WD55

15-2411

15-2350

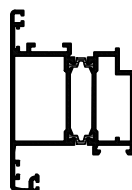

15-2350

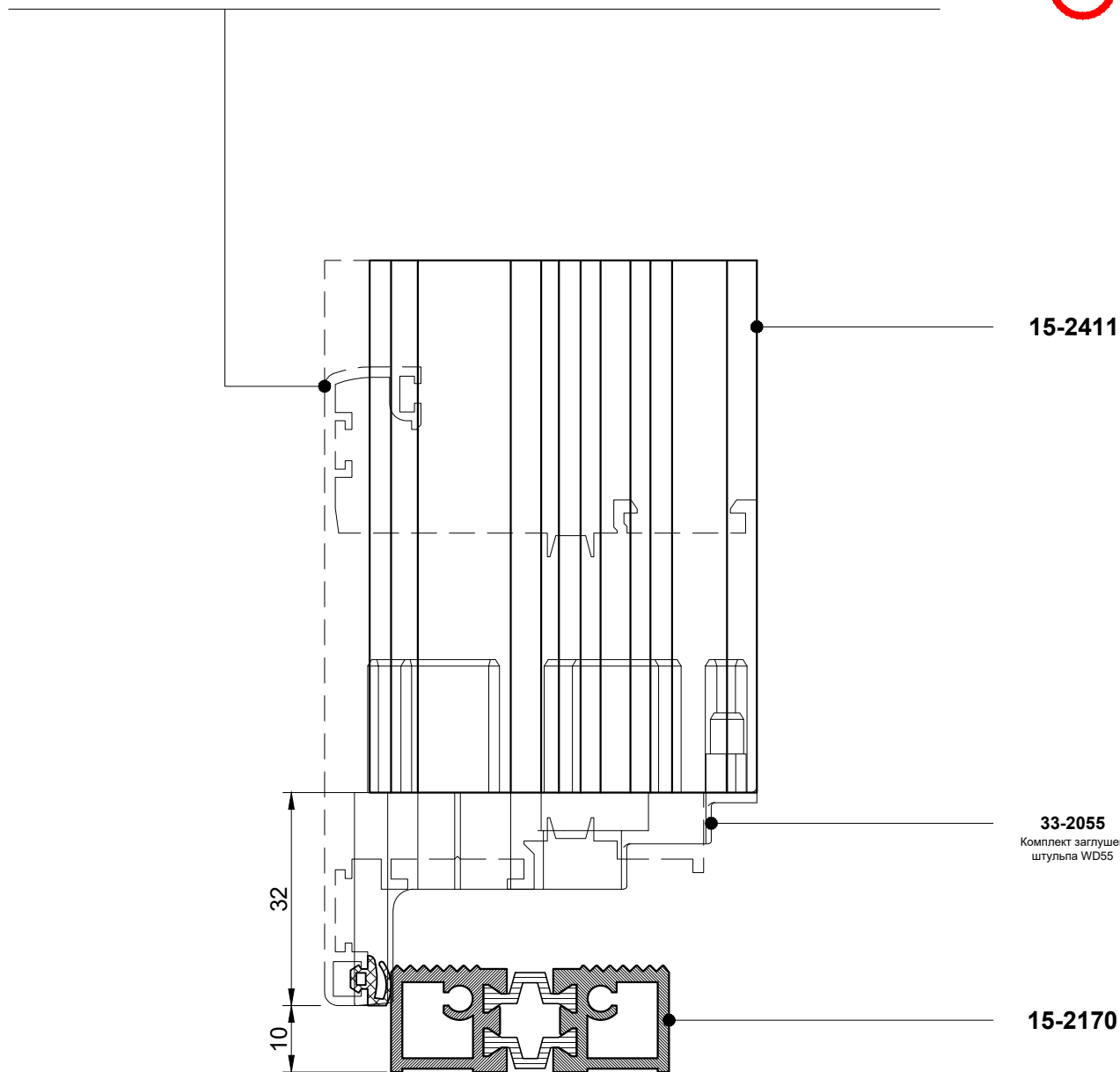
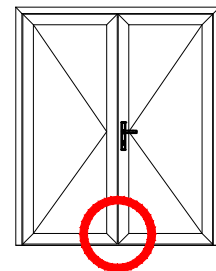
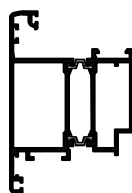

15-2350

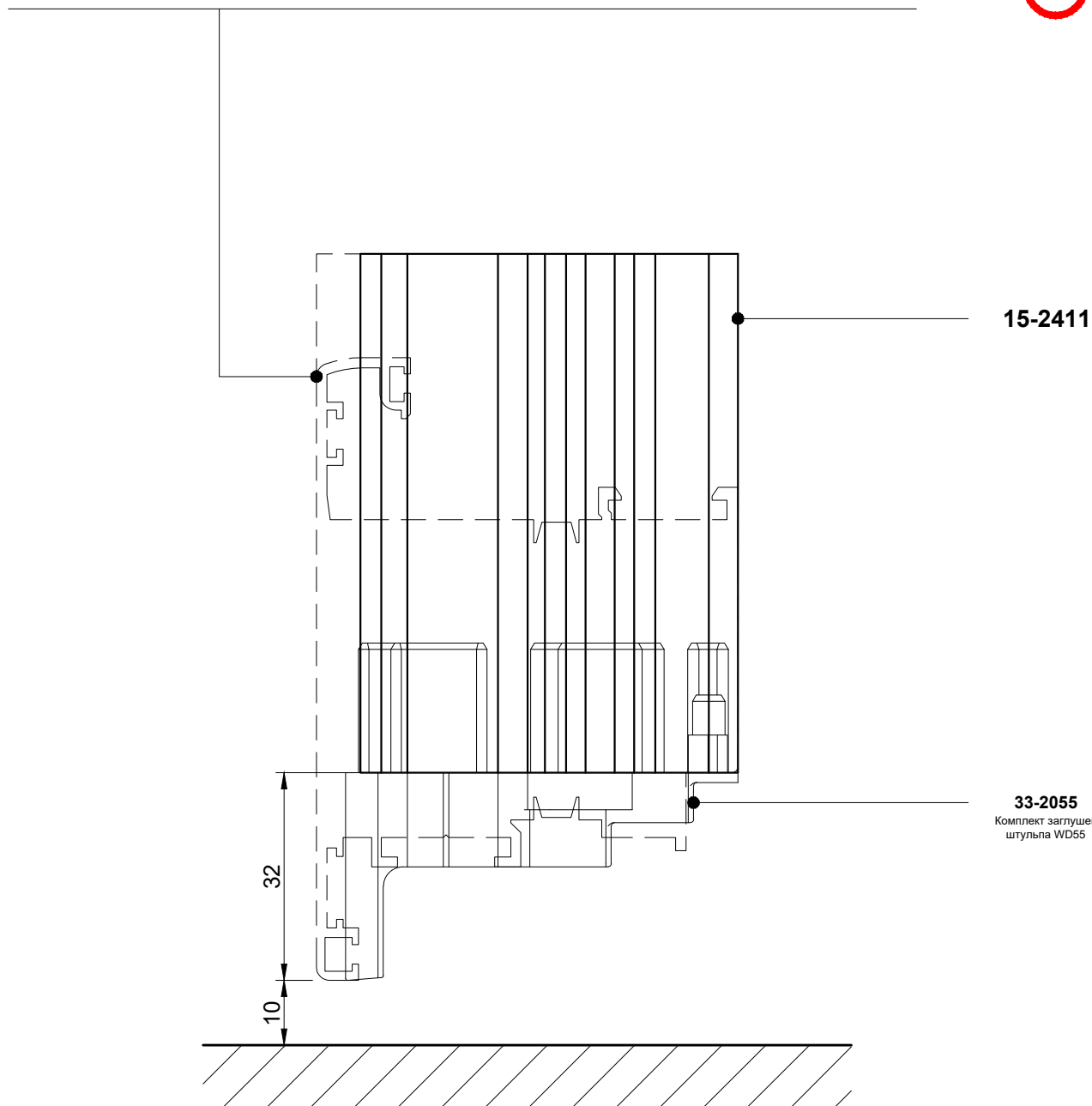
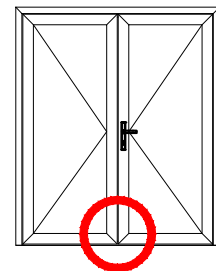
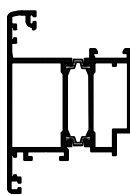

Толщина заполнения, А мм	Профили 55 мм		Профили 65 мм		Уплотнитель	
	Артикул	X1, мм	Артикул	X2, мм	Артикул	S, мм
	6	10-6320	32,5	10-6420	42,5	50-1290
8	50-1270					7
10	50-1250					5
12	10-6260	26,5	10-6360	36,5	50-1290	9
14					50-1270	7
16					50-1250	5
18	10-6220	22,5	10-6320	32,5	50-1270	7
20					50-1250	5
22					50-1290	9
24	10-6160	16,5	10-6260	26,5	50-1270	7
26					50-1250	5
28					50-1270	7
30	10-6120	12,5	10-6220	22,5	50-1250	5
32					50-1290	9
34					50-1270	7
36	10-6060	6,5	10-6160	16,5	50-1250	5
					50-1290	9

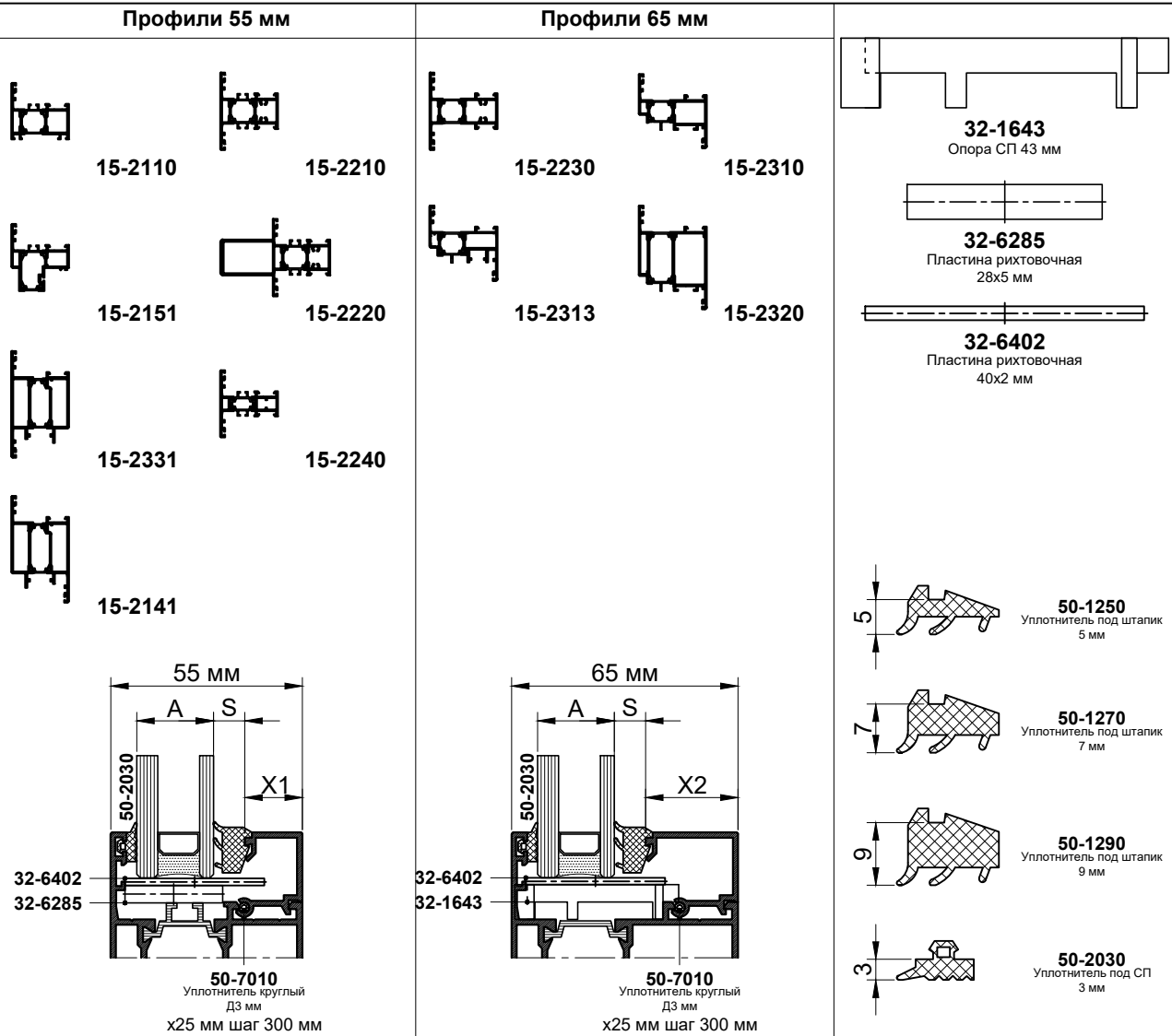

Толщина заполнения, А мм	Профили 65 мм		Уплотнитель	
	Артикул	X1, мм	Артикул	S, мм
6	10-6320	32,5	50-1290	9
8			50-1270	7
10			50-1250	5
12	10-6260	26,5	50-1290	9
14			50-1270	7
16			50-1250	5
18	10-6220	22,5	50-1270	7
20			50-1250	5
22			50-1290	9
24	10-6160	16,5	50-1270	7
26			50-1250	5
28			50-1270	7
30	10-6120	12,5	50-1250	5
32			50-1290	9
34			50-1270	7
36	10-6060	6,5	50-1250	5

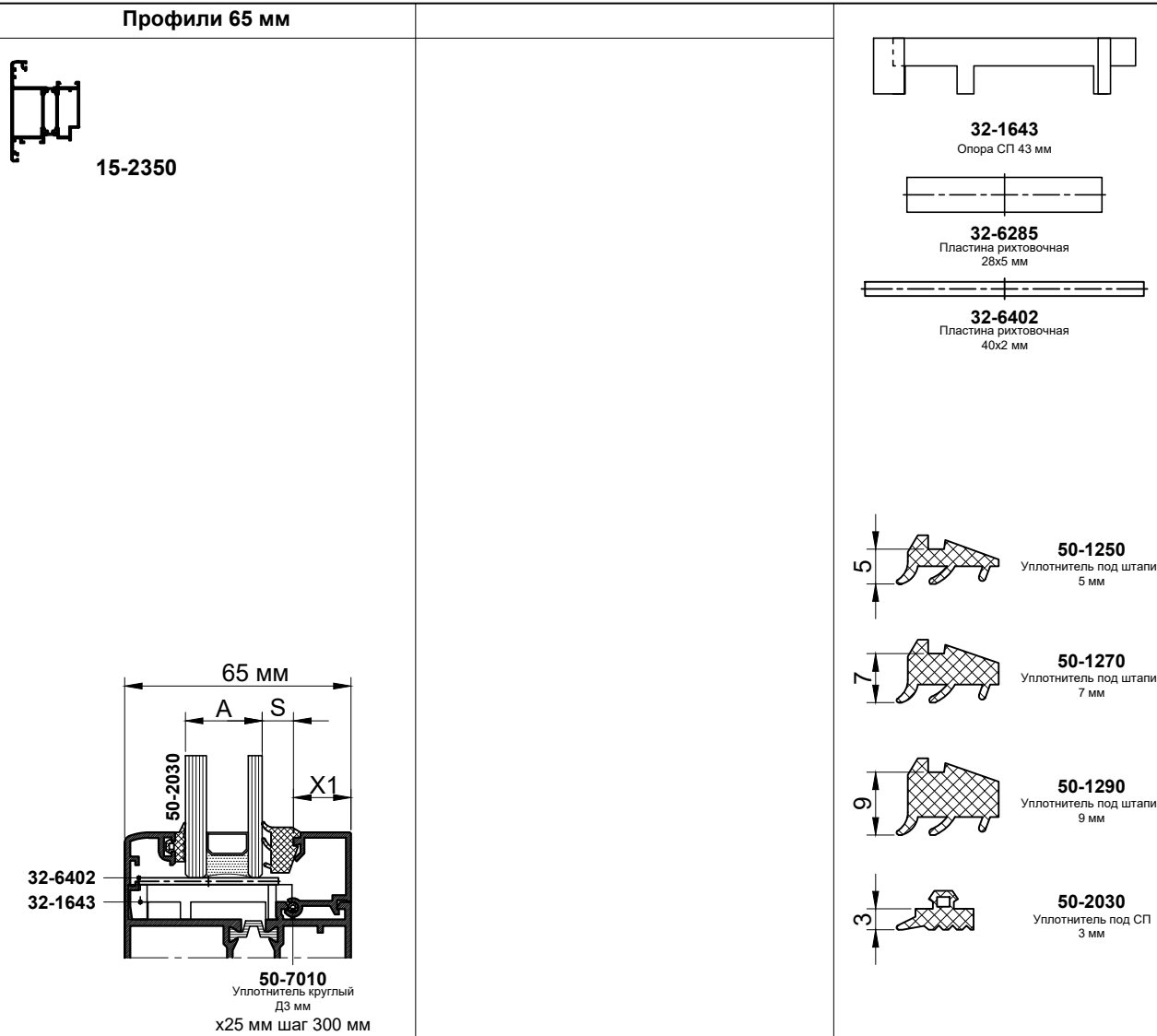

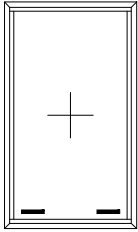
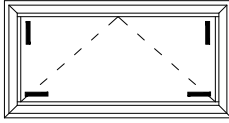
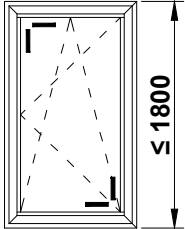
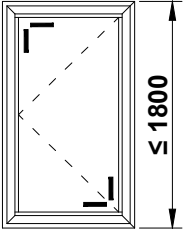
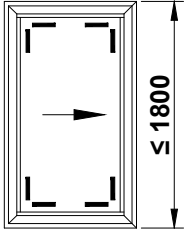
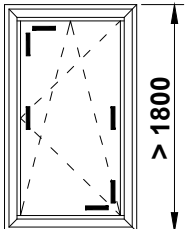
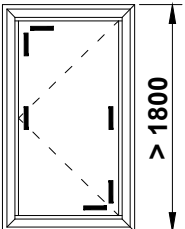
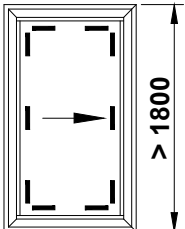
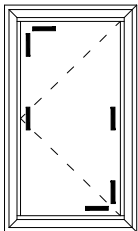
№ Комплекта	Схема изделия	Артикул	№ Комплекта	Схема изделия	Артикул
1		15-2110 15-2130 15-2210 15-2220 15-2240	2		15-2310 15-2313 15-2320
3	 	15-2310 15-2313 15-2320	4		15-2310 15-2313 15-2320
5	 	15-2310 15-2313 15-2320	6		15-2310 15-2313 15-2320
7		15-2331 15-2341 15-2350			

№ Комплекта	Опора стеклопакета	Пластина рихтовочная			
	32-1643 Опора СП 43 мм	32-6285 Пластина рихтовочная 28x5 мм	32-6401 Пластина рихтовочная 40x1 мм	32-6402 Пластина рихтовочная 40x2 мм	32-6403 Пластина рихтовочная 40x3 мм
1		x1	x2		x2
2	x4	x1	x4	x1	
3	x4	x1	x4	x1	
4	x8	x2	x8	x2	
5	x6	x2	x6	x2	
6	x10	x3	x10	x2	
7		x2	x6	x2	x6



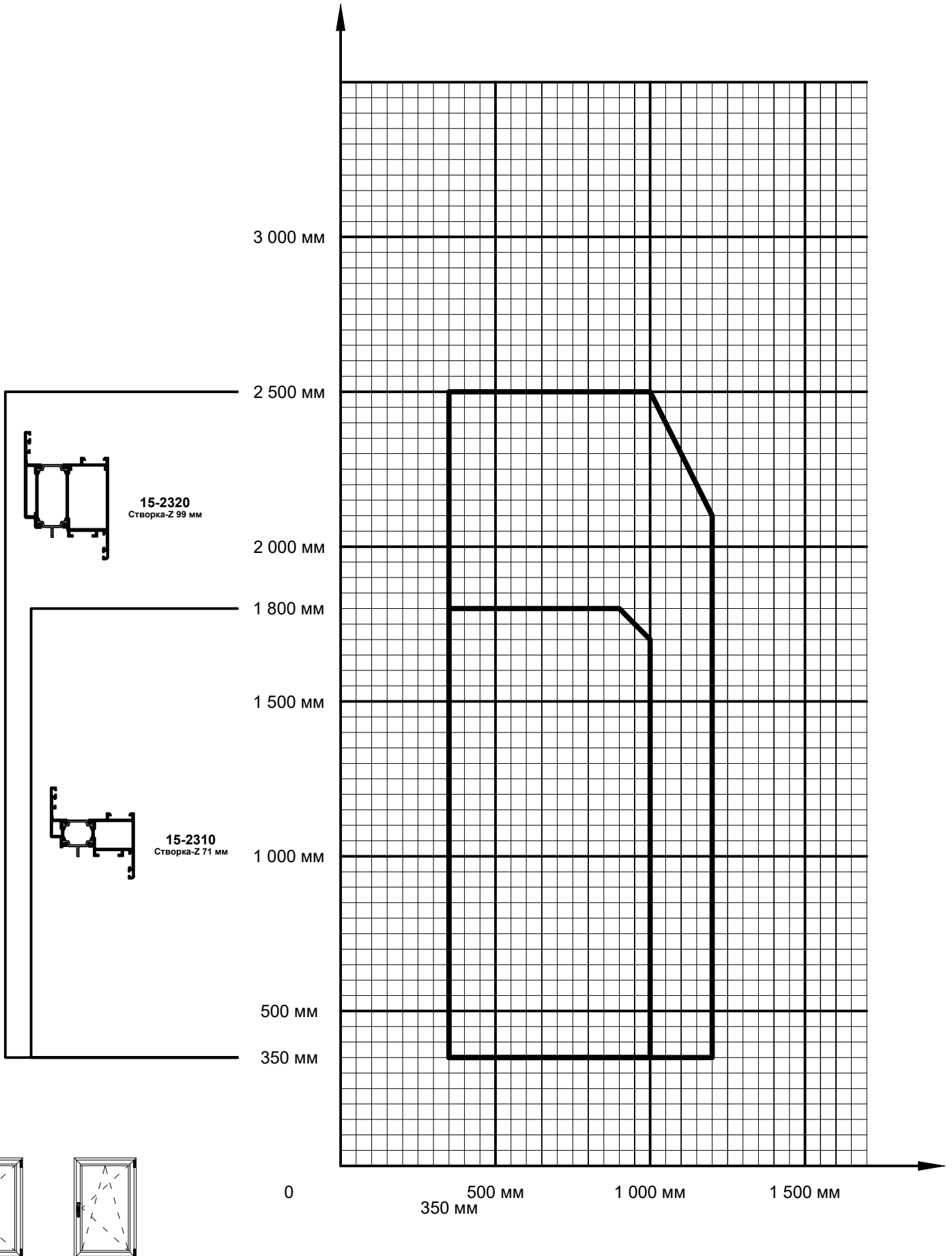

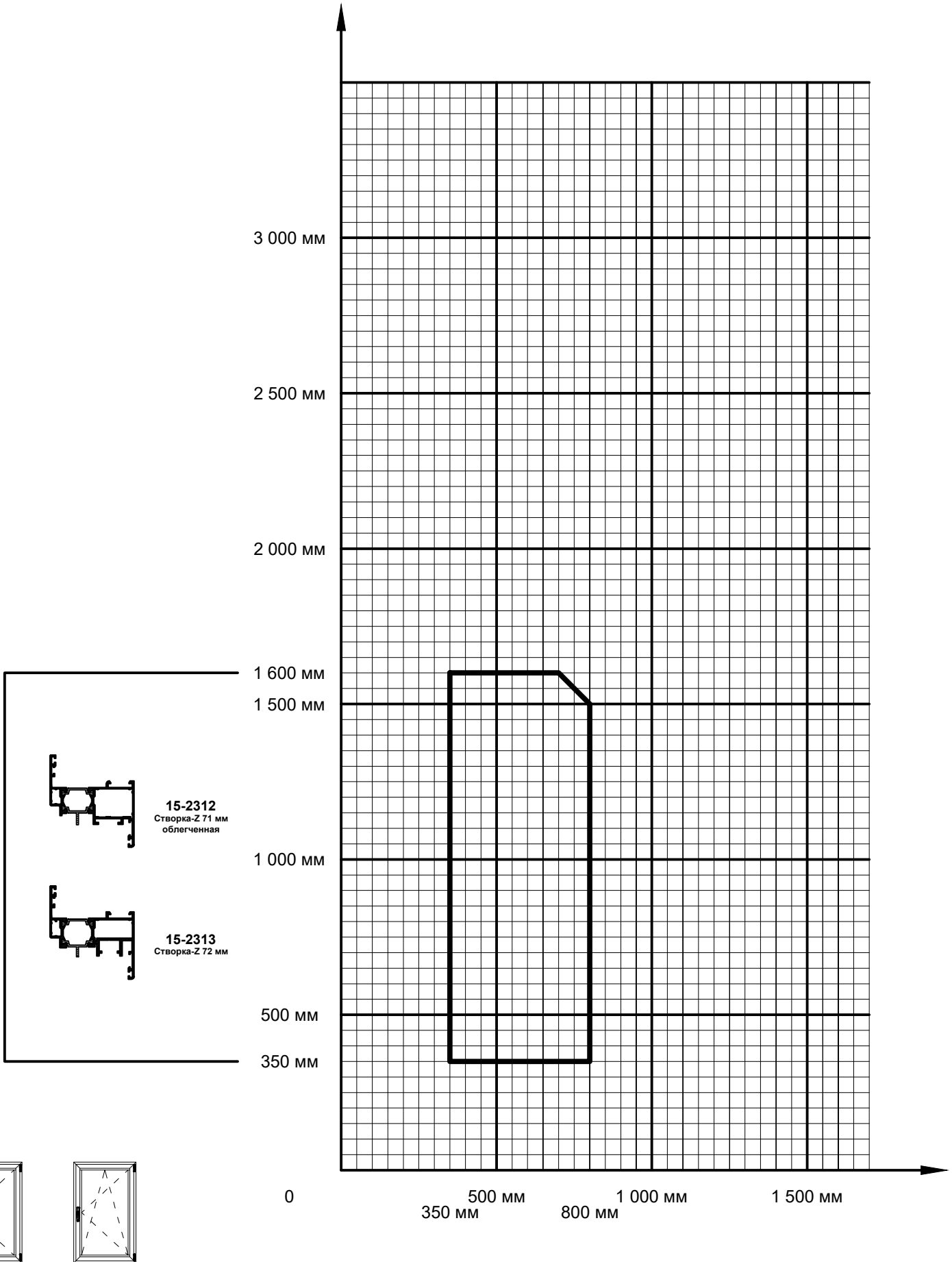

$h \leq 1200$

$1200 < h \leq 2400$

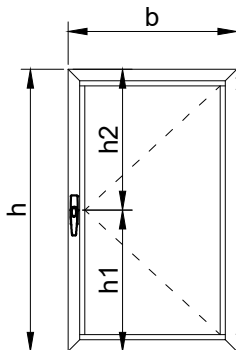
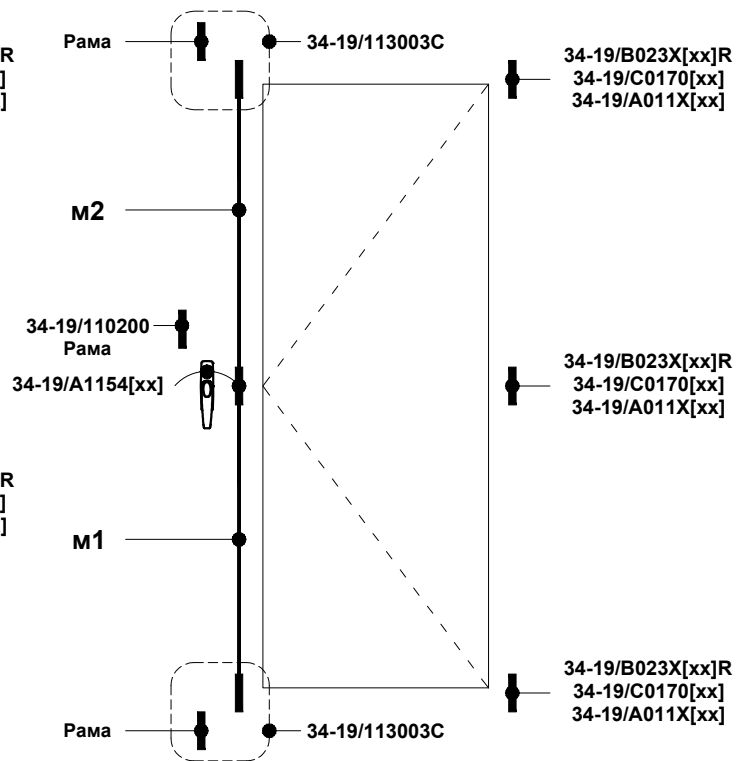
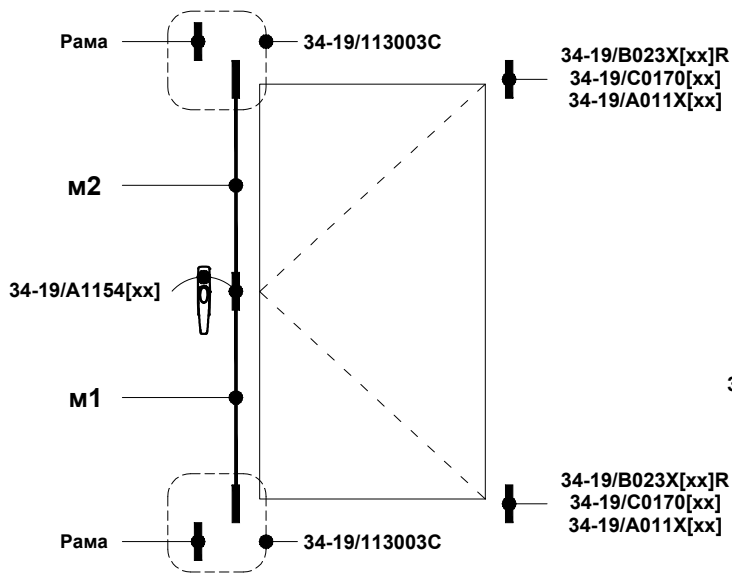

15-2310 15-2312 15-2320



Мувиль	Длина, мм
м1	h1 - 82
м2	h2 - 190

Вес створки, кг	Навес	Ручка	Запорная часть		Ограничения	
			$h \leq 1200$	$1200 < h \leq 2400$	Ширина	Высота
≤ 50	34-19/B023X[xx]R	34-19/A1154[xx]	34-19/113003C x2	34-19/113003C x2 34-19/110200	см. диаграмму	
≤ 60	34-19/C0170[xx]					
≤ 90	34-19/A011X[xx]					



$h \leq 1200$

$1200 < h \leq 2400$

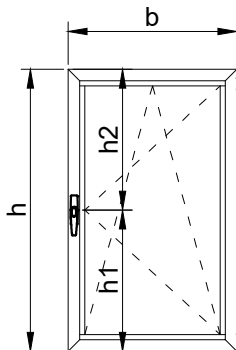
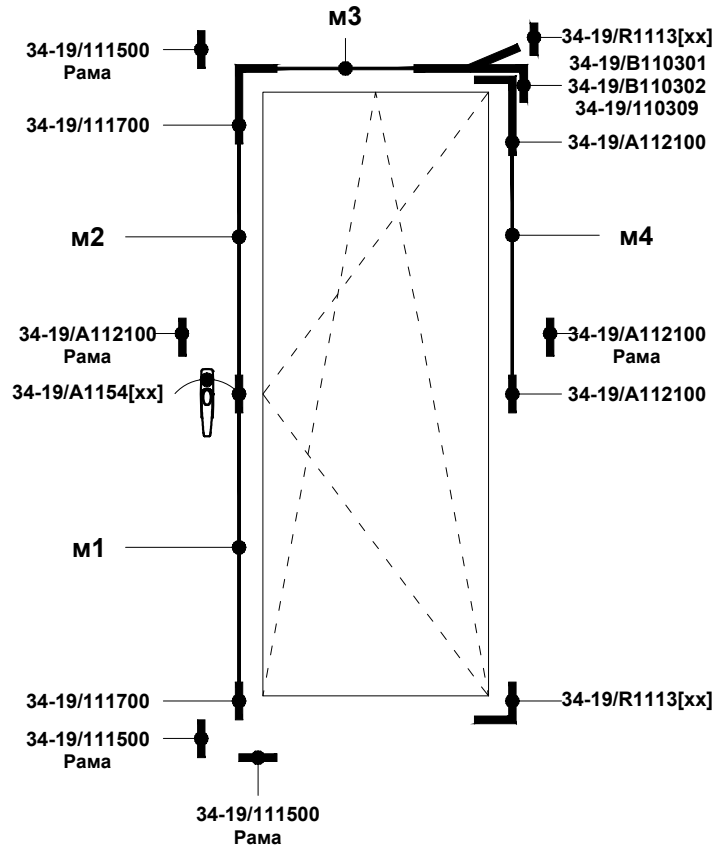
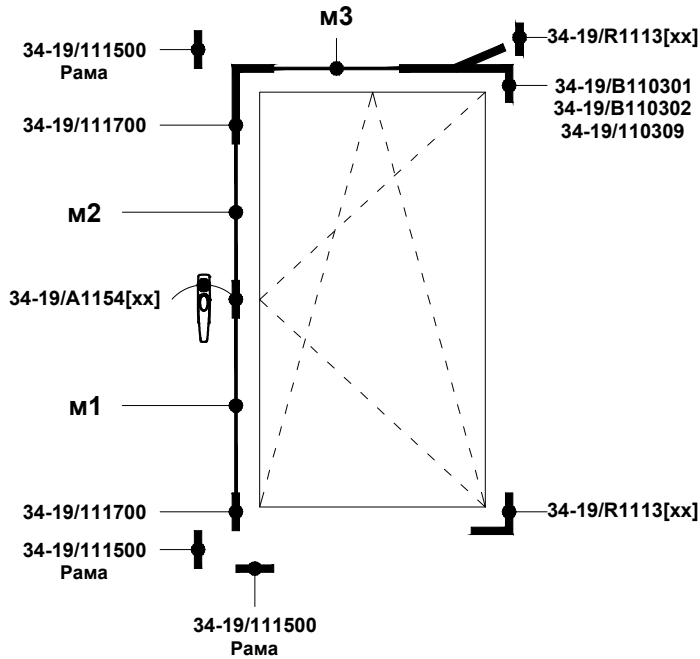

15-2310 15-2312 15-2320



Мувиљ	Артикул	Длина, мм
м1		h1 - 82
м2		h2 - 190
м3	34-19/B110301	b - 495
	34-19/B110302	b - 373
	34-19/110309	b - 309
м4		h/2 - 205

Высота (h), мм	Ширина (b), мм			Ручка
	$350 \leq b \leq 450$	$450 < b \leq 750$	$750 < b \leq 1200$	
$h \leq 1200$	34-19/110309 x1 34-19/111700 x1 34-19/111500 x1 34-19/R1113[xx] x1	34-19/B110302 x1 34-19/111700 x1 34-19/111500 x1 34-19/R1113[xx] x1	34-19/B110301 x1 34-19/111700 x1 34-19/111500 x1 34-19/R1113[xx] x1	34-19/A1154[xx]
$1200 < h \leq 2400$	34-19/110309 x1 34-19/111700 x1 34-19/111500 x1 34-19/R1113[xx] x1 34-19/A112100 x1	34-19/B110302 x1 34-19/111700 x1 34-19/111500 x1 34-19/R1113[xx] x1 34-19/A112100 x1	34-19/B110301 x1 34-19/111700 x1 34-19/111500 x1 34-19/R1113[xx] x1 34-19/A112100 x1	



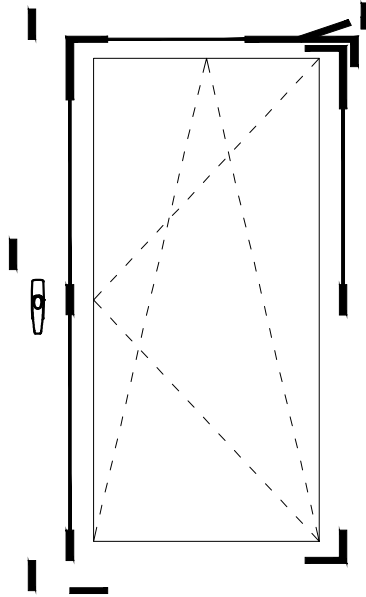

15-2313



Артикул	Наименование	350 <= ширина <= 636						636 < ширина <= 736					
		486 <= высота <= 586	586 < высота <= 636	636 < высота <= 786	786 < высота <= 1036	1036 < высота <= 1286	1286 < высота <= 1686	486 <= высота <= 586	586 < высота <= 636	636 < высота <= 786	786 < высота <= 1036	1036 < высота <= 1286	1286 < высота <= 1686
34-23/04315	Ручка оконная FGS 1758	1	1	1	1	1	1	1	1	1	1	1	1
34-27/A5001-00-N03	Навес рамы верхний со штифтом	1	1	1	1	1	1	1	1	1	1	1	1
34-27/A5002-00-N03	Навес рамы нижний со штифтом	1	1	1	1	1	1	1	1	1	1	1	1
34-27/A5010-09-R03 (34-27/A5010-09-L03)	Навес фальцевый правый (Навес фальцевый левый)	1	1	1	1	1	1	1	1	1	1	1	1
34-27/A6028-09-N03	Опора микролифта-блокиратора	1	1	1	1	1	1	1	1	1	1	1	1
34-27/A7001-00-N03	Микролифт-блокиратор	1	1	1	1	1	1	1	1	1	1	1	1
34-27/A7004-10-N0	Накладка навеса ножничного	1	1	1	1	1	1	1	1	1	1	1	1
34-27/A7005-10-N0	Накладка навеса верхнего	1	1	1	1	1	1	1	1	1	1	1	1
34-27/A7007-10-N0	Накладка навеса нижнего короткая	1	1	1	1	1	1	1	1	1	1	1	1
34-27/A7008-10-N0	Накладка навеса нижнего длинная	1	1	1	1	1	1	1	1	1	1	1	1
34-27/A7070-09-N03	Планка ответная	1	1	3	4	4	6	1	1	3	4	4	6
34-27/7085-00-R03 (34-27/7085-00-L03)	Накладка навеса фальцевого правого Накладка навеса фальцевого левого	1	1	1	1	1	1	1	1	1	1	1	1
34-27/K1001-02-N03	Привод поворотнo-откидной 450-550	1	0	0	0	0	0	1	0	0	0	0	0
34-27/K1001-04-N03	Привод поворотнo-откидной 551-750	0	1	1	0	0	0	0	1	1	0	0	0
34-27/K1001-09-N03	Привод поворотнo-откидной 751-1230 1V	0	0	0	1	0	0	0	0	0	1	0	0
34-27/K1001-11-N03	Привод поворотнo-откидной 950-1430 1V	0	0	0	0	1	0	0	0	0	0	1	0
34-27/K1001-14-N03	Привод поворотнo-откидной 1231-1710 2V	0	0	0	0	0	1	0	0	0	0	0	1
34-27/K2001-00-N03	Передача угловая 150x150 1V	1	1	1	1	1	1	1	1	1	1	1	1
34-27/K2005-00-N03	Передача угловая 150x150 1S	1	1	1	1	1	1	1	1	1	1	1	1
34-27/K3001-05-N03	Ножницы поворотнo-откидные L450 400-600	1	1	1	1	1	1	0	0	0	0	0	0
34-27/K3001-07-N03	Ножницы поворотнo-откидные L650 601-800	0	0	0	0	0	0	1	1	1	1	1	1
34-27/K4004-04-N03	Запор средний L400 600-1000 2V	0	0	1	1	0	0	0	0	1	1	0	0
34-27/K4004-06-N03	Запор средний L650 850-1250 2V	0	0	0	0	1	0	0	0	0	0	1	0
34-27/K4004-11-N03	Запор средний L1130 1251-1730 3V	0	0	0	0	0	1	0	0	0	0	0	1
34-27/K5006-09-N03	Навес створки верхний	1	1	1	1	1	1	1	1	1	1	1	1
34-27/S6120-09-R03 (34-27/S6120-09-L03)	Планка поворотнo-откидная противозломная правая (Планка поворотнo-откидная противозломная левая)	1	1	1	1	1	1	1	1	1	1	1	1
44-DIN75040 A2 3,9x13 TX15	Шуруп сверлоконечный с потайной головкой	8	8	8	8	8	8	8	8	8	8	8	8
44-DIN75040 A2 3,9x19 TX15	Шуруп сверлоконечный с потайной головкой	25	27	32	35	38	44	26	28	33	36	39	45



15-2110 15-2112 15-2130 15-2151 15-2152 15-2210 15-2212 15-2240 15-2220



15-2310 15-2312 15-2320

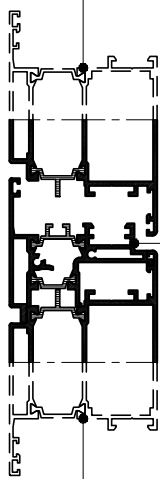

15-2412

15-2310 15-2312 15-2320



15-2110 15-2112 15-2130 15-2151 15-2152 15-2210 15-2212 15-2240 15-2220

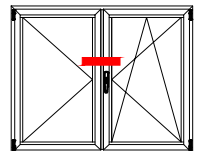

Шпингалет				Планка ответная			Примыкающий элемент
Внешний вид	Артикул	Наименование	Крепление	Внешний вид	Артикул	Крепление	Артикул
	34-19/111601	Комплект шпингалетов шульповых	В комплекте			В комплекте	15-2110 15-2130 15-2151 15-2210 15-2240



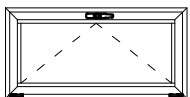
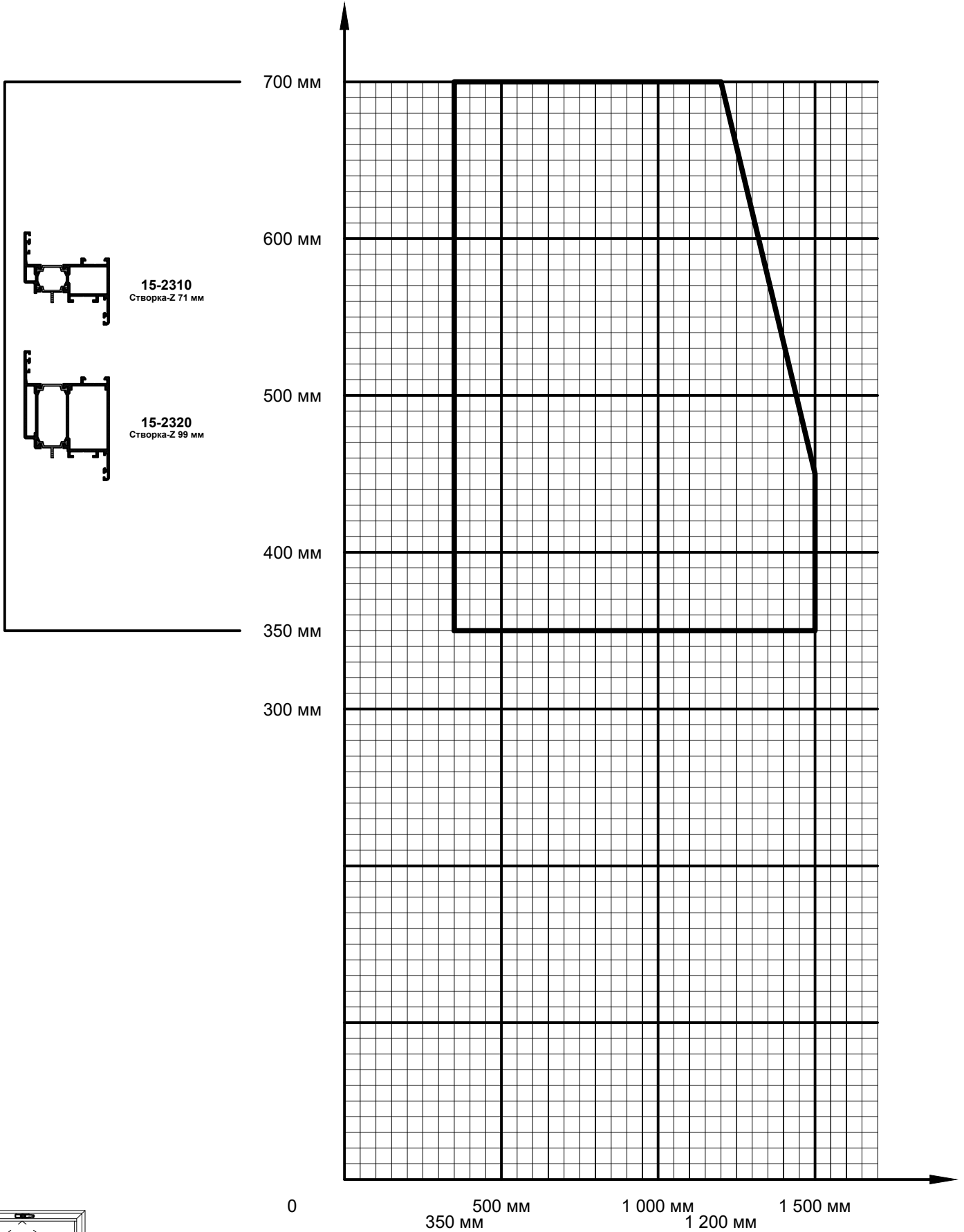

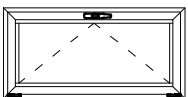
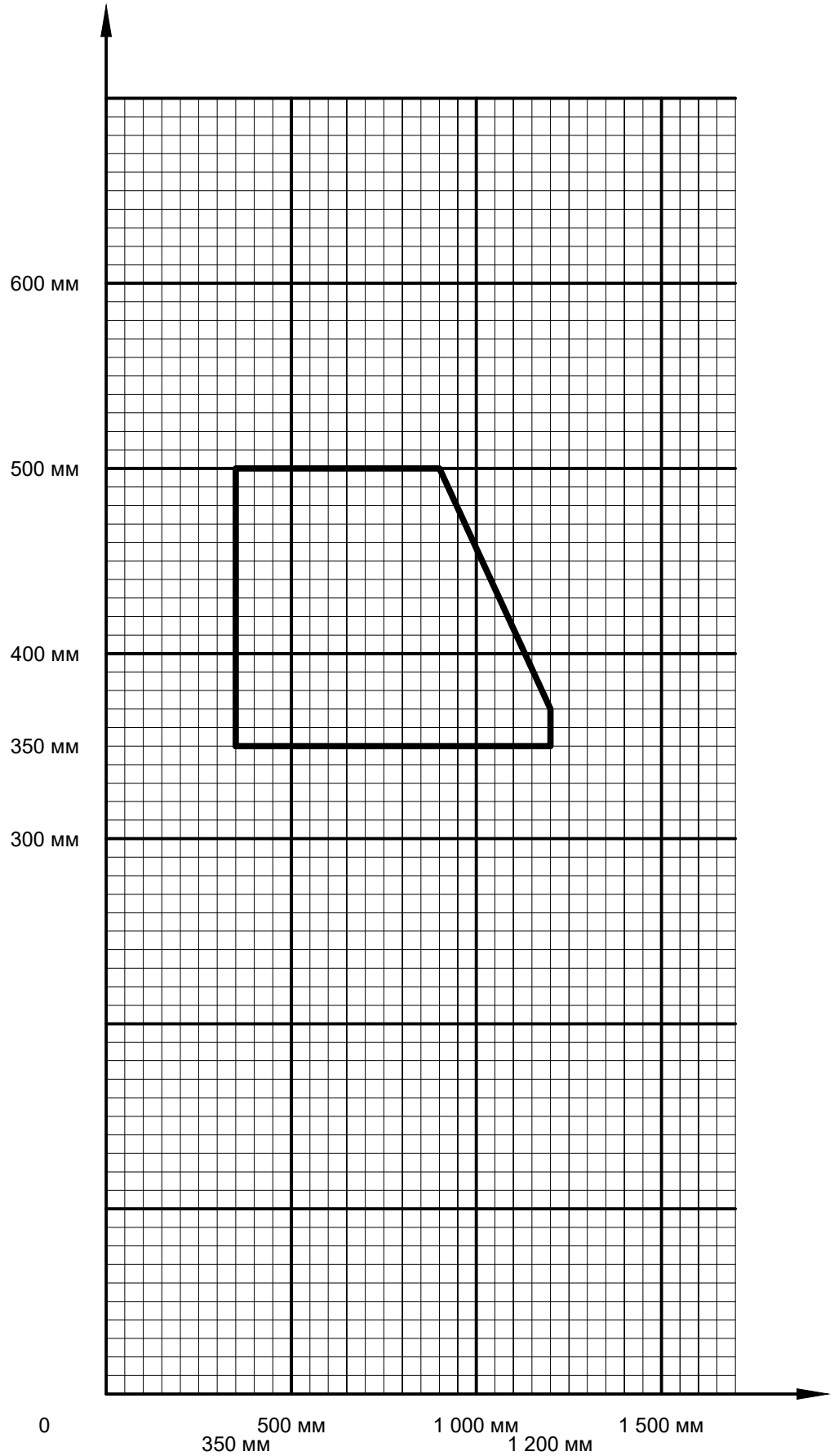
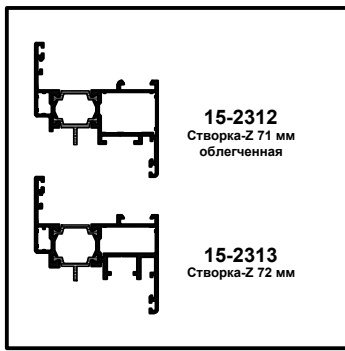

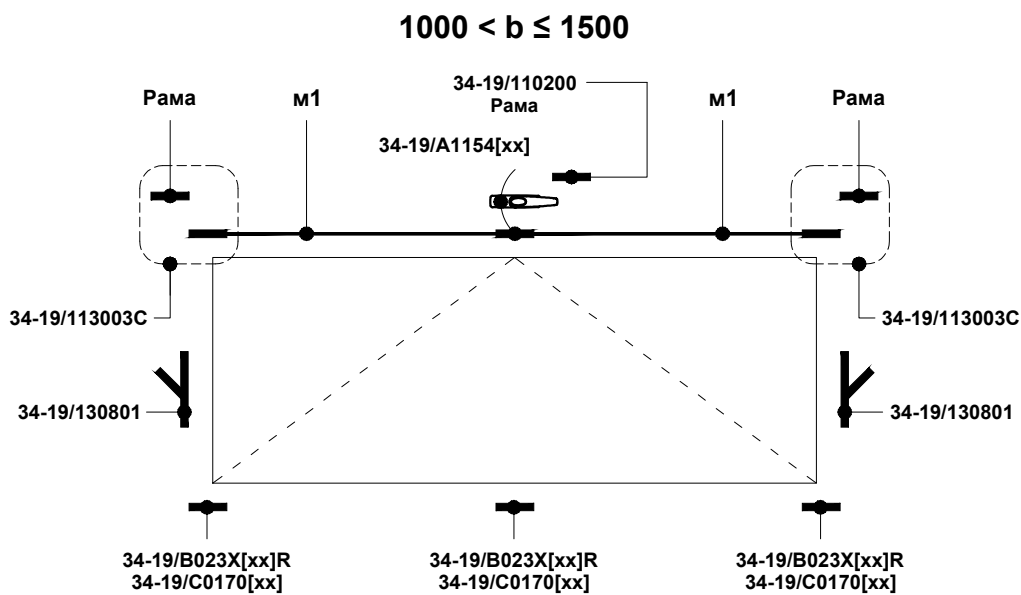
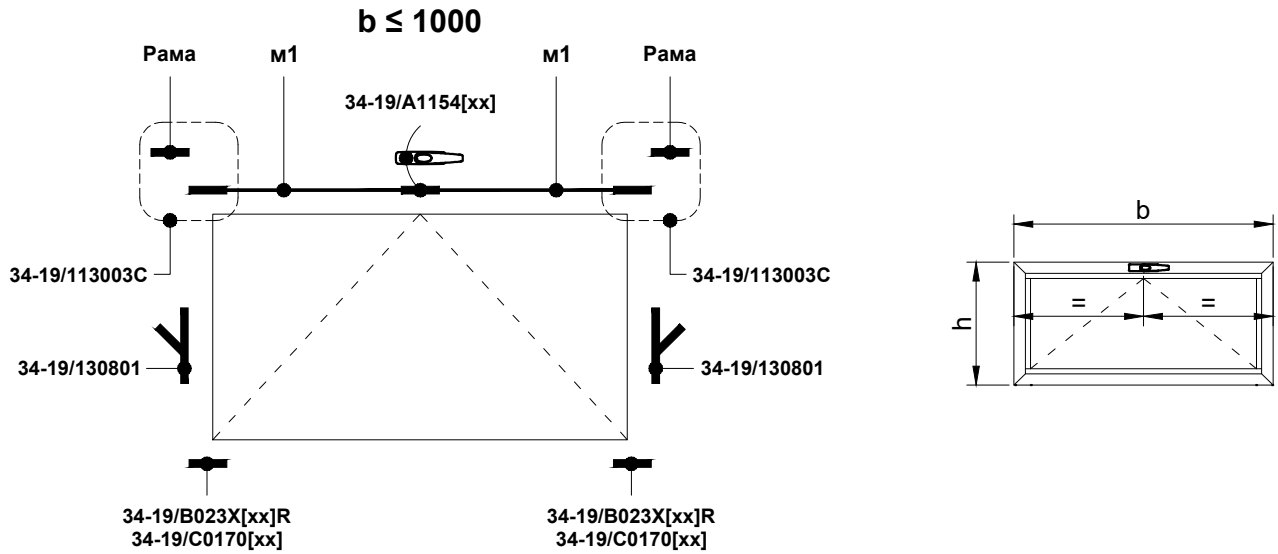

Муфель	Длина, мм
м1	$h/2 - 205$

Вес створки, кг	Навес	Ограничитель открывания	Ручка	Запорная часть		Ограничения	
				$b \leq 1000$	$1000 < b \leq 1500$	Ширина	Высота
≤ 15	34-19/B023X[xx]R	34-19/130801 x2	34-19/A1154[xx]	34-19/113003C x2	34-19/113003C x2	см. диаграмму	
≤ 30	34-19/C0170[xx]						



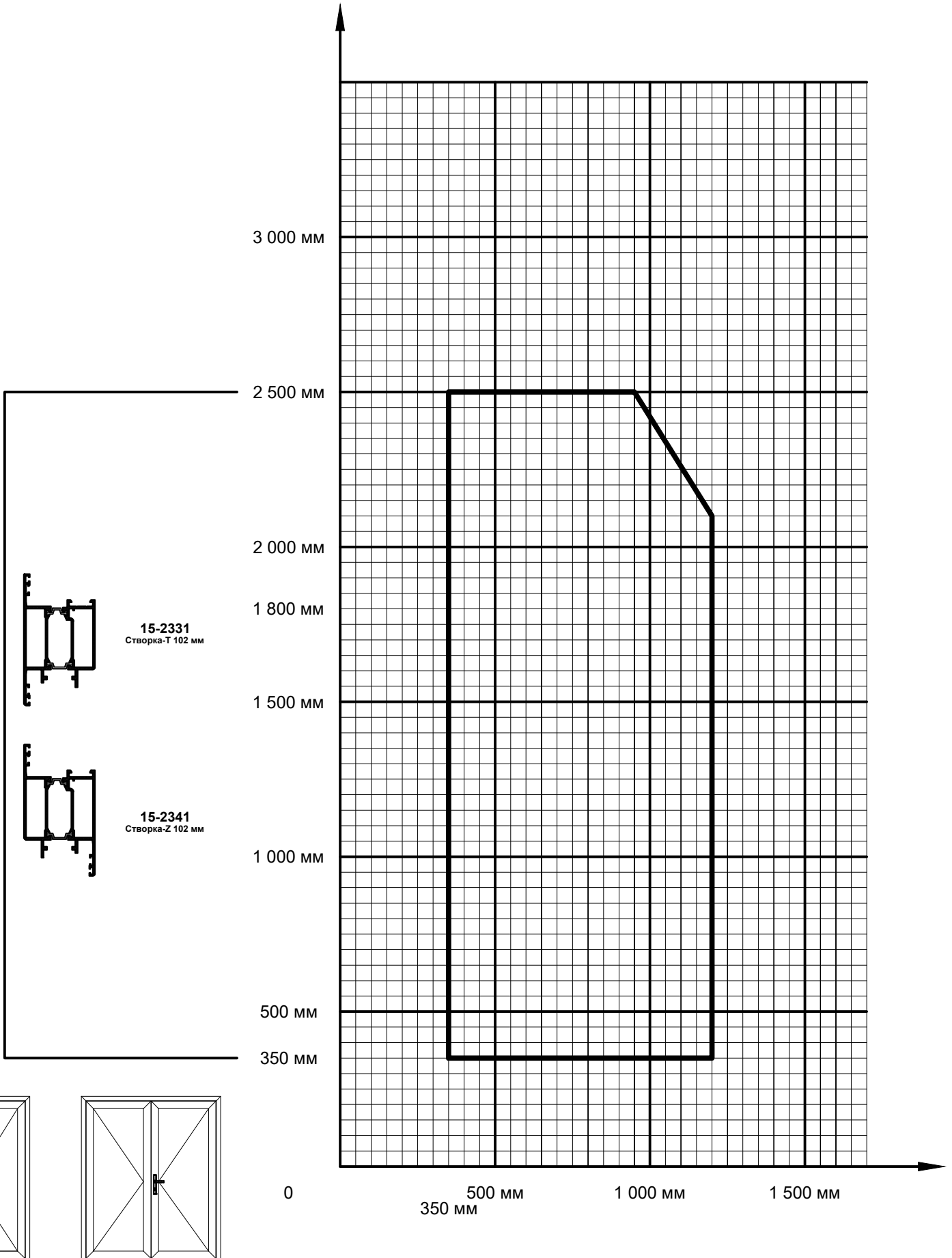

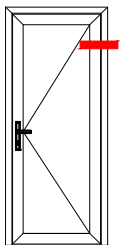
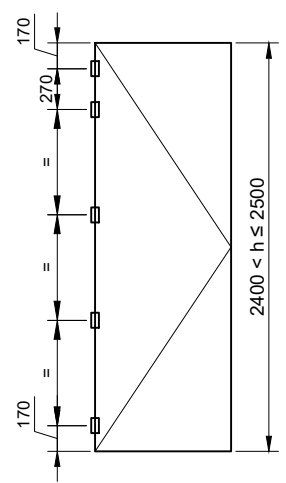
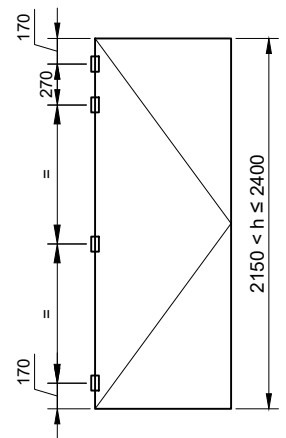
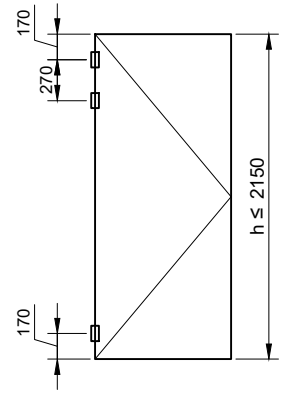
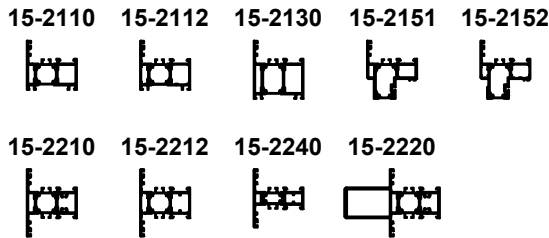
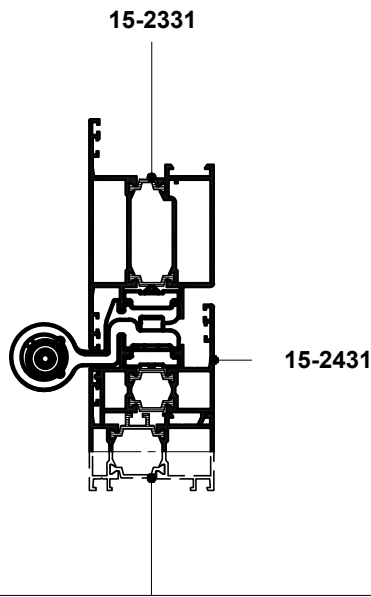
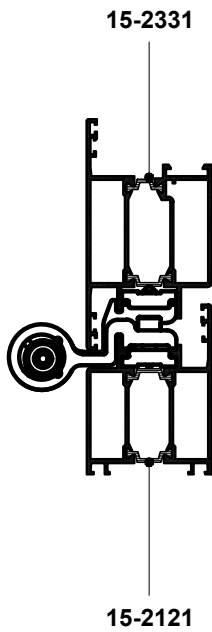

Навес			Крепление		
Внешний вид	Артикул	Наименование	Внешний вид	Артикул	Наименование
	34-20/XWWW8010439	Навес дверной двухчастный WALA XWWW		В комплекте	В комплекте
	34-14/00000365	Навес дверной двухчастный ППЕ-2		В комплекте	В комплекте



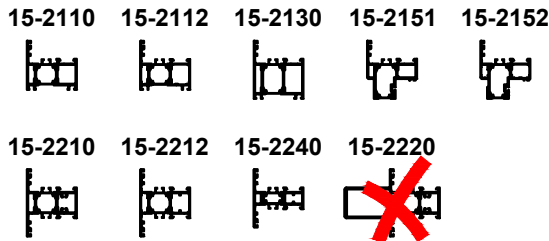
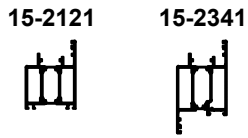
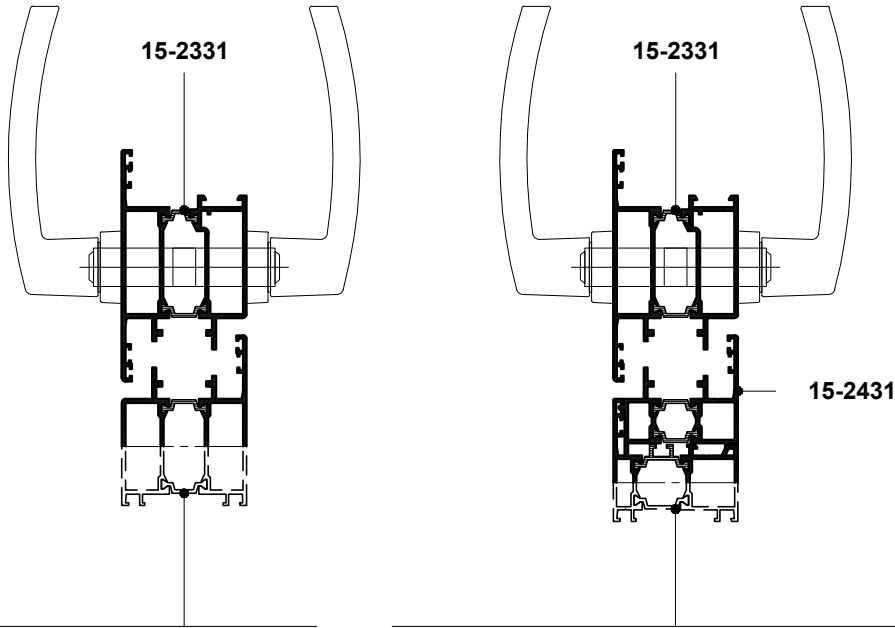

34-02/1615-03

34-19/05182[xx]

34-04/0000008030093

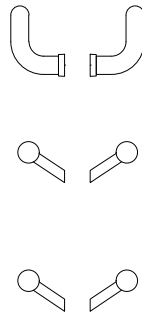

34-02/0206.350

34-20/WUP0000001059

34-20/WUP0000001067

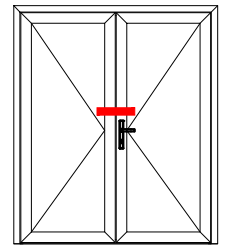
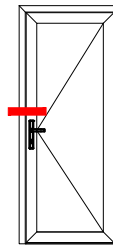

Ручка				Накладка			Цилиндр фигурный
Внешний вид	Артикул	Наименование	Крепление	Внешний вид	Артикул	Крепление	Артикул
	34-02/1615-03	Гарнитур нажимной 32/92/66-75	46-DIN966 A2 M5x70 TX25 x3	-	-	-	34-01/0003/4040
	34-19/05182[xx]	Комплект ручек нажимных POLARIS	46-DIN965 Zn M5x16 TX25 x8 40-ART1021 A2 M5x11,5 x8		34-19/0508053[xx] x2	41-DIN7981C A2 3,9x13 TX15 x4	34-01/0003/3535
	34-04/0000008030093	Комплект ручек нажимных с накладками	В комплекте	В комплекте	В комплекте	В комплекте	34-01/0003/4040
	34-02/0206.350	Комплект ручек дверных стационарных	В комплекте		34-19/0508053[xx] x2	41-DIN7981C A2 3,9x13 TX15 x4	34-01/0003/3535
	34-20/WUP0000001059	Комплект ручек 1200-1400 мм с креплением	В комплекте		34-23/0000417611	43-DIN7982C A2 3,9x13 TX15 x4	34-01/0003/4040
	34-20/WUP0000001067	Комплект ручек 300-500 мм с креплением	В комплекте		34-23/0000417611	43-DIN7982C A2 3,9x13 TX15 x4	34-01/0003/4040



15-2331

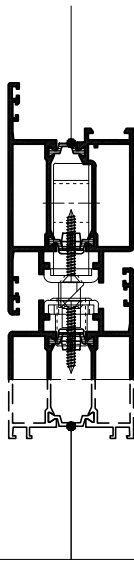

15-2331

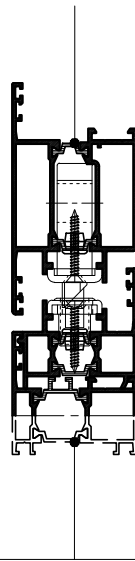

15-2431

15-2121



15-2341

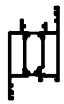

15-2110



15-2112



15-2130



15-2151



15-2152



15-2210



15-2212



15-2240



15-2220

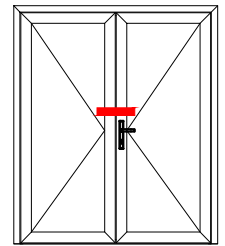
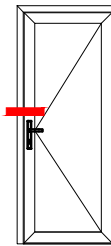

Ручка	Замок				Планка ответная		
	Внешний вид	Артикул	Наименование	Крепление	Внешний вид	Артикул	Крепление
Нажимные 34-02/1615-03 Гарнитура нажимной 32/92/66-75 34-19/05182[xx] Комплект ручек нажимных POLARIS 34-04/0000008030093 Комплект ручек нажимных с накладками		34-22/3469528	Замок клиновый KFV RES 49N 24x6/92/35	32-0001 x2 43-DIN7982C A2 3,9x32 TX15 x2		34-22/3477532 лев 34-22/3477533 прав	32-0001 x3 43-DIN7982C A2 3,9x32 TX15 x3
		34-04/1100000009810	Замок клиновый 24x3/92/35	34-04/1100000009939 32-0001 x2 43-DIN7982C A2 3,9x32 TX15 x2	-	В комплекте	
		34-22/3488093	Замок M3K KFV AS2300 24x6x1880-2170/35/92	32-0001 x10 43-DIN7982C A2 3,9x32 TX15 x10		34-22/3478553 лев 34-22/3478552 прав	32-0001 x10 43-DIN7982C A2 3,9x32 TX15 x10
		34-22/3492892	Замок M3K KFV AS2750 24x6x1880-2170/35/92	32-0001 x10 43-DIN7982C A2 3,9x32 TX15 x10		34-22/3478553 лев 34-22/3478552 прав	32-0001 x10 43-DIN7982C A2 3,9x32 TX15 x10
Стационарные 34-02/0206.350 Комплект ручек дверных стационарных 34-20/WUP0000001059 Комплект ручек 1200-1400 мм с креплением 34-20/WUP0000001067 Комплект ручек 300-500 мм с креплением		34-22/3469528	Замок клиновый KFV RES 49N 24x6/92/35	32-0001 x2 43-DIN7982C A2 3,9x32 TX15 x2		34-22/3477532 лев 34-22/3477533 прав 34-22/3493198	32-0001 x3 43-DIN7982C A2 3,9x32 TX15 x3
		34-04/1100000009820	Замок роликовый 24x3/92/35	34-04/1100000009939 32-0001 x2 43-DIN7982C A2 3,9x32 TX15 x2	-	В комплекте	
		34-22/3488093	Замок M3K KFV AS2300 24x6x1880-2170/35/92	32-0001 x10 43-DIN7982C A2 3,9x32 TX15 x10		34-22/3478553 лев 34-22/3493198 34-22/3478552 прав 34-22/3493198	32-0001 x10 43-DIN7982C A2 3,9x32 TX15 x10



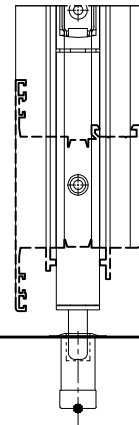
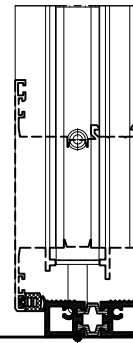
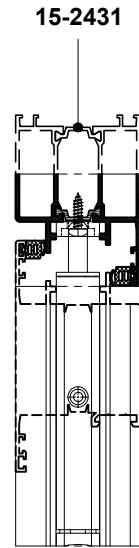
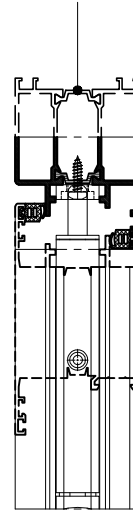
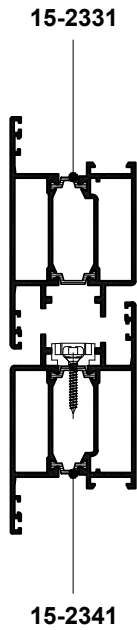

15-2170

34-20/WR00000000107

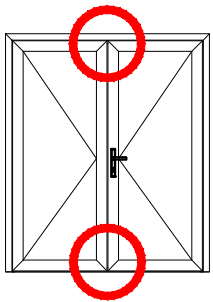

Шпингалет				Планка ответная			Примыкающий элемент
Внешний вид	Артикул	Наименование	Крепление	Внешний вид	Артикул	Крепление	Артикул
	34-19/052402[xx]	Шпингалет 19x8x220	В комплекте		34-03/3012.20	В комплекте	15-2121 15-2431
				-	-	-	15-2170
					34-20/WR00000000107	-	Пол



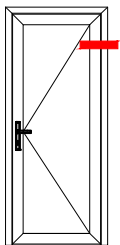
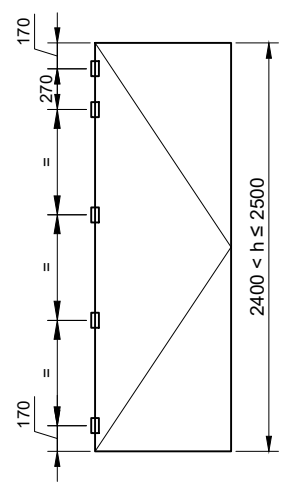
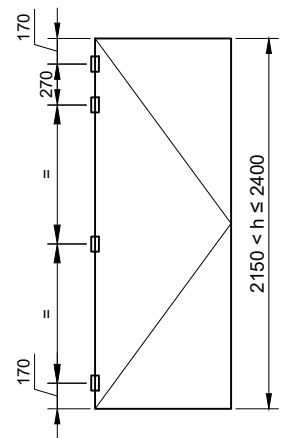
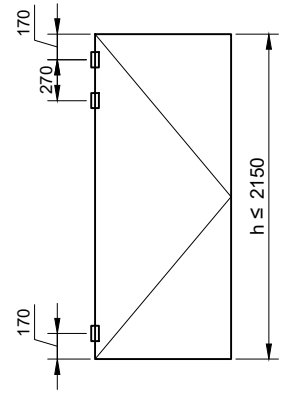
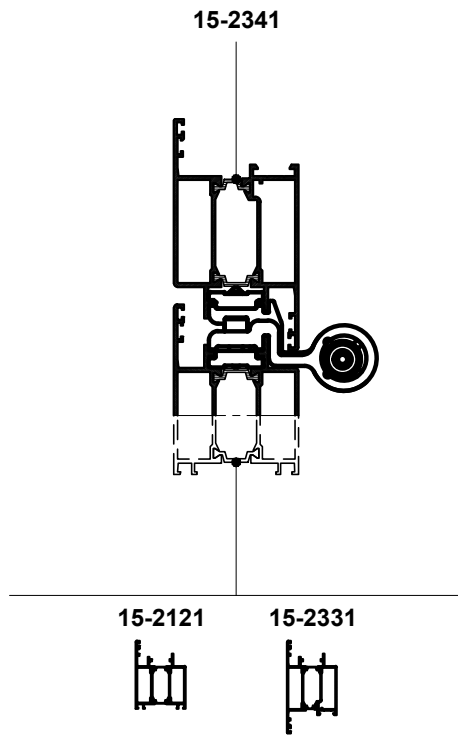

Навес			Крепление		
Внешний вид	Артикул	Наименование	Внешний вид	Артикул	Наименование
	34-20/XWWW8010439	Навес дверной двухчастный WALA XWWW	В комплекте	В комплекте	В комплекте
	34-14/00000365	Навес дверной двухчастный ППЕ-2	В комплекте	В комплекте	В комплекте



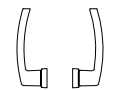
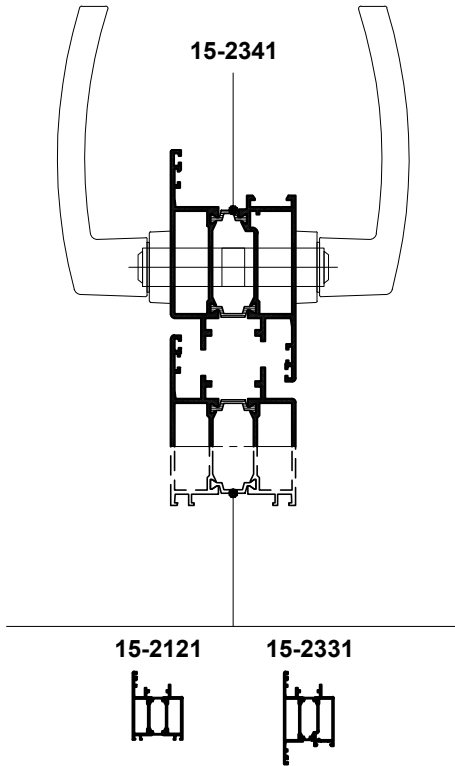

34-02/1615-03

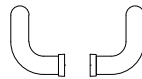

34-02/0206.350

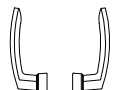

34-19/05182[xx]

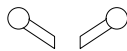

34-20/WUP0000001059

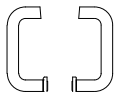

34-04/0000008030093

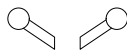

34-20/WUP0000001067

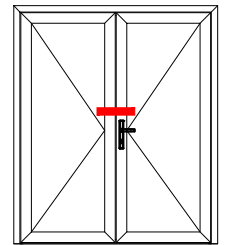
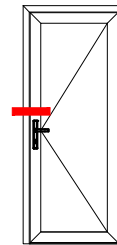

Ручка				Накладка			Цилиндр фигурный
Внешний вид	Артикул	Наименование	Крепление	Внешний вид	Артикул	Крепление	Артикул
	34-02/1615-03	Гарнитур нажимной 32/92/66-75	46-DIN966 A2 M5x70 TX25 x3	-	-	-	34-01/0003/4040
	34-19/05182[xx]	Комплект ручек нажимных POLARIS	46-DIN965 Zn M5x16 TX25 x8 40-ART1021 A2 M5x11,5 x8		34-19/0508053[xx] x2	41-DIN7981C A2 3,9x13 TX15 x4	34-01/0003/3535
	34-04/0000008030093	Комплект ручек нажимных с накладками	В комплекте	В комплекте	В комплекте	В комплекте	34-01/0003/4040
	34-02/0206.350	Комплект ручек дверных стационарных	В комплекте		34-19/0508053[xx] x2	41-DIN7981C A2 3,9x13 TX15 x4	34-01/0003/3535
	34-20/WUP0000001059	Комплект ручек 1200-1400 мм с креплением	В комплекте		34-23/0000417611	43-DIN7982C A2 3,9x13 TX15 x4	34-01/0003/4040
	34-20/WUP0000001067	Комплект ручек 300-500 мм с креплением	В комплекте		34-23/0000417611	43-DIN7982C A2 3,9x13 TX15 x4	34-01/0003/4040



15-2341

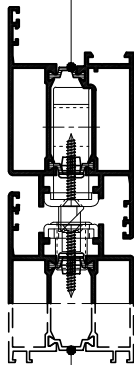

15-2121



15-2331

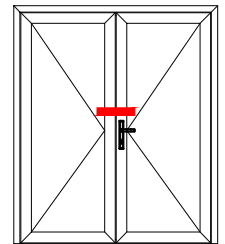
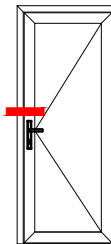

Ручка	Замок				Планка ответная		
	Внешний вид	Артикул	Наименование	Крепление	Внешний вид	Артикул	Крепление
Нажимные 34-02/1615-03 Гарнитура нажимной 32/92/66-75 34-19/05182[xx] Комплект ручек нажимных POLARIS 34-04/0000008030093 Комплект ручек нажимных с накладками		34-22/3469528	Замок клиновидный KJV RES 49N 24x6/92/35	32-0001 x2 43-DIN7982C A2 3,9x32 TX15		34-22/3477532 лев	32-0001 x3 43-DIN7982C A2 3,9x32 TX15
				32-0001 x2 43-DIN7982C A2 3,9x32 TX15		34-22/3477533 прав	32-0001 x3 43-DIN7982C A2 3,9x32 TX15
		34-04/1100000009810	Замок клиновидный 24x3/92/35	34-04/1100000009939 32-0001 x2 43-DIN7982C A2 3,9x32 TX15	-	В комплекте	32-0001 x3 43-DIN7982C A2 3,9x32 TX15
				32-0001 x10 43-DIN7982C A2 3,9x32 TX15	34-22/3488093		Замок M3K KJV AS2300 24x6x1880-2170/35/92
	34-22/3492892	Замок M3K KJV AS2750 24x6x1880-2170/35/92	32-0001 x10 43-DIN7982C A2 3,9x32 TX15	34-22/3478552 прав	32-0001 x10 43-DIN7982C A2 3,9x32 TX15		
			32-0001 x10 43-DIN7982C A2 3,9x32 TX15	34-22/3478553 лев	32-0001 x10 43-DIN7982C A2 3,9x32 TX15		
Стационарные 34-02/0206.350 Комплект ручек дверных стационарных 34-20/WUP0000001059 Комплект ручек 1200-1400 мм с креплением 34-20/WUP0000001067 Комплект ручек 300-500 мм с креплением		34-22/3469528	Замок клиновидный KJV RES 49N 24x6/92/35	32-0001 x2 43-DIN7982C A2 3,9x32 TX15		34-22/3477532 лев	32-0001 x3 43-DIN7982C A2 3,9x32 TX15
				32-0001 x2 43-DIN7982C A2 3,9x32 TX15		34-22/3477533 прав	32-0001 x3 43-DIN7982C A2 3,9x32 TX15
		34-04/1100000009820	Замок роликовый 24x3/92/35	34-04/1100000009939 32-0001 x2 43-DIN7982C A2 3,9x32 TX15	-	В комплекте	32-0001 x3 43-DIN7982C A2 3,9x32 TX15
				32-0001 x10 43-DIN7982C A2 3,9x32 TX15	34-22/3488093		Замок M3K KJV AS2300 24x6x1880-2170/35/92
	34-22/3488093	Замок M3K KJV AS2300 24x6x1880-2170/35/92	32-0001 x10 43-DIN7982C A2 3,9x32 TX15	34-22/3478552 прав	32-0001 x10 43-DIN7982C A2 3,9x32 TX15		
			32-0001 x10 43-DIN7982C A2 3,9x32 TX15	34-22/3493198	32-0001 x10 43-DIN7982C A2 3,9x32 TX15		



15-2341

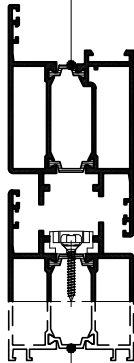

15-2121 15-2331

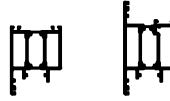

15-2121 15-2331

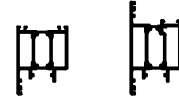

15-2121

15-2331

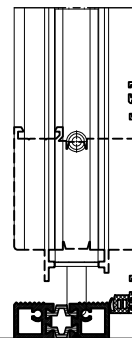
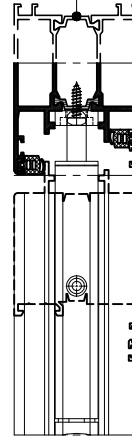

15-2170

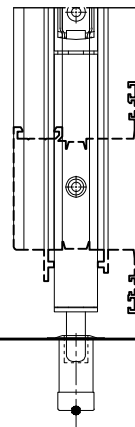
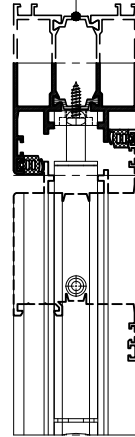

34-20/WR00000000107

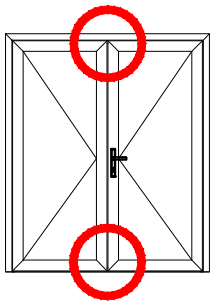

Шпингалет				Планка ответная			Примыкающий элемент
Внешний вид	Артикул	Наименование	Крепление	Внешний вид	Артикул	Крепление	Артикул
	34-19/052402[xx]	Шпингалет 19x8x220	В комплекте		34-03/3012.20	В комплекте	15-2121 15-2431
				-	-	-	15-2170
					34-20/WR00000000107	-	Пол



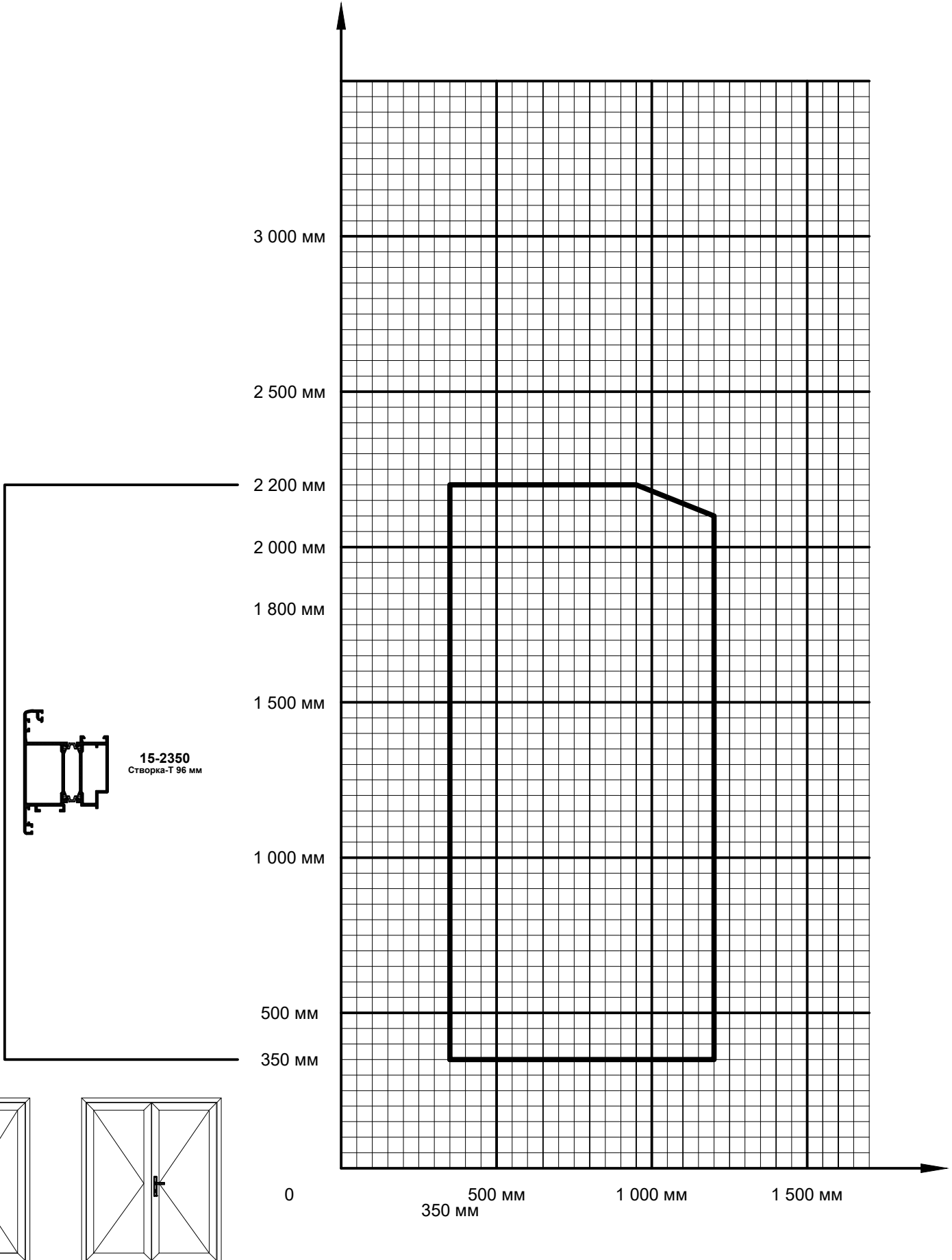

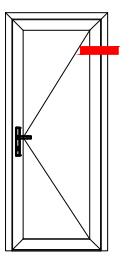
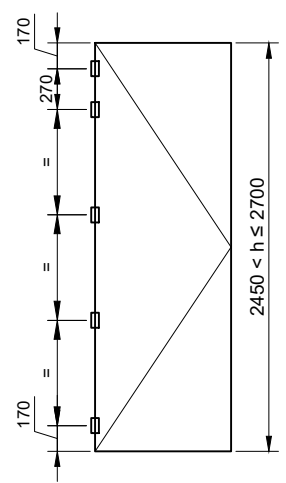
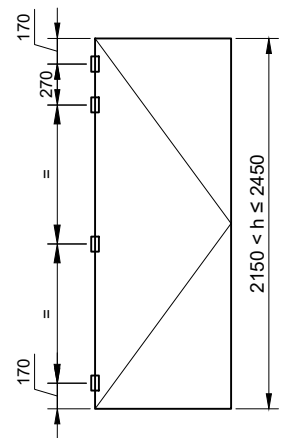
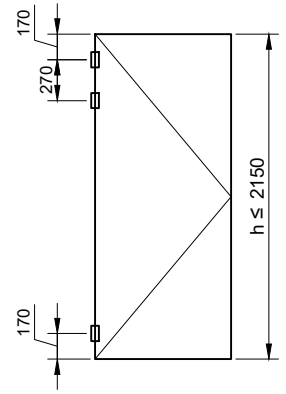
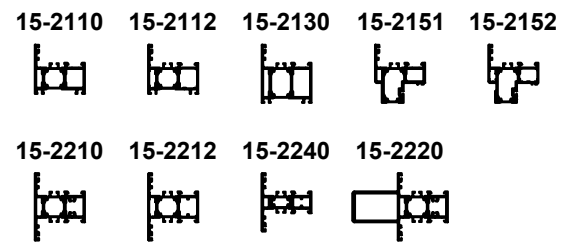
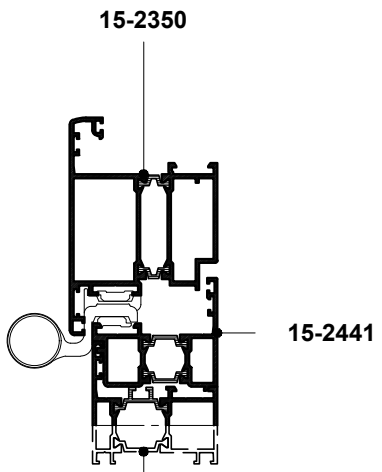
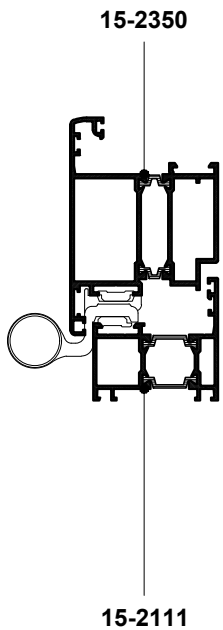

Навес			Крепление
Внешний вид	Артикул	Наименование	
	34-19/A011X[xx]	Навес двухчастный TAURUS	В комплекте



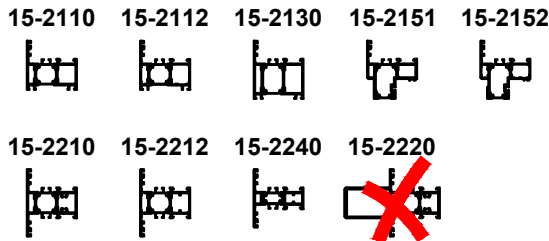
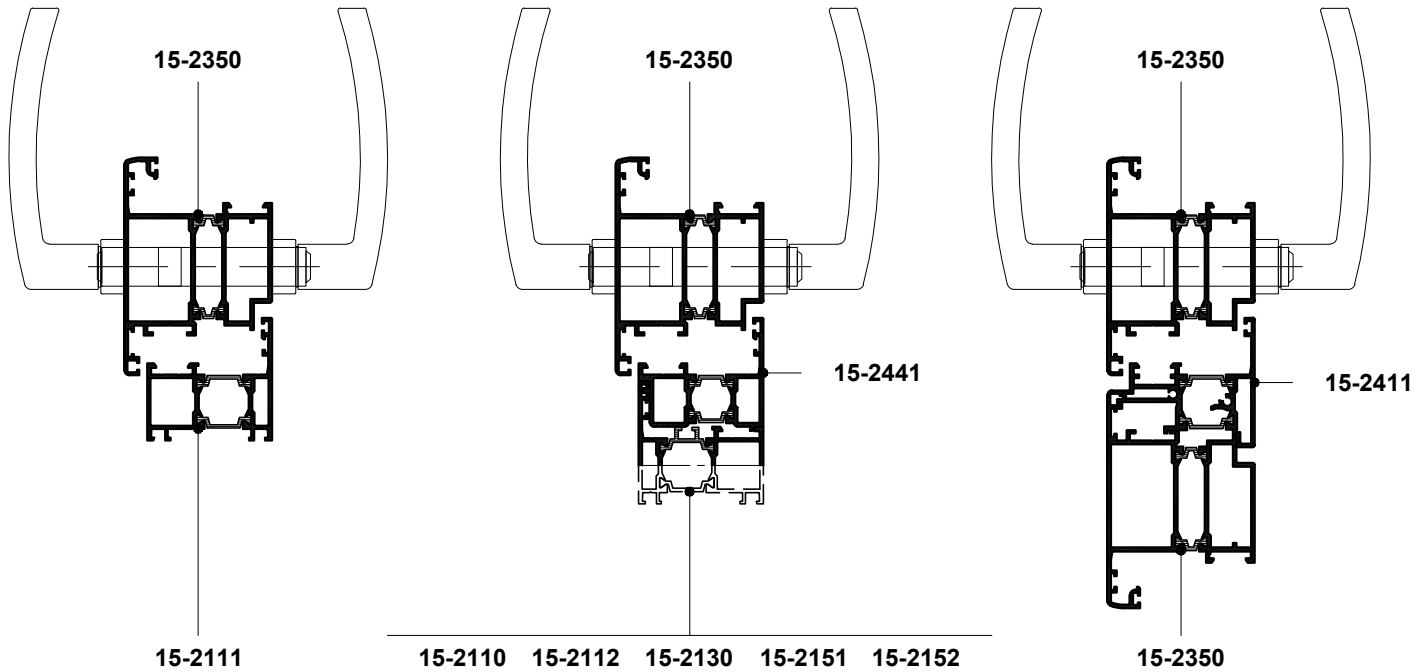

34-02/1615-03

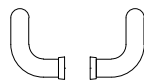

34-02/0206.350



34-02/1700-04

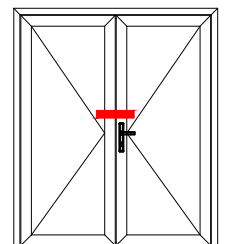
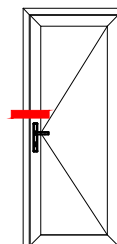

Ручка				Накладка			Цилиндр фигурный
Внешний вид	Артикул	Наименование	Крепление	Внешний вид	Артикул	Крепление	Артикул
	34-02/1615-03	Гарнитур нажимной 32/92/66-75	46-DIN966 A2 M5x70 TX25 x3	-	-	-	34-01/0003/3555
	34-02/1700-04	Гарнитур нажимной 24/92/76-84	46-DIN966 A2 M5x80 TX25 x3	-	-	-	34-01/0003/3555
	34-02/0206.350	Комплект ручек дверных стационарных	В комплекте		34-14/00001474	43-DIN7982C A2 3,9x13 TX15 x4	34-01/0003/3555



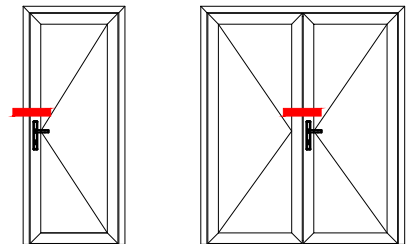
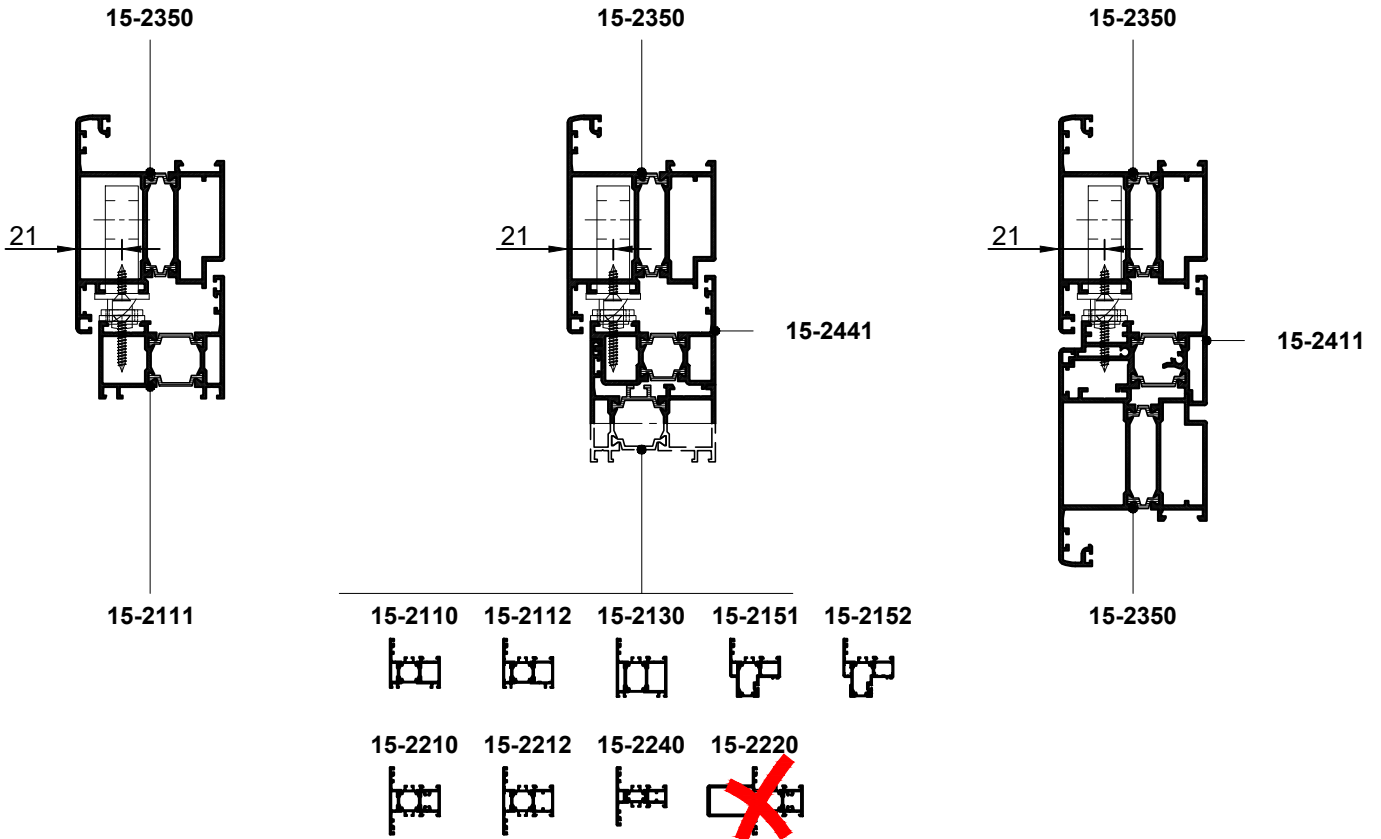

Замок				Планка ответная			Ручка
Внешний вид	Артикул	Наименование	Крепление	Внешний вид	Артикул	Крепление	
	34-04/110000009810	Замок клиновыи 24x3/92/35	34-04/110000009939 43-DIN7982C A2 3,9x16 TX15 x2		34-16/CT7777	43-DIN7982C A2 3,9x25 TX15 x3	34-02/1700-04 Гарнитура нажимной 24/92/76-84 34-02/1615-03 Гарнитура нажимной 32/92/66-75
	34-04/110000009820	Замок роликовый 24x3/92/35	34-04/110000009939 43-DIN7982C A2 3,9x16 TX15 x2		34-16/CT7777	43-DIN7982C A2 3,9x25 TX15 x3	34-02/0206.350 Комплект ручек дверных стационарных



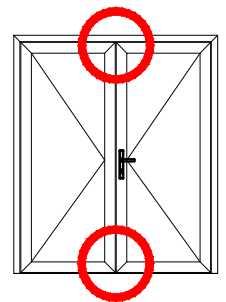
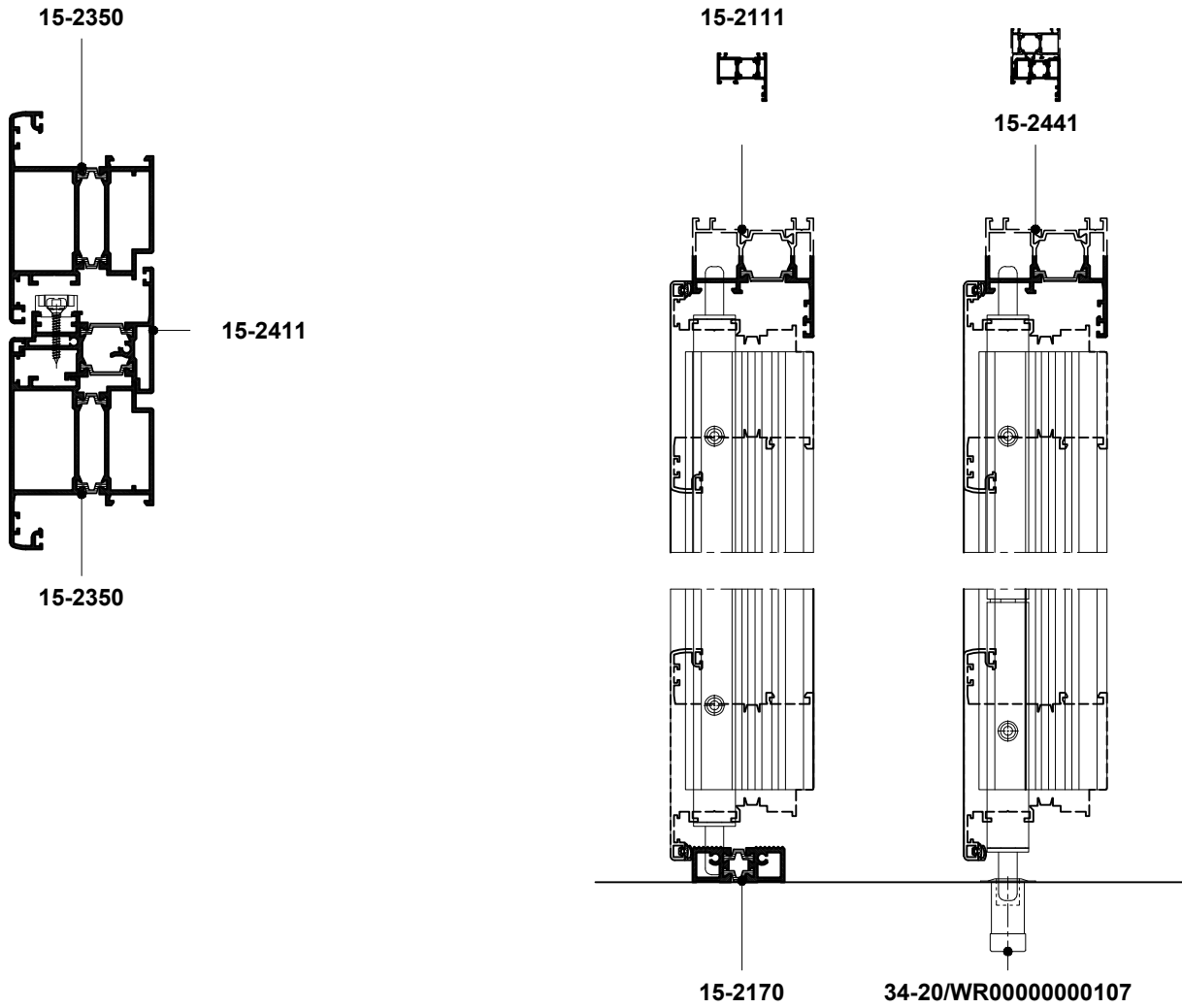

Шпингалет				Планка ответная			Примыкающий элемент
Внешний вид	Артикул	Наименование	Крепление	Внешний вид	Артикул	Крепление	Артикул
	34-19/052402[xx]	Шпингалет 19x8x220	В комплекте	-	-	-	15-2111 15-2170 15-2441
					34-20/WR00000000107	-	Пол



15-2310



15-2320

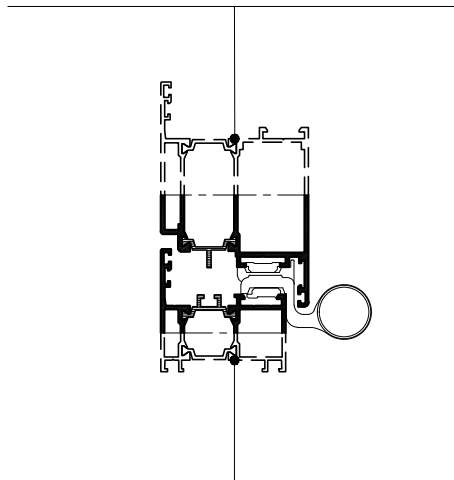

15-2110



15-2130



15-2151



15-2210



15-2240



15-2220

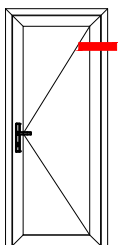
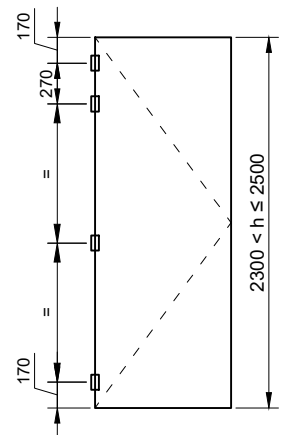
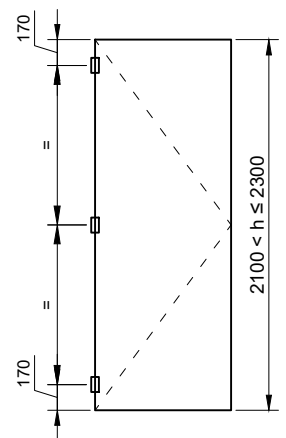
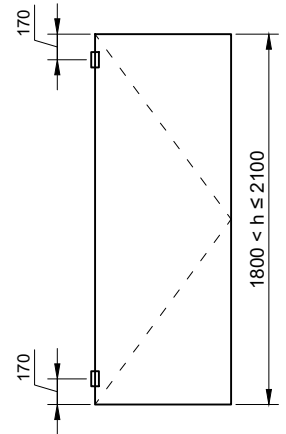

Навес			Ограничения		
Внешний вид	Артикул	Наименование	Ширина створки	Высота створки	Вес створки
	34-19/A011X[xx]	Навес двухчастный TAURUS	≤ 1200	≤ 2500	90 кг



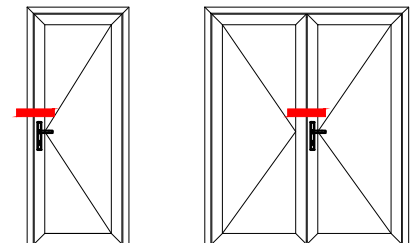
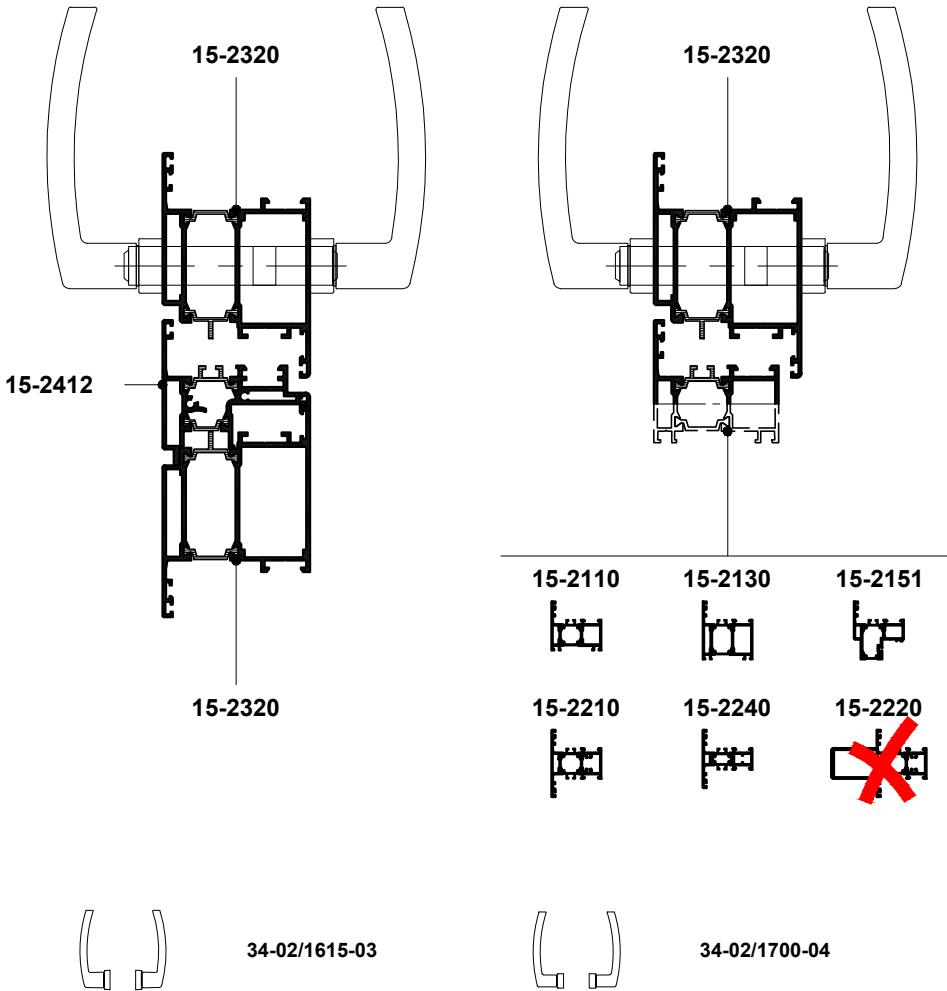

Ручка				Накладка			Цилиндр фигурный
Внешний вид	Артикул	Наименование	Крепление	Внешний вид	Артикул	Крепление	Артикул
	34-02/1615-03	Гарнитур нажимной 32/92/66-75	46-DIN966 A2 M5x70 TX25 x3	-	-	-	34-01/0003/3060
	34-02/1700-04	Гарнитур нажимной 24/92/76-84	46-DIN966 A2 M5x80 TX25 x3	-	-	-	34-01/0003/3060



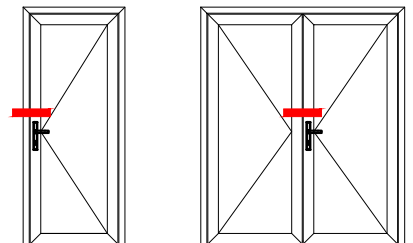
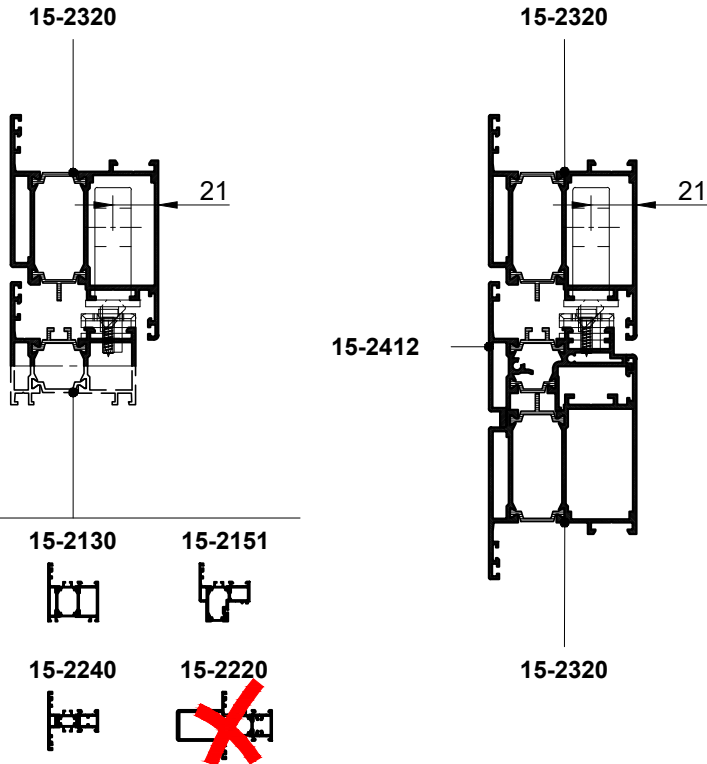

Замок				Планка ответная			Ручка
Внешний вид	Артикул	Наименование	Крепление	Внешний вид	Артикул	Крепление	
	34-22/3506068	Замок МЗК KFV AS2750 24x3x2130-2400/35/92	43-DIN7982C A2 3,9x16 TX15 x10		34-03/3093.00 34-22/3478743 доп x2	43-DIN7982C A2 3,9x16 TX15 x7	34-02/1700-04 Гарнитура нажимной 24/92/76-84
					34-03/3093.00 34-22/3478743 доп x2		



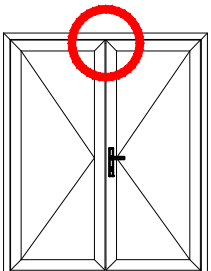
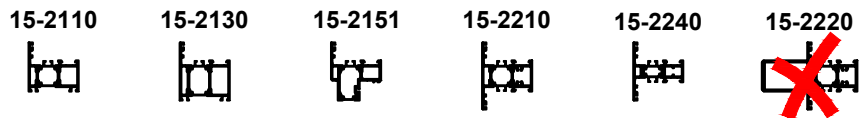
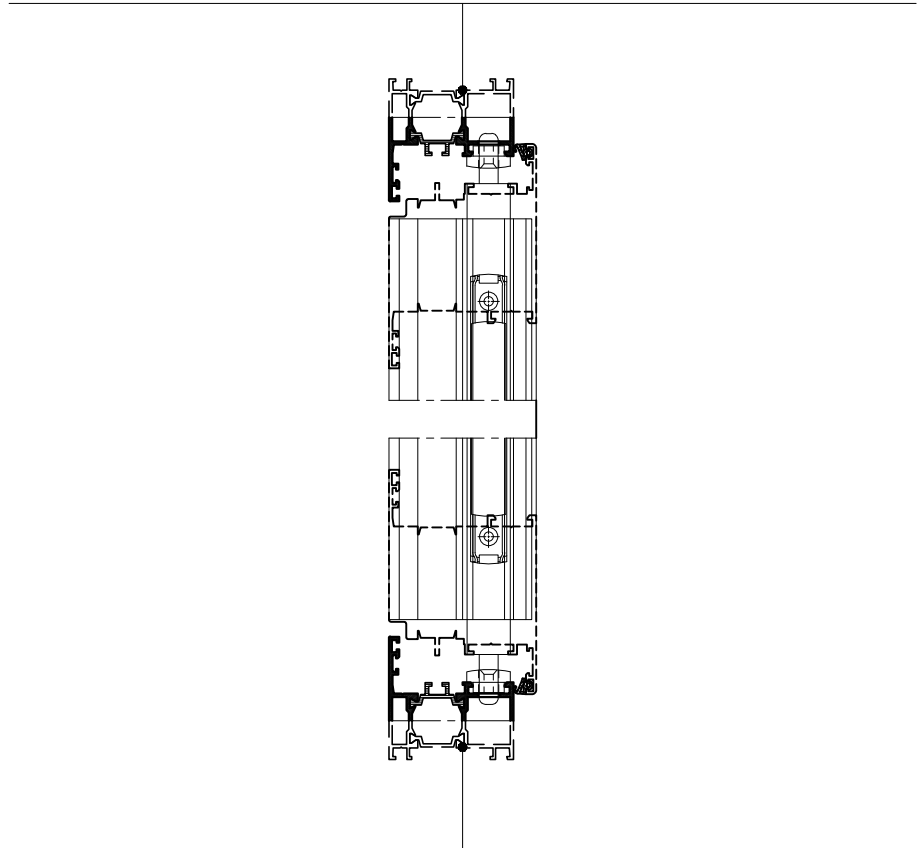
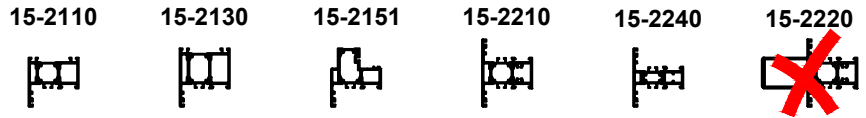
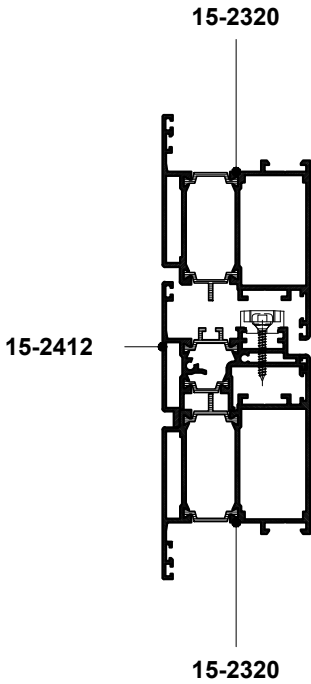

Шпингалет				Планка ответная			Примыкающий элемент
Внешний вид	Артикул	Наименование	Крепление	Внешний вид	Артикул	Крепление	Артикул
	34-19/052401[xx]	Шпингалет 19x8x140	В комплекте		34-19/0524020	В комплекте	15-2110 15-2130 15-2151 15-2210 15-2240

