



## СОДЕРЖАНИЕ

- |            |  |
|------------|--|
| <b>01.</b> | Содержание, оглавление, термины                            |
| <b>02.</b> | Профили  |
| <b>03.</b> | Уплотнители, пластиковые адаптеры и вставки,<br>термомосты |
| <b>04.</b> | Комплектующие и аксессуары                                 |
| <b>05.</b> | Сечения  |
| <b>06.</b> | Узлы   |
| <b>07.</b> | Остекление   |
| <b>08.</b> | Фурнитура  |
| <b>09.</b> | Сборка   |



Сечение	Артикул Наименование	$I_x$ см <sup>4</sup>	$W_x$ см <sup>3</sup>	$S$ см <sup>2</sup>
		$I_y$ см <sup>4</sup>	$W_y$ см <sup>3</sup>	$P$ мм
	<b>12-2110</b> Рама 59 мм	23,46 8,35	6,53 2,20	4,365 387
	<b>12-2111</b> Рама 59 мм для створки-Т	23,46 8,35	6,53 2,20	4,365 387

Профиль	Сухари		Химия	Комплектующие			
	Чаша I	Чаша II		Сбивка угла на прессе		Сборка угла на штифтах	
				Чаша I	Чаша II	Чаша I	Чаша II
Соединение L							
12-2110	20-0200/0059	20-0200/0266		31-0010		40-DIN1481 A2 D5x12 31-0010 x2	40-DIN1481 A2 D5x12 x2
12-2111	20-0200/0266	20-0200/0059			31-0010	40-DIN1481 A2 D5x12 x2	40-DIN1481 A2 D5x12 31-0010 x2
Соединение T							
12-2110	20-1051/0207	20-1261/0207				40-DIN1481 A2 D3x12 40-DIN916 A2 M5x6 HEX2,5 x2	40-DIN1481 A2 D5x12 42-DIN7504M A2 4,2x50 TX20 x2



Сечение	Артикул Наименование	$I_x$ см <sup>4</sup>	$W_x$ см <sup>3</sup>	$S$ см <sup>2</sup>
		$I_y$ см <sup>4</sup>	$W_y$ см <sup>3</sup>	$P$ мм
	<b>12-2130</b> Рама 69 мм	$\frac{27,11}{14,63}$	$\frac{7,51}{3,42}$	$\frac{5,026}{427}$
	<b>12-2131</b> Рама 69 мм для створки-Т	$\frac{27,11}{14,63}$	$\frac{7,51}{3,42}$	$\frac{5,026}{427}$

Профиль	Сухари		Химия	Комплекующие			
	Чаша I	Чаша II		Сбивка угла на прессе		Сборка угла на штифтах	
				Чаша I	Чаша II	Чаша I	Чаша II
Соединение L							
12-2130	20-0300/0059	20-0300/0266		31-0010		40-DIN1481 A2 D5x12 x2 31-0010	40-DIN1481 A2 D5x12 x2
12-2131	20-0300/0266	20-0300/0059			31-0010	40-DIN1481 A2 D5x12 x2	40-DIN1481 A2 D5x12 x2 31-0010
Соединение T							
12-2130	20-1051/0307	20-1261/0307				40-DIN1481 A2 D3x12 x2 40-DIN916 A2 M5x6 HEX2,5	40-DIN1481 A2 D5x12 x2 42-DIN7504M A2 4,2x50 TX20



Сечение			Артикул	$I_x$ см <sup>4</sup>	$W_x$ см <sup>3</sup>	$S$ см <sup>2</sup>
			Наименование	$I_y$ см <sup>4</sup>	$W_y$ см <sup>3</sup>	$P$ мм
			<p><b>12-2132</b> Рама 120 мм</p>			

Профиль	Сухари		Химия	Комплектующие			
	Чаша I	Чаша II		Сбивка угла на прессе		Сборка угла на штифтах	
				Чаша I	Чаша II	Чаша I	Чаша II
Соединение Т							
12-2132	20-1051/0817	20-1261/0817				40-DIN1481 A2 x2 D3x12 40-DIN916 A2 M5x6 HEX2,5	40-DIN1481 A2 x2 D5x12 42-DIN7504M A2 4,2x50 TX20



Сечение		Артикул Наименование	$I_x$ см <sup>4</sup> $I_y$ см <sup>4</sup>	$W_x$ см <sup>3</sup> $W_y$ см <sup>3</sup>	$S$ см <sup>2</sup> $P$ мм
		<p><b>12-2122</b> Рама 65 мм для створки-Т</p>			<p>0 0</p>

Профиль	Сухари		Химия	Комплектующие			
	Чаша I	Чаша II		Сбивка угла на прессе		Сборка угла на штифтах	
	Чаша I	Чаша II		Чаша I	Чаша II	Чаша I	Чаша II
Соединение L							
12-2122	20-0300/0059	20-0370/0296				40-DIN1481 A2 D5x12 x2	40-DIN1481 A2 D5x12 x2



Сечение				Артикул	$I_x$ см <sup>4</sup>	$W_x$ см <sup>3</sup>	$S$ см <sup>2</sup>
				Наименование	$I_y$ см <sup>4</sup>	$W_y$ см <sup>3</sup>	$P$ мм
				<p><b>12-2141</b> Рама створки-Т в витраж</p>	29,06	8,83	6,216
					27,17	6,29	470
				<p><b>12-2152</b> Рама в витраж</p>			0
							0
Профиль	Сухари		Химия	Комплекующие			
	Чаша I	Чаша II		Сбивка угла на прессе		Сборка угла на штифтах	
				Чаша I	Чаша II	Чаша I	Чаша II
Соединение L							
12-2141	20-0300/0059	20-0370/0296				40-DIN1481 A2 D5x12 x2	40-DIN1481 A2 D5x12 x2
12-2152	20-0130/0059	20-0130/0266		31-0010		40-DIN1481 A2 D5x12 x2 31-0010	40-DIN1481 A2 D5x12 x2



Сечение	Артикул Наименование	$I_x$ см <sup>4</sup>	$W_x$ см <sup>3</sup>	$S$ см <sup>2</sup>
		$I_y$ см <sup>4</sup>	$W_y$ см <sup>3</sup>	$P$ мм
	<b>12-2160</b> Рама 78 мм створки скрытой	$\frac{25,97}{15,23}$	$\frac{6,78}{2,88}$	$\frac{4,781}{427}$
	<b>12-2171</b> Порог 26 мм			$\frac{0}{0}$
	<b>12-2172</b> Порог 16 мм			$\frac{0}{0}$

Профиль	Сухари		Химия	Комплекующие			
	Чаша I	Чаша II		Сбивка угла на прессе		Сборка угла на штифтах	
				Чаша I	Чаша II	Чаша I	Чаша II
Соединение L							
12-2160	20-0200/0059	20-0200/0266		31-0010		40-DIN1481 A2 D5x12 x2 31-0010	40-DIN1481 A2 D5x12 x2
Соединение T							
12-2160	20-1051/0207	20-1261/0207				40-DIN1481 A2 D3x12 x2 40-DIN916 A2 M5x6 HEX2,5	40-DIN1481 A2 D5x12 x2 42-DIN7504M A2 4,2x50 TX20
12-2171		32-1864					43-DIN7982C A2 3,9x16 TX15 x4
12-2172	32-1864					43-DIN7982C A2 3,9x16 TX15 x2	43-DIN7982C A2 3,9x16 TX15 x2





Сечение	Артикул Наименование	$I_x$ см <sup>4</sup>	$W_x$ см <sup>3</sup>	$S$ см <sup>2</sup>
		$I_y$ см <sup>4</sup>	$W_y$ см <sup>3</sup>	$P$ мм
	<p><b>12-2210</b> Импост 84 мм</p>	$\frac{26,85}{15,51}$	$\frac{7,16}{3,69}$	$\frac{5,242}{452}$

Профиль	Сухари		Химия	Комплекующие					
	Чаша I	Чаша II		Сбивка угла на прессе		Сборка угла на штифтах			
				Чаша I	Чаша II	Чаша I	Чаша II		
Соединение L									
12-2210	20-0200/0059	20-0200/0266		31-0010	x2	40-DIN1481 A2 D5x12	x2	40-DIN1481 A2 D5x12	x2
						31-0010	x2		
Соединение T									
12-2210	20-1051/0207	20-1261/0207				40-DIN1481 A2 D3x12	x2	40-DIN1481 A2 D5x12	x2
						40-DIN916 A2 M5x6 HEX2,5		42-DIN7504M A2 4,2x50 TX20	



Сечение	Артикул Наименование	$I_x$ см <sup>4</sup>	$W_x$ см <sup>3</sup>	$S$ см <sup>2</sup>
		$I_y$ см <sup>4</sup>	$W_y$ см <sup>3</sup>	$P$ мм
	<p><b>12-2220</b> Импост 84 мм усиленный</p>	<p>94,58 21,25</p>	<p>16,25 5,06</p>	<p>8,092 550</p>

Профиль	Сухари		Химия	Комплекующие			
	Чаша I	Чаша II		Сбивка угла на прессе		Сборка угла на штифтах	
Соединение			Чаша I	Чаша II	Чаша I	Чаша II	
12-2220	20-0200/0059	20-0200/0266		31-0010	x2	40-DIN1481 A2 D5x12 x2 31-0010 x2	40-DIN1481 A2 D5x12 x2
Соединение T							
12-2220	20-1051/0207	20-1261/0207				40-DIN1481 A2 D3x12 x2 40-DIN916 A2 M5x6 HEX2,5	40-DIN1481 A2 D5x12 x2 42-DIN7504M A2 4,2x50 TX20



Сечение	Артикул Наименование	$I_x$ см <sup>4</sup>	$W_x$ см <sup>3</sup>	$S$ см <sup>2</sup>
		$I_y$ см <sup>4</sup>	$W_y$ см <sup>3</sup>	$P$ мм
	<p><b>12-2221</b> Импост 84 мм усиленный</p>	<p>121,35 21,28</p>	<p>19,32 5,07</p>	<p>8,128 551</p>

Профиль	Сухари		Химия	Комплекующие			
	Чаша I	Чаша II		Сбивка угла на прессе		Сборка угла на штифтах	
			Чаша I	Чаша II	Чаша I	Чаша II	
Соединение L							
12-2221	20-0200/0059	20-0200/0266		31-0010 x2		40-DIN1481 A2 D5x12 x2 31-0010 x2	40-DIN1481 A2 D5x12 x2
Соединение T							
12-2221	20-1051/0207	20-1261/0207				40-DIN1481 A2 D3x12 x2 40-DIN916 A2 M5x6 HEX2,5	40-DIN1481 A2 D5x12 x2 42-DIN7504M A2 4,2x50 TX20



Сечение	Артикул Наименование	$I_x$ см <sup>4</sup>	$W_x$ см <sup>3</sup>	$S$ см <sup>2</sup>
		$I_y$ см <sup>4</sup>	$W_y$ см <sup>3</sup>	$P$ мм
	<p><b>12-2230</b> Импост 70 мм в створку-Z</p>	$33,80$ $8,94$	$8,03$ $2,55$	$5,012$ $428$

Профиль	Сухари		Химия	Комплекующие			
	Чаша I	Чаша II		Сбивка угла на прессе		Сборка угла на штифтах	
			Чаша I	Чаша II	Чаша I	Чаша II	
Соединение L							
12-2230	20-0130/0059	20-0130/0266		31-0010 x2		40-DIN1481 A2 D5x12 x2 31-0010 x2	40-DIN1481 A2 D5x12 x2
Соединение T							
12-2230	20-1051/0127	20-1261/0127				40-DIN1481 A2 D3x8 x2 40-DIN916 A2 M5x6 HEX2,5	40-DIN1481 A2 D5x8 x2 42-DIN7504M A2 4,2x50 TX20



Сечение	Артикул Наименование	$I_x$ см <sup>4</sup>	$W_x$ см <sup>3</sup>	$S$ см <sup>2</sup>
		$I_y$ см <sup>4</sup>	$W_y$ см <sup>3</sup>	$P$ мм
	<b>12-2260</b> Импост 100 мм створки скрытой	32,86	8,05	5,606
		23,82	4,19	486

Профиль	Сухари		Химия	Комплектующие			
	Чаша I	Чаша II		Сбивка угла на прессе		Сборка угла на штифтах	
				Чаша I	Чаша II	Чаша I	Чаша II
Соединение L							
12-2260	20-0200/0059	20-0200/0266		31-0010 x2		40-DIN1481 A2 D5x12 x2 31-0010 x2	40-DIN1481 A2 D5x12 x2
Соединение T							
12-2260	20-1051/0207	20-1261/0207				40-DIN1481 A2 D3x12 x2 40-DIN916 A2 M5x6 HEX2,5	40-DIN1481 A2 D5x12 x2 42-DIN7504M A2 4,2x50 TX20



Сечение	Артикул Наименование	$I_x$ см <sup>4</sup>	$W_x$ см <sup>3</sup>	$S$ см <sup>2</sup>
		$I_y$ см <sup>4</sup>	$W_y$ см <sup>3</sup>	$P$ мм
<p><b>12-2310</b> Створка-Z 73 мм</p>				0 0
<p><b>12-2320</b> Створка-Z 98 мм</p>				0 0

Профиль	Сухари		Химия	Комплекующие			
	Чаша I	Чаша II		Сбивка угла на прессе		Сборка угла на штифтах	
				Чаша I	Чаша II	Чаша I	Чаша II
Соединение L							
12-2310	20-0130/0059	20-0200/0315		31-0010	31-0010	40-DIN1481 A2 D5x12 x2 31-0010	40-DIN1481 A2 D5x12 x2 31-0010
12-2320	20-0370/0059	20-0440/0314		31-0010	31-0010	40-DIN1481 A2 D5x12 x2 31-0010	40-DIN1481 A2 D5x12 x2 31-0010



Сечение				Артикул	$I_x$ см <sup>4</sup>	$W_x$ см <sup>3</sup>	$S$ см <sup>2</sup>
				Наименование	$I_y$ см <sup>4</sup>	$W_y$ см <sup>3</sup>	$P$ мм
				<p><b>12-2332</b> Створка-Т 100 мм</p>			<p>0 0</p>

Профиль	Сухари		Химия	Комплектующие			
	Чаша I	Чаша II		Сбивка угла на прессе		Сборка угла на штифтах	
				Чаша I	Чаша II	Чаша I	Чаша II
Соединение L							
12-2332	20-0440/0279	20-0370/0100		31-0010	x2	40-DIN1481 A2 D5x12	x2
						31-0010	x2
						40-DIN1481 A2 D5x12	x2



Сечение	Артикул Наименование	$I_x$ см <sup>4</sup> $I_y$ см <sup>4</sup>	$W_x$ см <sup>3</sup> $W_y$ см <sup>3</sup>	$S$ см <sup>2</sup> $P$ мм
	<b>12-2341</b> Створка-T 94 мм			0 0
	<b>12-2360</b> Створка-Z 65 мм скрытая			0 0

Профиль	Сухари		Химия	Комплекующие			
	Чаша I	Чаша II		Сбивка угла на прессе		Сборка угла на штифтах	
				Чаша I	Чаша II	Чаша I	Чаша II
Соединение L							
12-2341	20-0440/0061	20-0440/0211		31-0010		40-DIN1481 A2 D5x12 x2 31-0010	40-DIN1481 A2 D5x12 x2
12-2360	20-0060/0059	20-0130/0311 20-0130/0074*			31-0010	40-DIN1481 A2 D3x8 x2	40-DIN1481 A2 D5x12 x2 31-0010





Сечение	Артикул Наименование	$I_x$ см <sup>4</sup> $I_y$ см <sup>4</sup>	$W_x$ см <sup>3</sup> $W_y$ см <sup>3</sup>	$S$ см <sup>2</sup> $P$ мм
	<p><b>12-2410</b> Штульп 69 мм</p>			<p>0 0</p>
	<p><b>12-2421</b> Штульп 46 мм дверной</p>			<p>0 0</p>
	<p><b>12-2431</b> Профиль оборачивающий створки-Т</p>			<p>0 0</p>

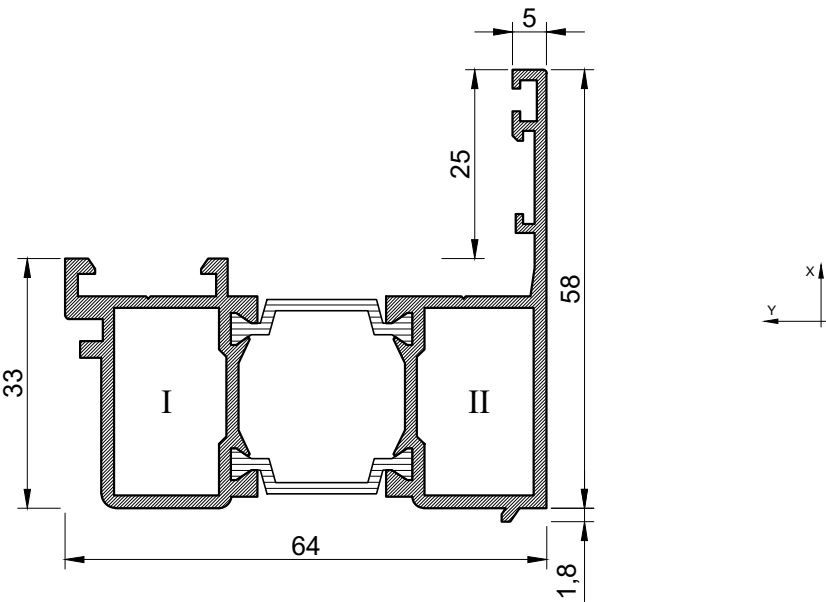

Сечение	Артикул Наименование	$I_x$ см <sup>4</sup> $I_y$ см <sup>4</sup>	$W_x$ см <sup>3</sup> $W_y$ см <sup>3</sup>	$S$ см <sup>2</sup> $P$ мм
	<p><b>12-2440</b> Профиль оборачивающий</p>			<p>0 0</p>

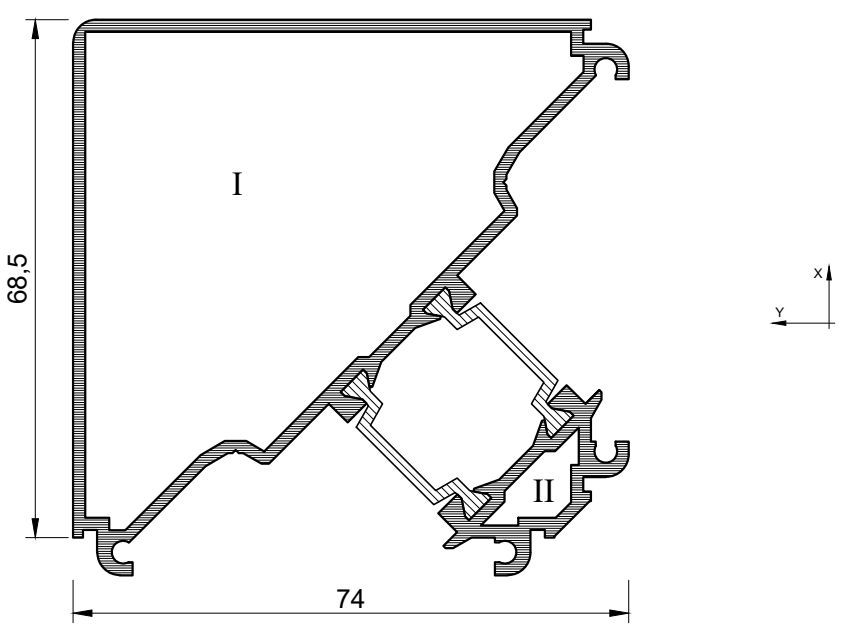

Сечение	Артикул Наименование	$I_x$ см <sup>4</sup> $I_y$ см <sup>4</sup>	$W_x$ см <sup>3</sup> $W_y$ см <sup>3</sup>	$S$ см <sup>2</sup> $P$ мм
	<p><b>12-2510</b> Угол 90 градусов</p>			<p>0 0</p>

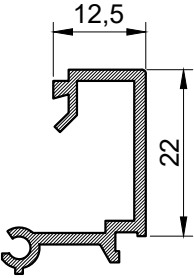
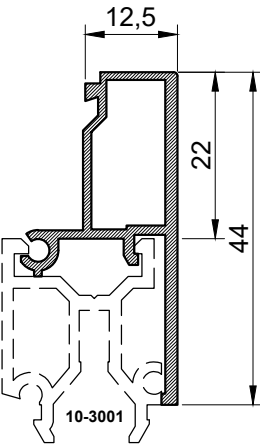
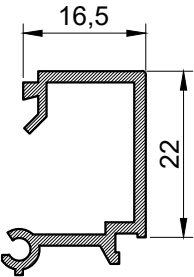
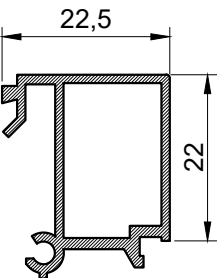
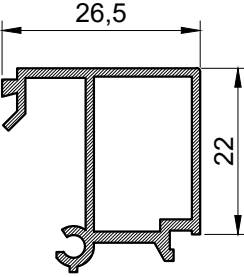

Сечение	Артикул Наименование	$I_x$ см <sup>4</sup> $I_y$ см <sup>4</sup>	$W_x$ см <sup>3</sup> $W_y$ см <sup>3</sup>	$S$ см <sup>2</sup> $P$ мм
	<p><b>10-3120</b> Штапик 12,5 мм x 22 мм</p>			<p>0,96 134</p>
	<p><b>10-3121</b> Штапик 12,5 мм x 22 мм с крылом</p>			<p>0 0</p>
	<p><b>10-3160</b> Штапик 16,5 мм x 22 мм</p>			<p>1,018 142</p>
	<p><b>10-3220</b> Штапик 22,5 мм x 22 мм</p>			<p>1,15 130</p>
	<p><b>10-3260</b> Штапик 26,5 мм x 22 мм</p>			<p>1,2 133</p>

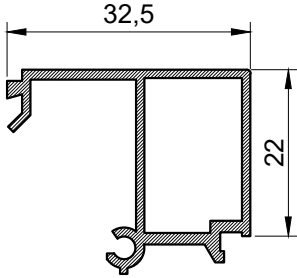
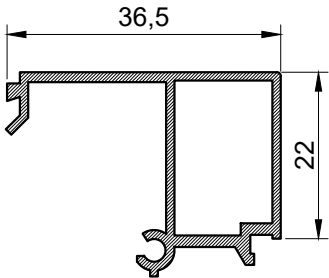
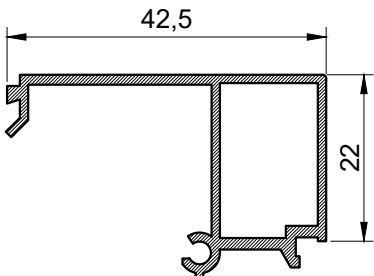
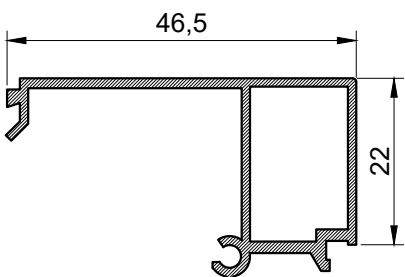

Сечение	Артикул Наименование	$I_x$ см <sup>4</sup> $I_y$ см <sup>4</sup>	$W_x$ см <sup>3</sup> $W_y$ см <sup>3</sup>	$S$ см <sup>2</sup> $P$ мм
	<p><b>10-3320</b> Штапик 32,5 мм x 22 мм</p>			<p>1,21 150</p>
	<p><b>10-3360</b> Штапик 36,5 мм x 22 мм</p>			<p>1,33 153</p>
	<p><b>10-3420</b> Штапик 42,5 мм x 22 мм</p>			<p>1,347 236</p>
	<p><b>10-3460</b> Штапик 46,5 мм x 22 мм</p>			<p>0 0</p>

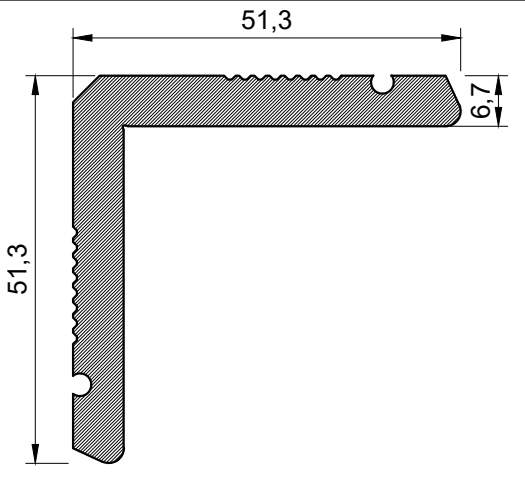
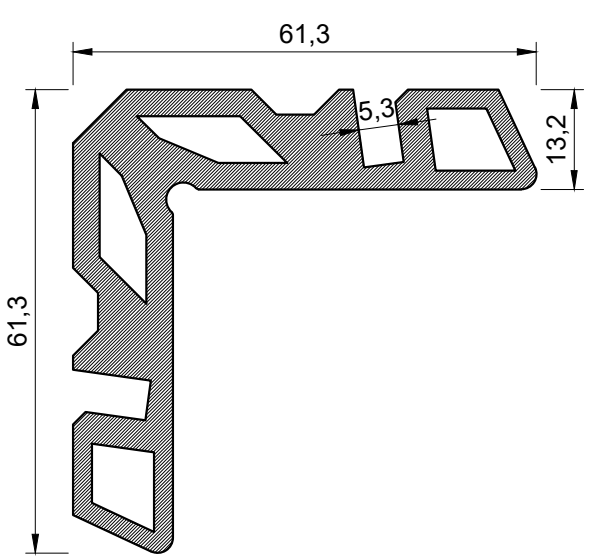
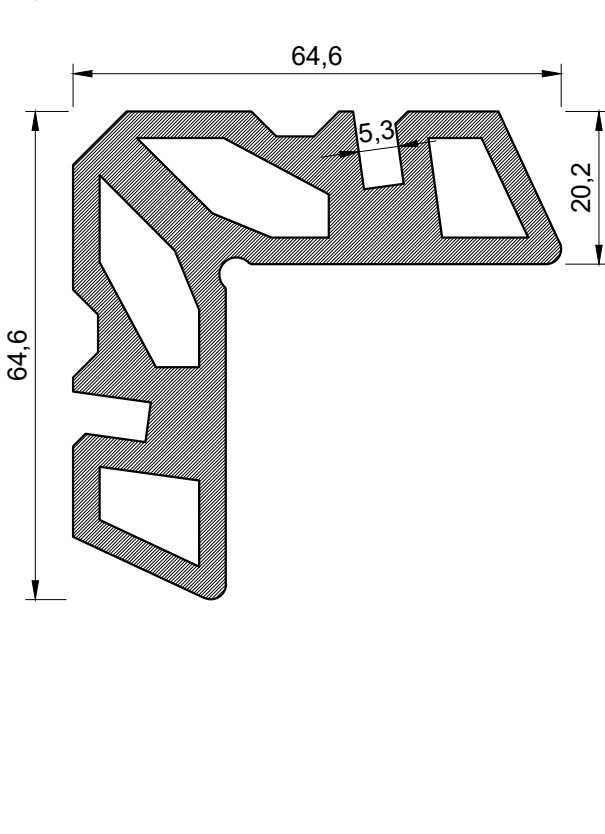

Сечение	Артикул Наименование	$I_x$ см <sup>4</sup> $I_y$ см <sup>4</sup>	$W_x$ см <sup>3</sup> $W_y$ см <sup>3</sup>	$S$ см <sup>2</sup> $P$ мм
	<p><b>10-0060</b> Сухарь 6,7 мм</p>			<p>0 0</p>
	<p><b>10-0130</b> Сухарь 13,2 мм</p>			<p>89,9 271</p>
	<p><b>10-0200</b> Сухарь 20,2 мм</p>			<p>125 279</p>



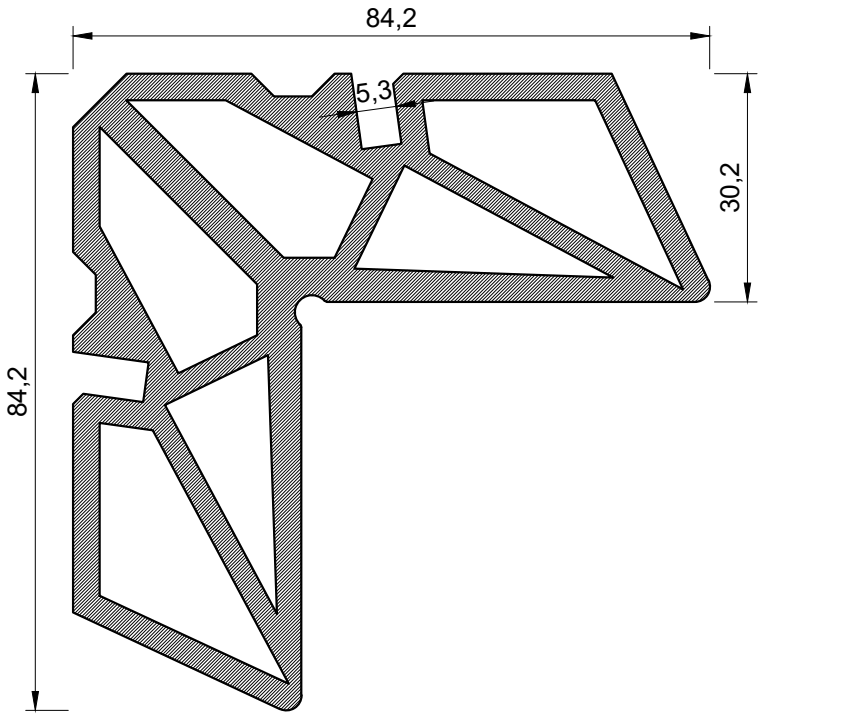
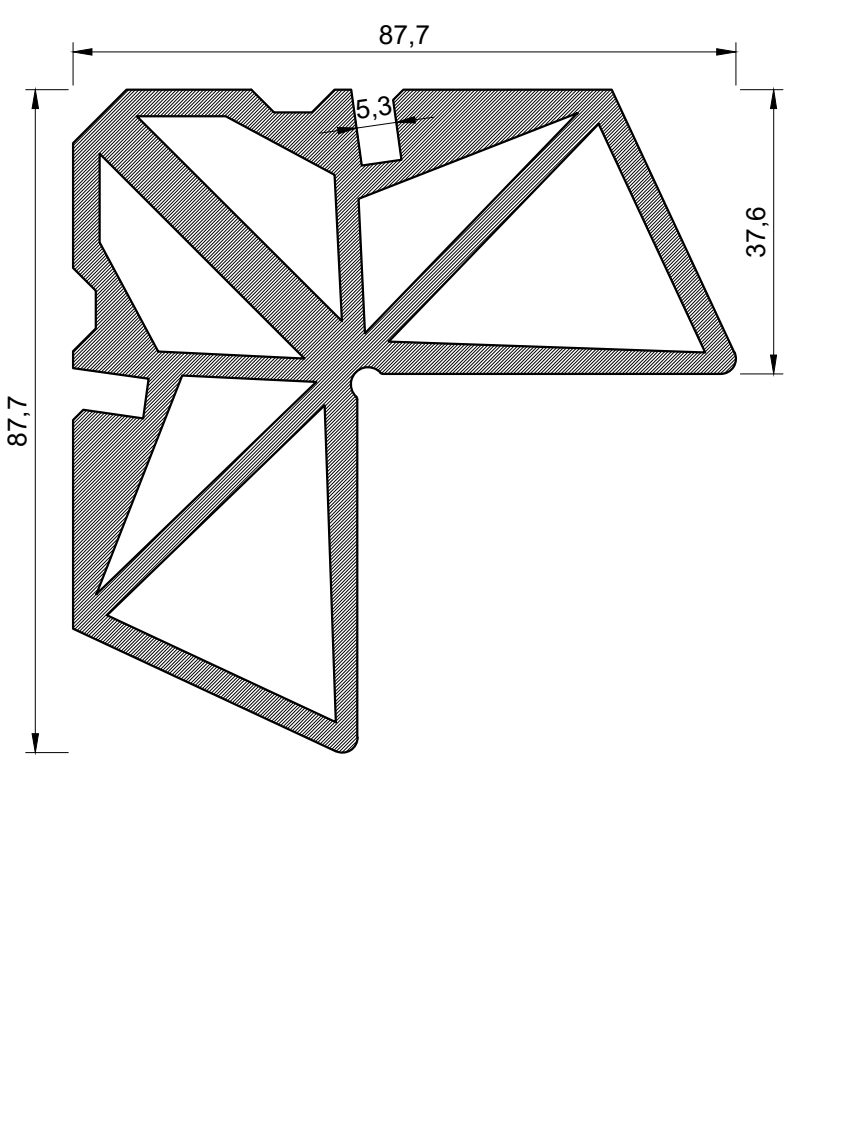

Сечение	Артикул Наименование	$I_x$ см <sup>4</sup> $I_y$ см <sup>4</sup>	$W_x$ см <sup>3</sup> $W_y$ см <sup>3</sup>	$S$ см <sup>2</sup> $P$ мм
	<p><b>10-0300</b> Сухарь 30,2 мм</p>			<p>0 0</p>
	<p><b>10-0370</b> Сухарь 37,6 мм</p>			<p>208 358</p>

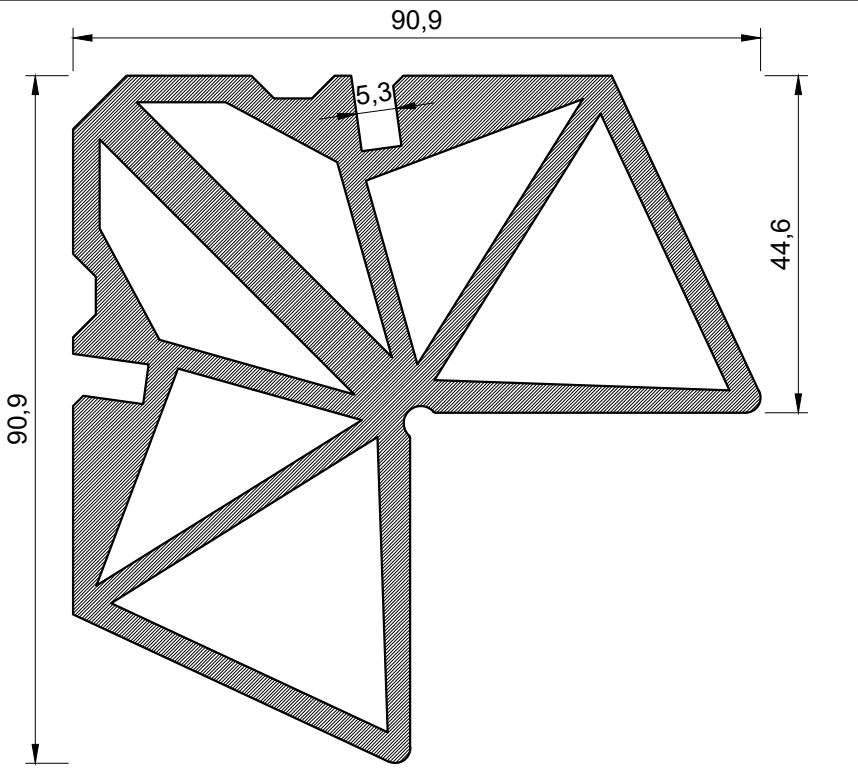

Сечение	Артикул Наименование	$I_x$ см <sup>4</sup> $I_y$ см <sup>4</sup>	$W_x$ см <sup>3</sup> $W_y$ см <sup>3</sup>	$S$ см <sup>2</sup> $P$ мм
	<p><b>10-0440</b> Сухарь 44,6 мм</p>			<p>224 366</p>



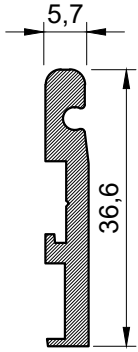
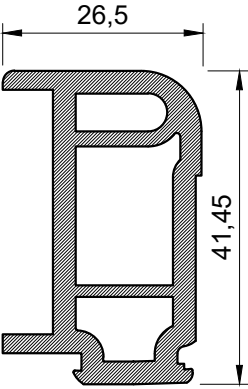
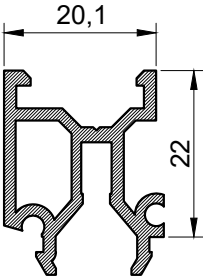
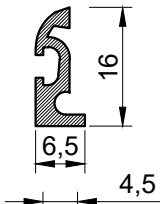

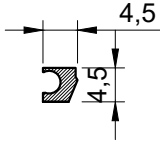
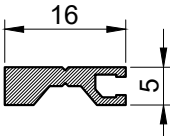
Сечение	Артикул Наименование	$I_x$ см <sup>4</sup> $I_y$ см <sup>4</sup>	$W_x$ см <sup>3</sup> $W_y$ см <sup>3</sup>	$S$ см <sup>2</sup> $P$ мм
	<p><b>10-1051</b> Сухарь 5,7 мм крепления импоста</p>			<p>1,3987 97</p>
	<p><b>10-1261</b> Сухарь 26 мм крепления импоста</p>			<p>4,0032 147</p>
	<p><b>10-3001</b> Адаптер штапика с крылом</p>			<p>0 0</p>
	<p><b>10-4040</b> Штапик наружный створки скрытой</p>			<p>0 0</p>
	<p><b>10-5060</b> Профиль стыковочный</p>			<p>2,9 35</p>
	<p><b>10-5050</b> Профиль крепления мембраны</p>			<p>1,4 22</p>
	<p><b>10-5201</b> Профиль для уплотнителя порога</p>			<p>--- ---</p>



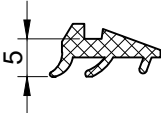
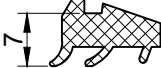
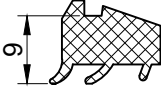
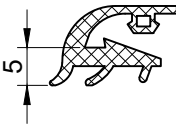
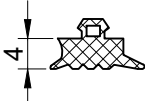
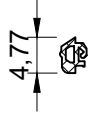
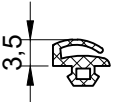
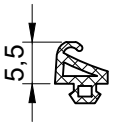
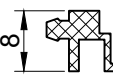
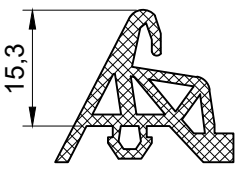



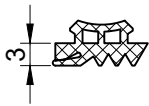
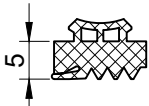
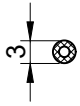
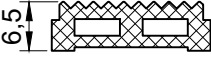
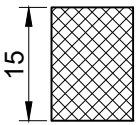
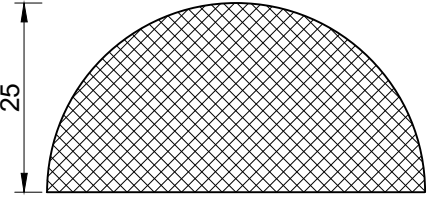



















Сечение	Ед. Изм.	Н.У.	Артикул Наименование
	пог. м	250	<b>50-1250</b> Уплотнитель под штапик 5 мм
	пог. м	200	<b>50-1270</b> Уплотнитель под штапик 7 мм
	пог. м	200	<b>50-1290</b> Уплотнитель под штапик 9 мм
	пог. м	300	<b>50-1450</b> Уплотнитель под штапик 5 мм створки скрытой
	пог. м	300	<b>50-2040</b> Уплотнитель под СП 4 мм
	пог. м	400	<b>50-3001</b> Уплотнитель притвора 0,5 мм
	пог. м	400	<b>50-3030</b> Уплотнитель притвора 3,5 мм
	пог. м	400	<b>50-3051</b> Уплотнитель притвора 5,5 мм
	пог. м	320	<b>50-3060</b> Уплотнитель притвора 6 мм
	пог. м	35	<b>50-4220</b> Уплотнитель центральный WD64











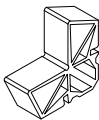

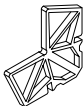

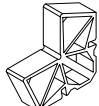

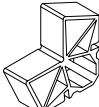

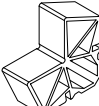





Сечение	Ед. Изм.	Н.У.	Артикул Наименование
	пог. м	210	<b>50-5030</b> Уплотнитель внутренний 3 мм
	пог. м	160	<b>50-5050</b> Уплотнитель внутренний 5 мм
	пог. м	500	<b>50-7010</b> Уплотнитель круглый Д3 мм
	пог. м	200	<b>51-2002</b> Заглушка порога
	пог. м	25	<b>52-2001</b> ПСУЛ 15x5 мм
	пог. м	50	<b>52-5501</b> Уплотнитель вспененный Д50/2 мм













Сечение	Внешний вид	Ед. Изм.	Н.У.	Артикул Наименование
		шт.	20	<b>20-0060/0059</b> Сухарь 6,7 мм х5,9 мм
		шт.	20	<b>20-0130/0059</b> Сухарь 13,2 мм х5,9 мм
		шт.	20	<b>20-0130/0074</b> Сухарь 13,2 мм х7,4 мм
		шт.	10	<b>20-0130/0266</b> Сухарь 13,2 мм х26,6 мм
		шт.	10	<b>20-0130/0311</b> Сухарь 13,2 мм х31,1 мм
		шт.	20	<b>20-0200/0059</b> Сухарь 20,2 мм х5,9 мм
		шт.	10	<b>20-0200/0266</b> Сухарь 20,2 мм х26,6 мм
		шт.	10	<b>20-0200/0315</b> Сухарь 20,2 мм х31,5 мм
		шт.	20	<b>20-0300/0059</b> Сухарь 30,2 мм х5,9 мм
		шт.	10	<b>20-0300/0266</b> Сухарь 30,0 мм х26,6 мм
		шт.	20	<b>20-0370/0059</b> Сухарь 37,6 мм х5,9 мм
		шт.	20	<b>20-0370/0100</b> Сухарь 37,6 мм х10,0 мм

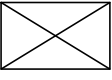



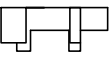
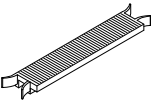
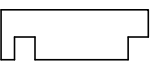
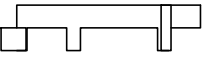
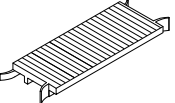
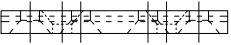
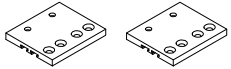
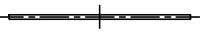
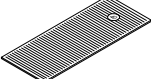

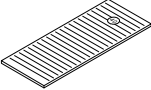
Сечение	Внешний вид	Ед. Изм.	Н.У.	Артикул Наименование
		шт.	10	<b>20-0370/0296</b> Сухарь 37,6 мм х29,6 мм
		шт.	20	<b>20-0440/0061</b> Сухарь 44,6 мм х6,1 мм
		шт.	10	<b>20-0440/0211</b> Сухарь 44,6 мм х21,1 мм
		шт.	10	<b>20-0440/0279</b> Сухарь 44,6 мм х27,9 мм
		шт.	10	<b>20-0440/0314</b> Сухарь 44,6 мм х31,4 мм
		шт.	50	<b>20-1051/0127</b> Сухарь 5,7 мм х12,7 мм
		шт.	50	<b>20-1051/0207</b> Сухарь 5,7 мм х20,7 мм
		шт.	50	<b>20-1051/0307</b> Сухарь 5,7 мм х30,7 мм
		шт.	1	<b>20-1051/0817</b> Сухарь 5,7 мм х81,7 мм
		шт.	50	<b>20-1261/0127</b> Сухарь 26,0 мм х12,7 мм
		шт.	50	<b>20-1261/0207</b> Сухарь 26,0 мм х20,7 мм
		шт.	40	<b>20-1261/0307</b> Сухарь 26,0 мм х30,7 мм

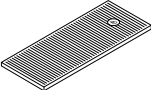
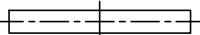
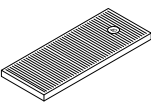



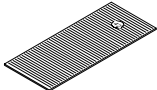

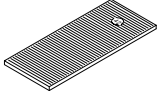
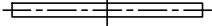
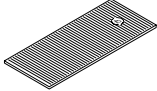
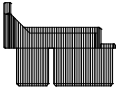
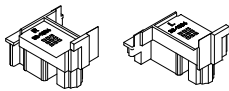
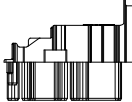
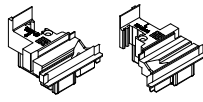

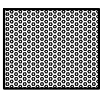













Сечение	Внешний вид	Ед. Изм.	Н.У.	Артикул Наименование
		шт.	50	<b>31-0010</b> Уголок выравнивающий
		шт.	10	<b>32-0003</b> Опора СП 22x36 мм
		шт.	10	<b>32-0020</b> Крышка дренажная оконная
		шт.	10	<b>32-1510</b> Заглушка Д10 мм
		шт.	1	<b>32-1620</b> Опора СП 20 мм
		шт.	1	<b>32-1632</b> Опора СП 32 мм
		шт.	1	<b>32-1640</b> Опора СП 40 мм
		пара.	1	<b>32-1864</b> Комплект креплений порога WD64
		шт.	100	<b>32-6401</b> Пластина рихтовочная 40x1 мм
		шт.	100	<b>32-6402</b> Пластина рихтовочная 40x2 мм
		шт.	100	<b>32-6403</b> Пластина рихтовочная 40x3 мм
		шт.	100	<b>32-6405</b> Пластина рихтовочная 40x5 мм



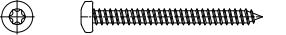

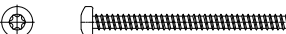
Сечение	Внешний вид	Ед. Изм.	Н.У.	Артикул Наименование
		шт.	100	<b>32-6421</b> Пластина рихтовочная 42x1 мм
		шт.	100	<b>32-6422</b> Пластина рихтовочная 42x2 мм
		шт.	100	<b>32-6423</b> Пластина рихтовочная 42x3 мм
		компл.	1	<b>33-1964</b> Комплект заглушек штульповых дверных WD64
		компл.	1	<b>33-2064</b> Комплект заглушек штульповых оконных WD64
		пог. м	6,5	<b>65-1001</b> Профиль базы
		пог. м	1,2	<b>65-1004</b> Trioterm 35x42 мм

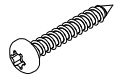



Сечение	Внешний вид	Ед. Изм.	Н.У.	Артикул Наименование
		шт.	100	<b>40-DIN916 A2</b> <b>M5x6 HEX2,5</b> Винт установочный с кантом
		шт.		<b>40-DIN1481 A2</b> <b>D3x8</b> Штифт
		шт.		<b>40-DIN1481 A2</b> <b>D3x12</b> Штифт
		шт.		<b>40-DIN1481 A2</b> <b>D5x8</b> Штифт
		шт.		<b>40-DIN1481 A2</b> <b>D5x12</b> Штифт
		шт.		<b>41-DIN7981C A2</b> <b>3,9x50 TX15</b> Шуруп с полукруглой головкой
		шт.	200	<b>41-DIN7981C A2</b> <b>4,2x45 TX20</b> Шуруп с полукруглой головкой
		шт.	200	<b>41-DIN7981C A2</b> <b>4,2x60 TX20</b> Шуруп с полукруглой головкой
		шт.	500	<b>41-DIN7981C A2</b> <b>4,8x32 TX25</b> Шуруп с полукруглой головкой
		шт.	1000	<b>43-DIN7982C A2</b> <b>3,9x16 TX15</b> Шуруп с потайной головкой

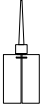
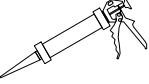

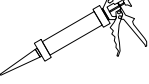
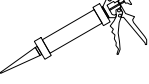
Сечение	Внешний вид	Ед. Изм.	Н.У.	Артикул Наименование
		шт.	1	<b>80-2002</b> Клей двухкомпонентный Cosmofen DUO
		шт.	1	<b>80-3002</b> Клей-герметик полиуретановый черный COSMO HD-100.412
		шт.	1	<b>80-4001</b> Очиститель Cosmofen 60
		шт.	1	<b>80-6002</b> Клей гибридный полимерный blaugelb Power Fix
		шт.	1	<b>80-9001</b> Клей-герметик для ЭПДМ SikaBond TF Plus N



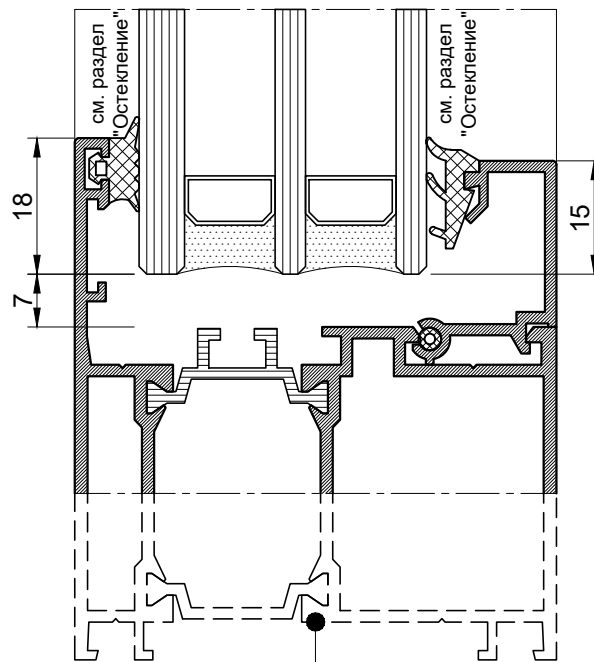
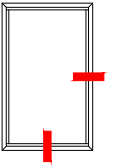

12-2110

12-2130

12-2152

12-2210

12-2220

12-2221

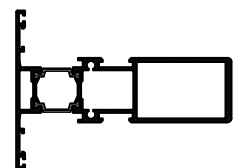
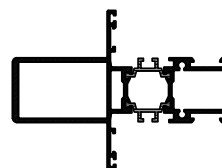
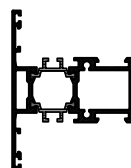
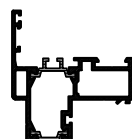
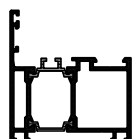
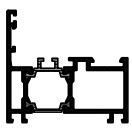

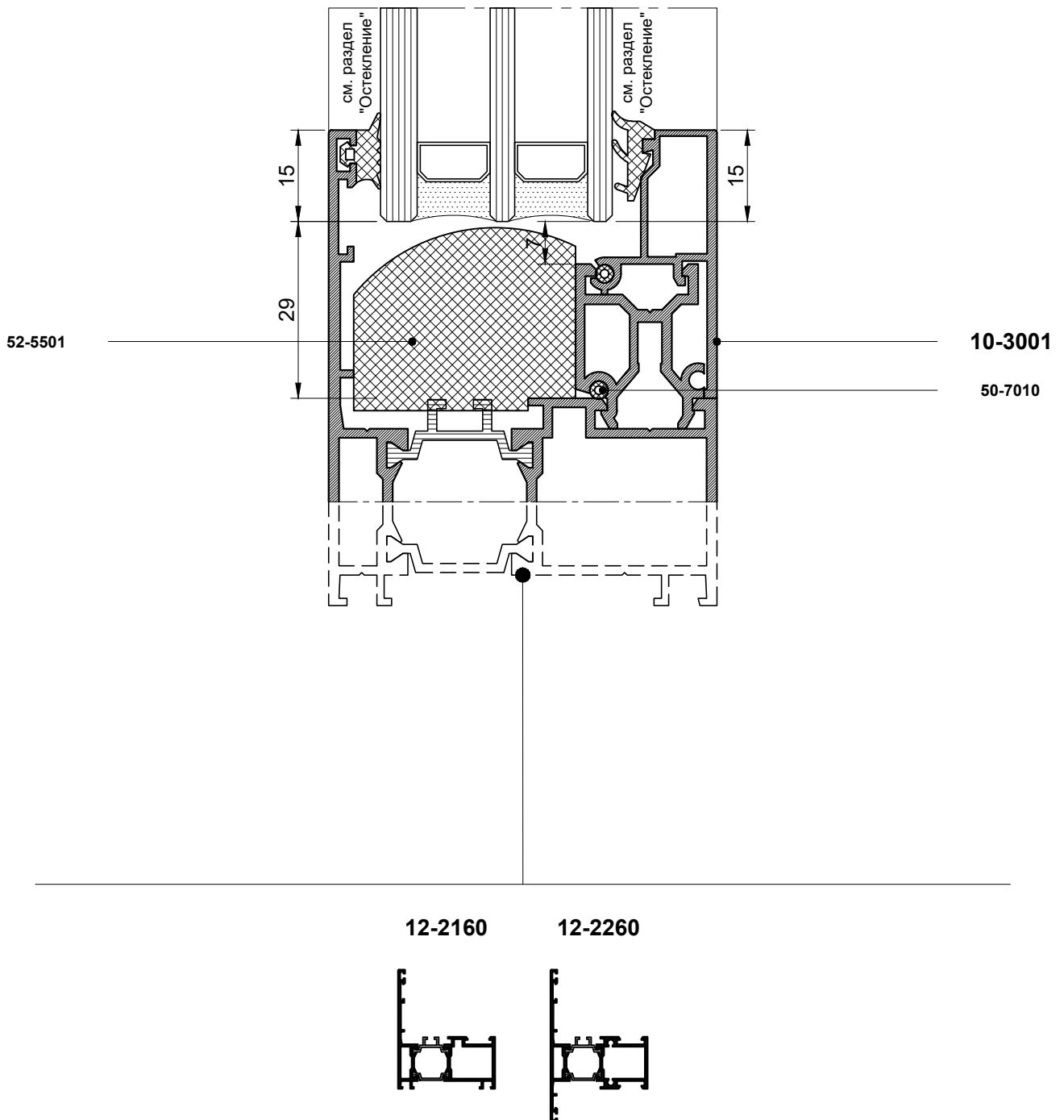
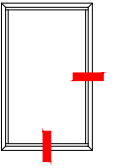

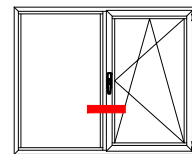

12-2260

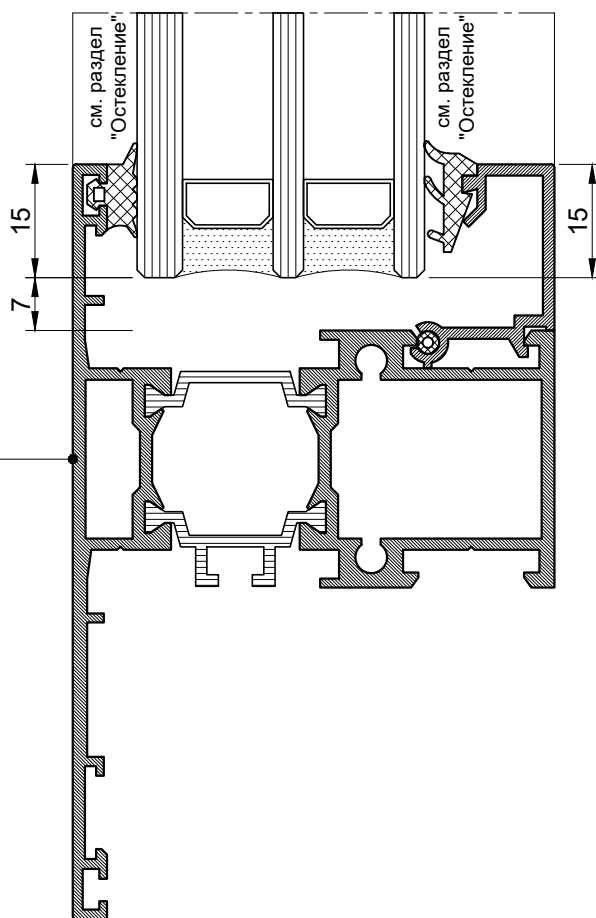

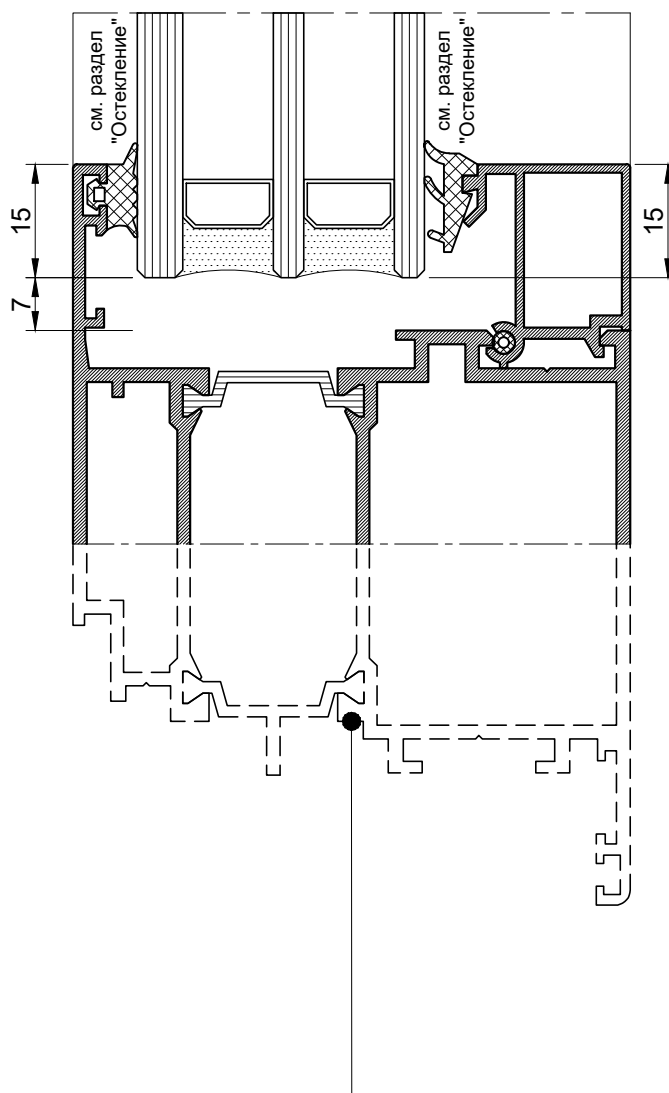
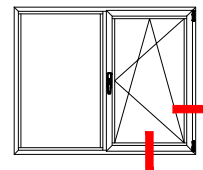

12-2310

12-2320

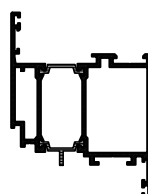
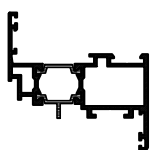

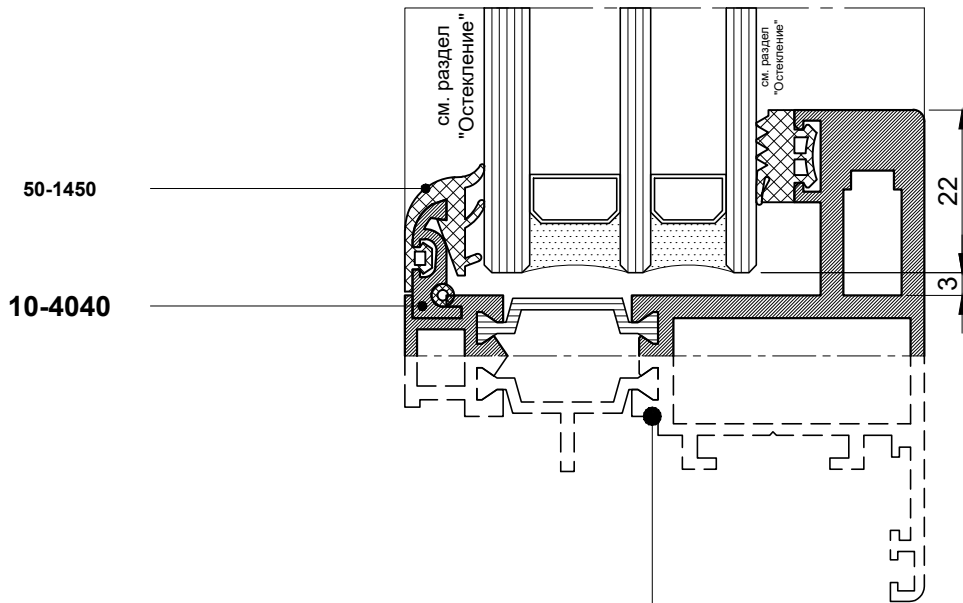
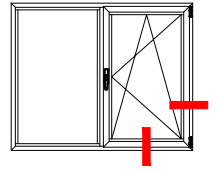

12-2360

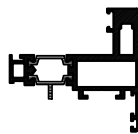

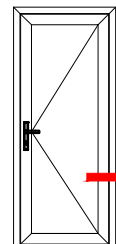

12-2341

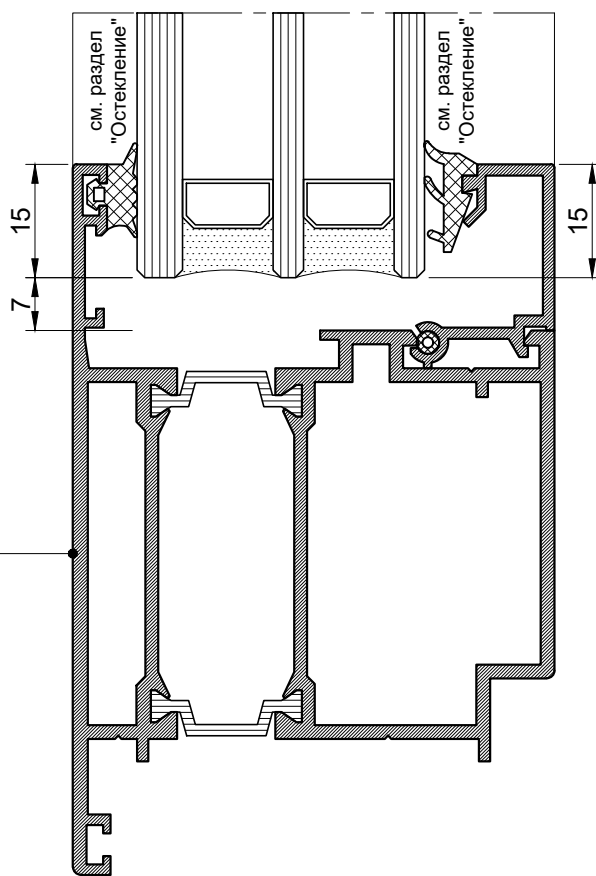



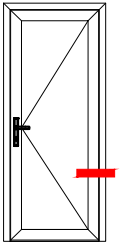

12-2332

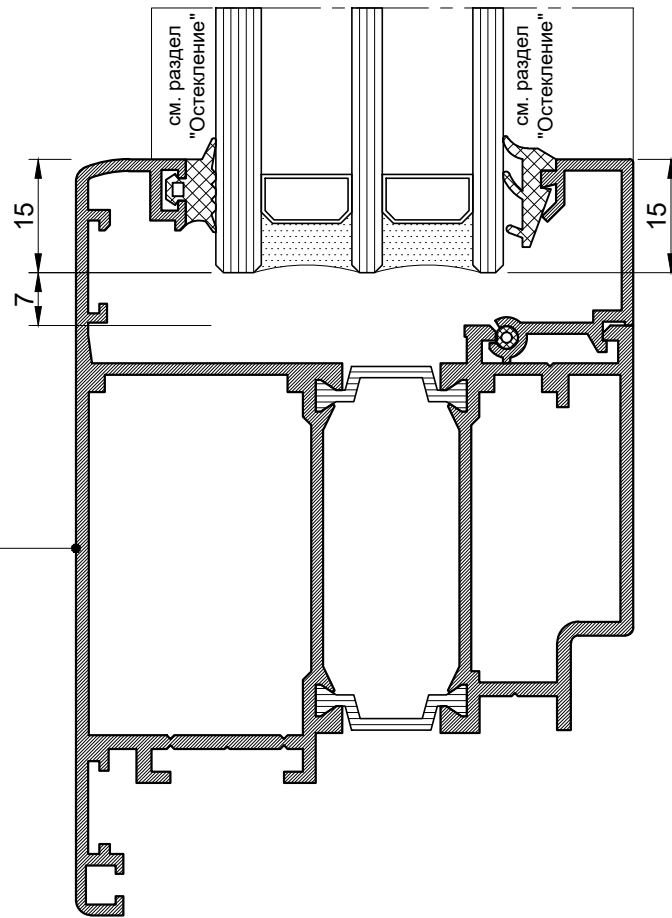

12-2310

12-2320

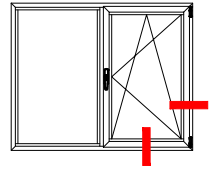
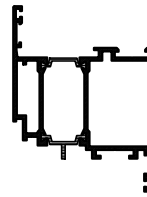
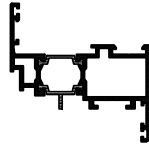

50-3001  
(опция)

50-4220

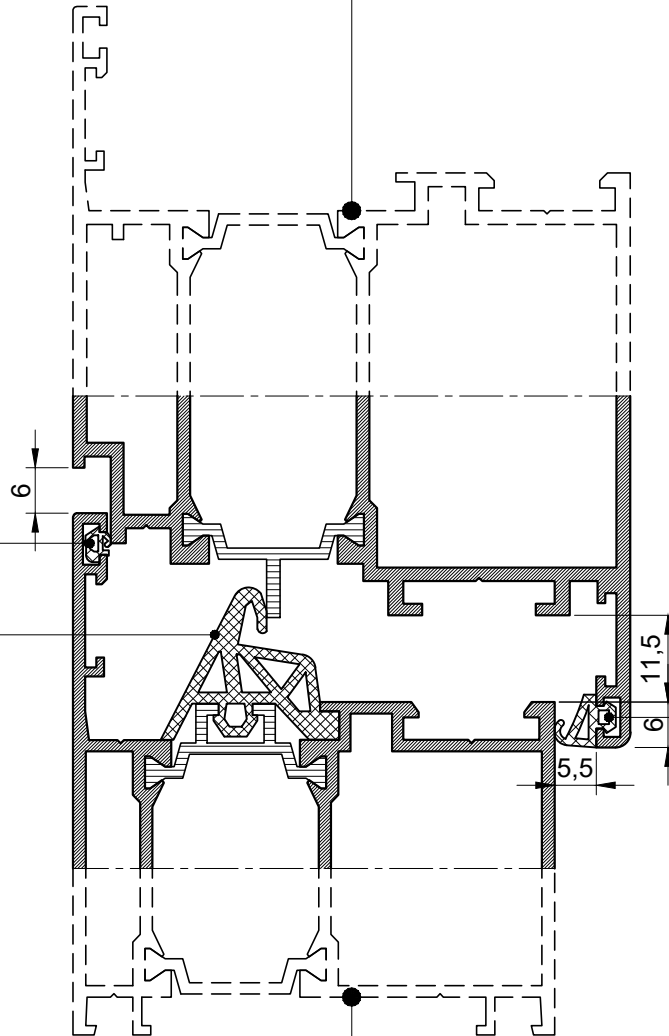

50-3051

12-2110

12-2130

12-2152

12-2210

12-2220

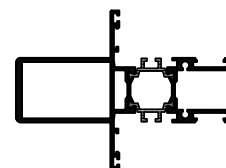
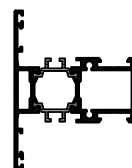
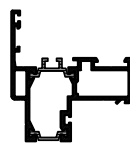
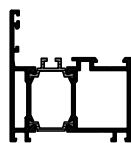
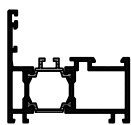

12-2360

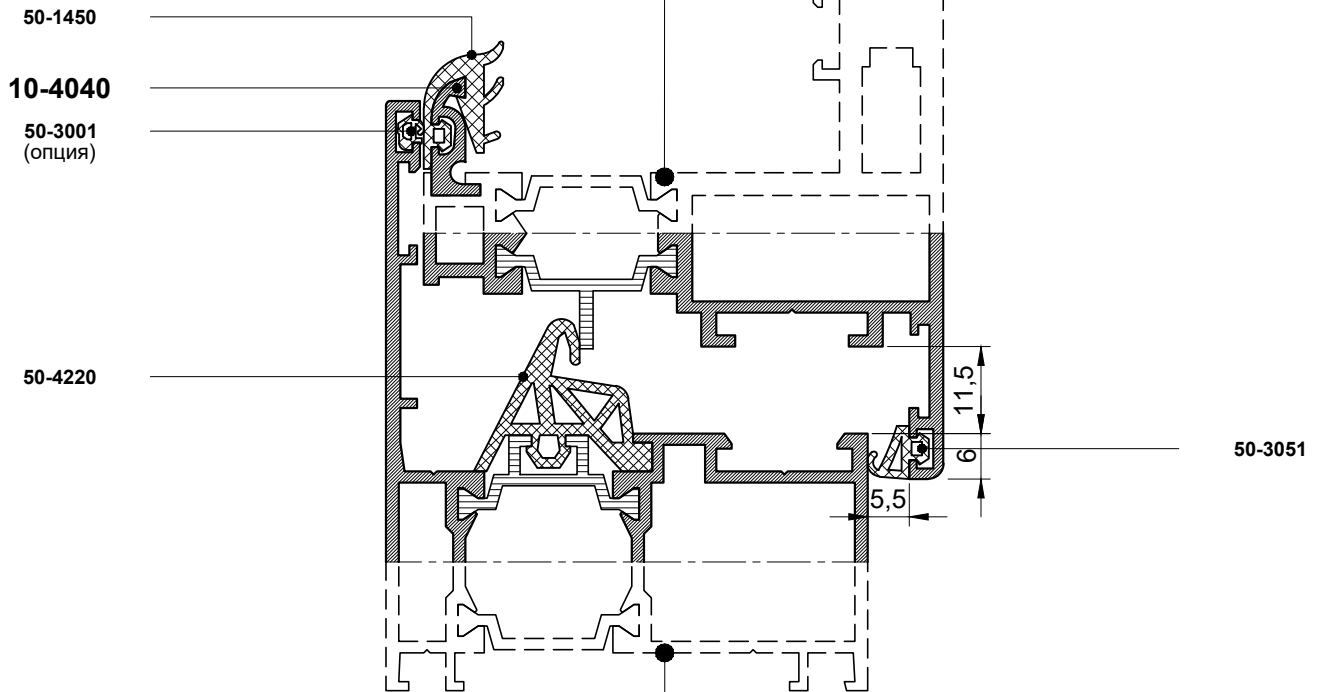
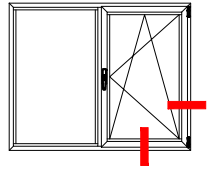
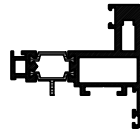

12-2160

12-2260

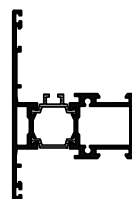
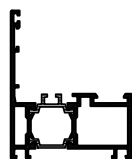

12-2310

12-2320

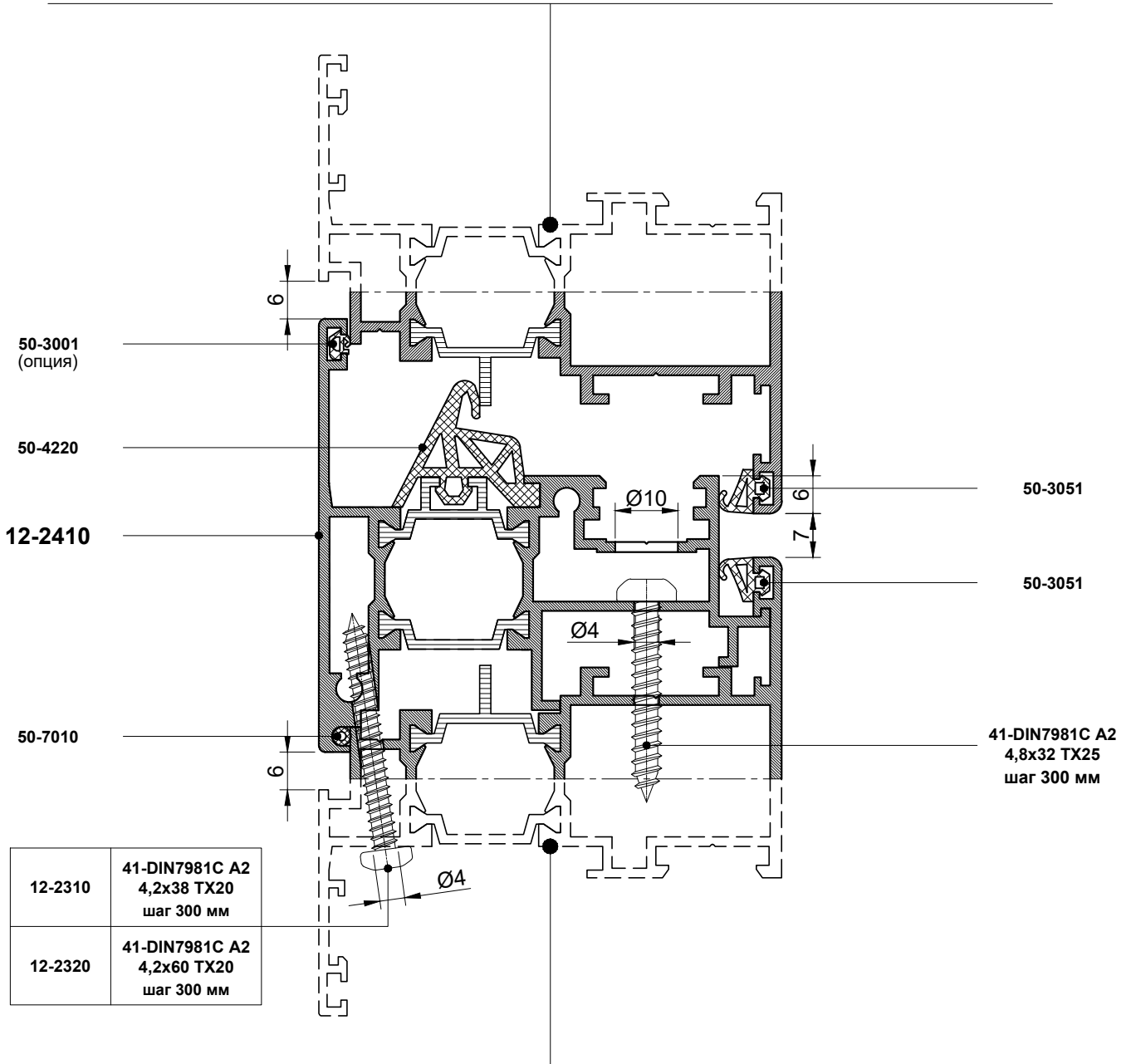
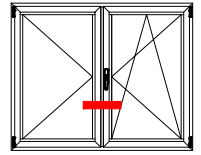
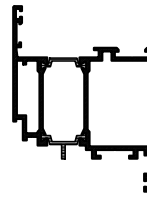
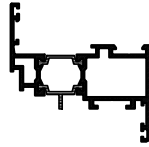

12-2310

12-2320

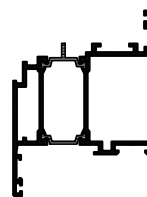
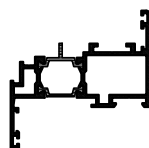

12-2110

12-2130

12-2122

12-2160

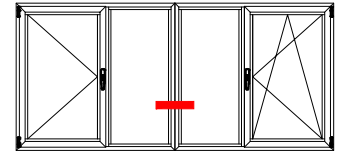
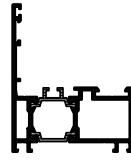
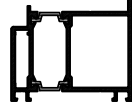
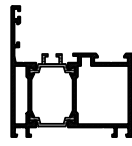
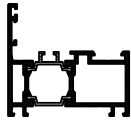

52-2001  
10-5060  
50-7010

10-5060  
50-7010

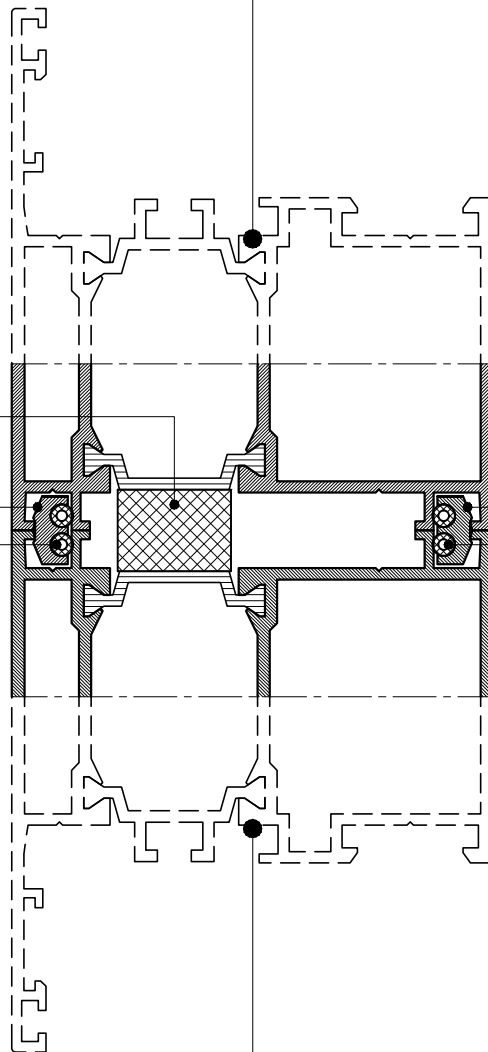

12-2110

12-2130

12-2122

12-2160

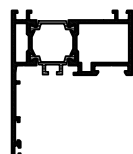
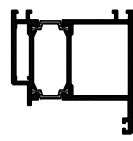
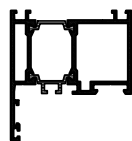
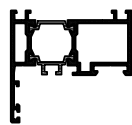

12-2110

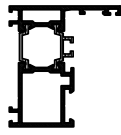

12-2130

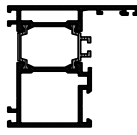

12-2122

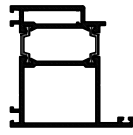

12-2160

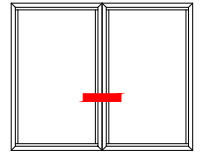
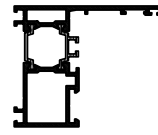

12-2510

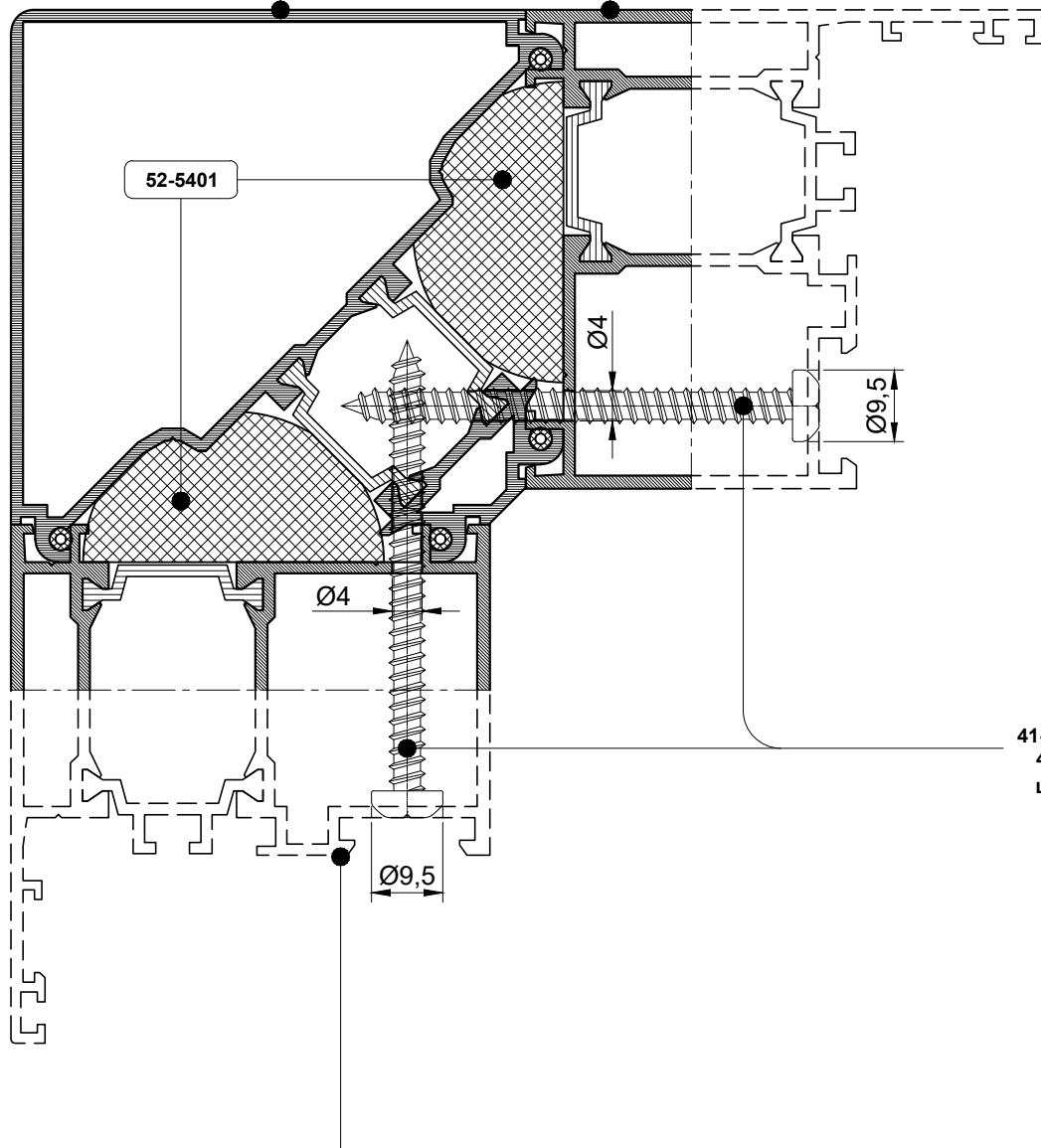

41-DIN7981C A2  
4,8x60 TX25  
шаг 300 мм

12-2110

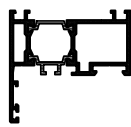

12-2130

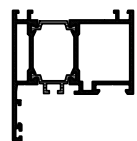

12-2122

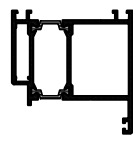

12-2160

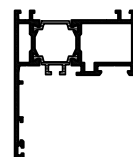

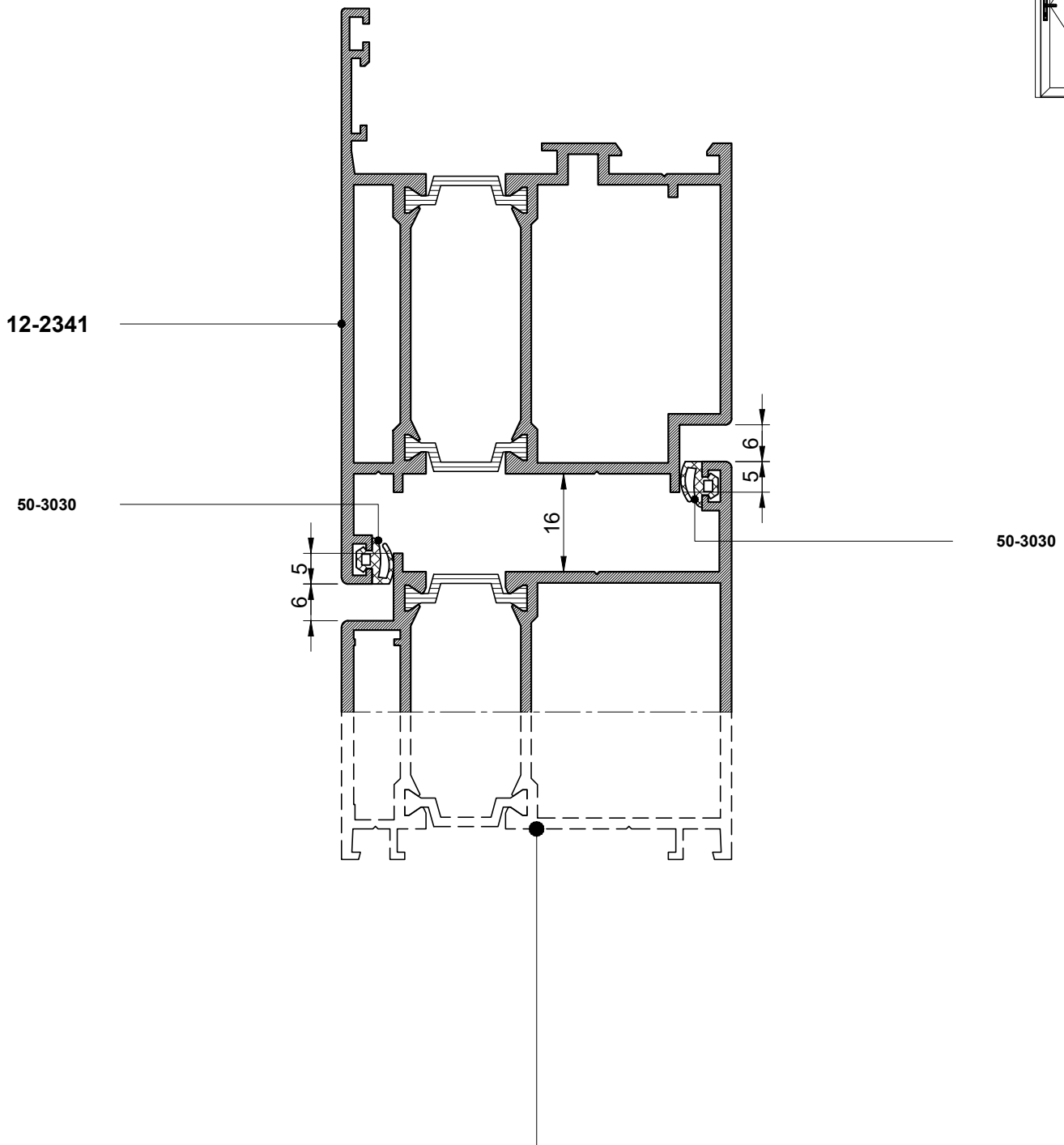
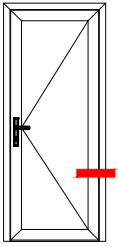

12-2122

12-2141

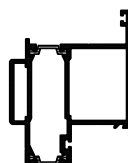
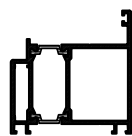

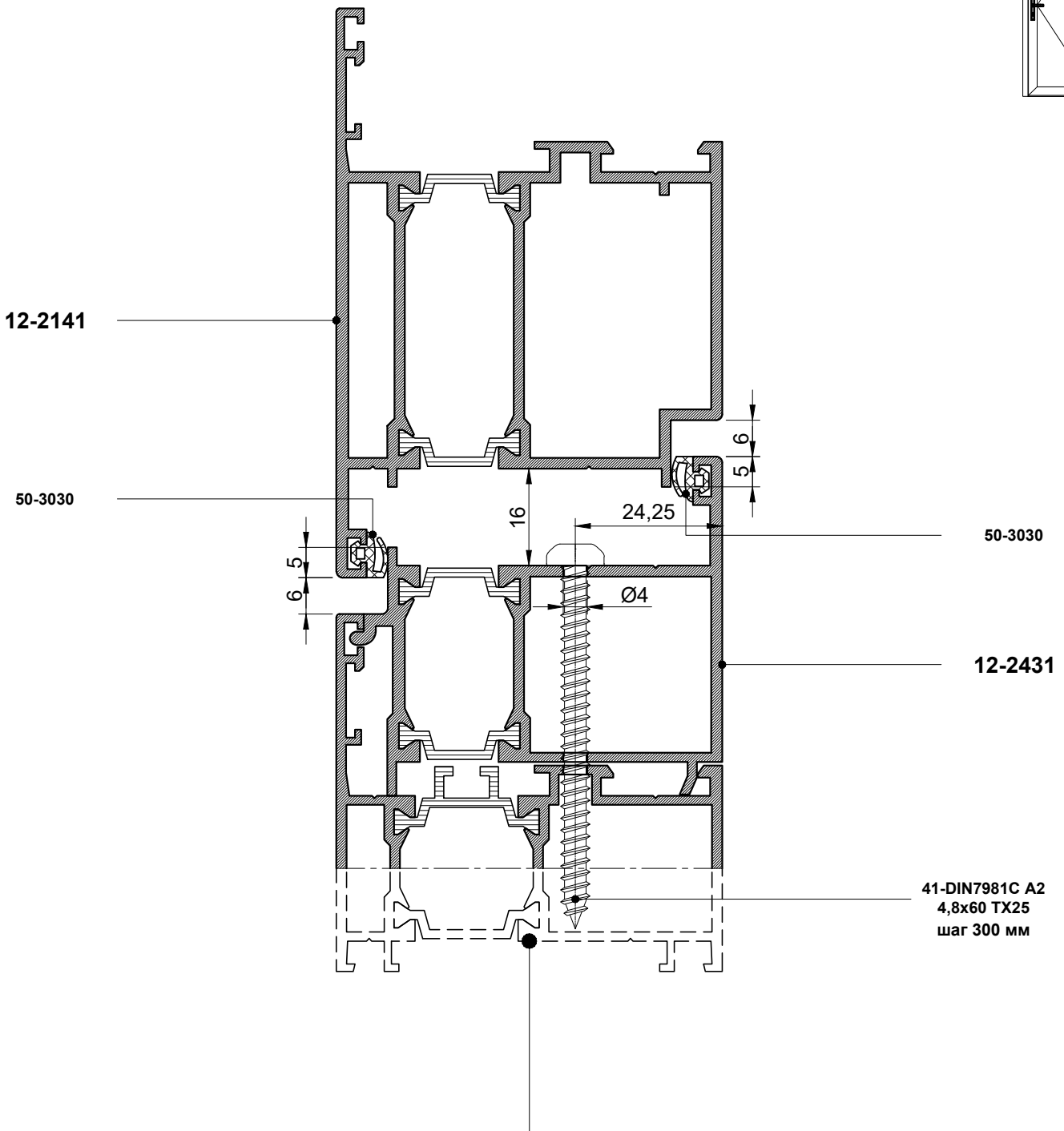
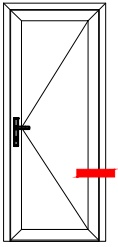

12-2110

12-2130

12-2152

12-2210

12-2221

12-2220

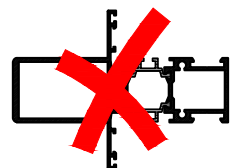
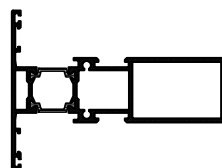
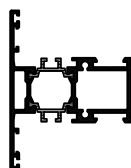
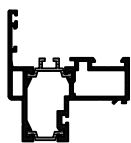
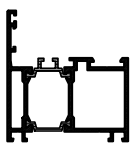
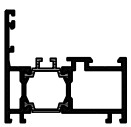



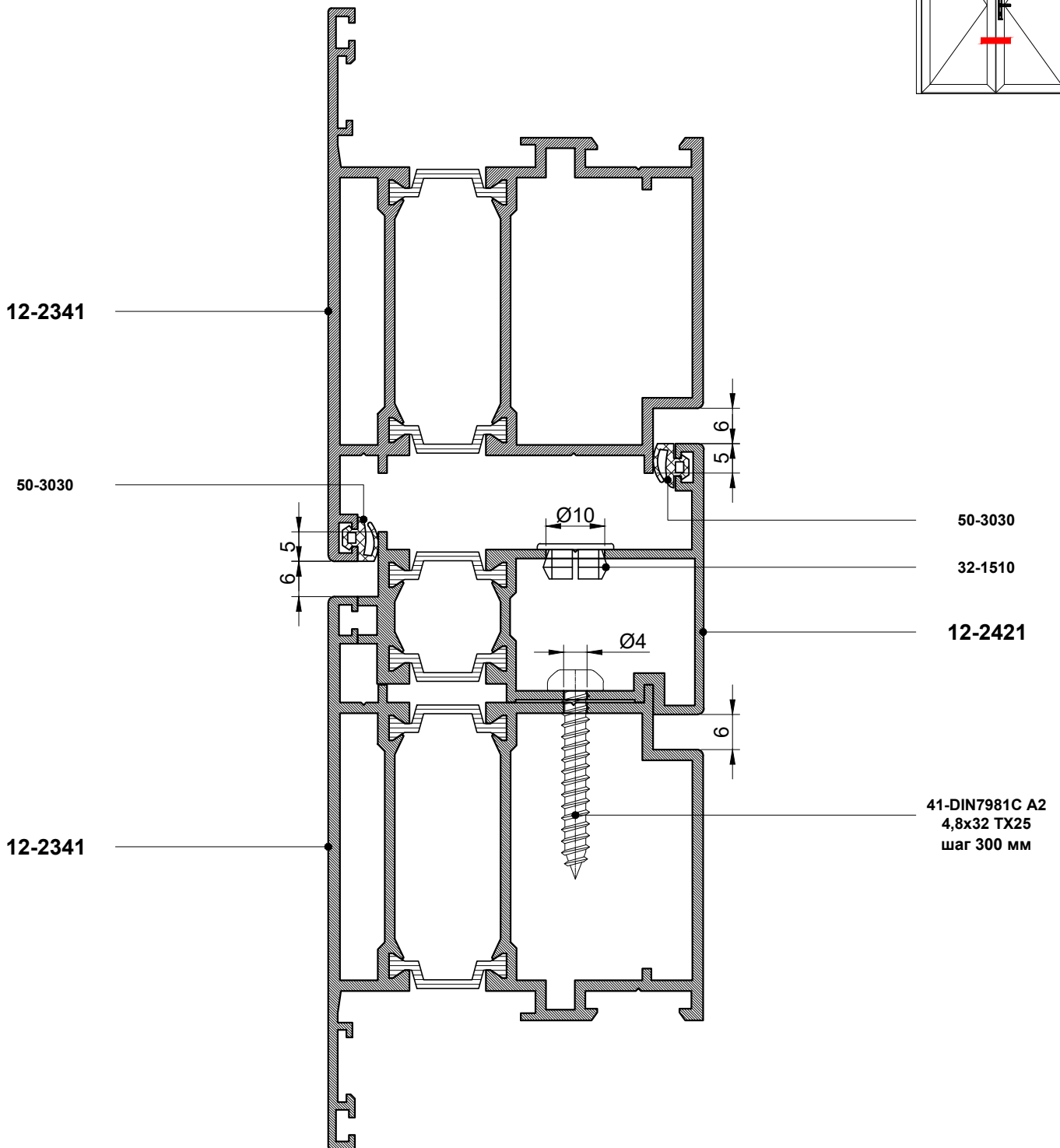
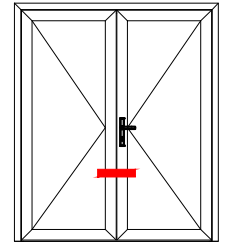

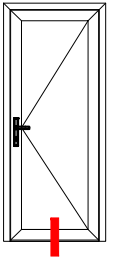

12-2341

50-3030

12-2172

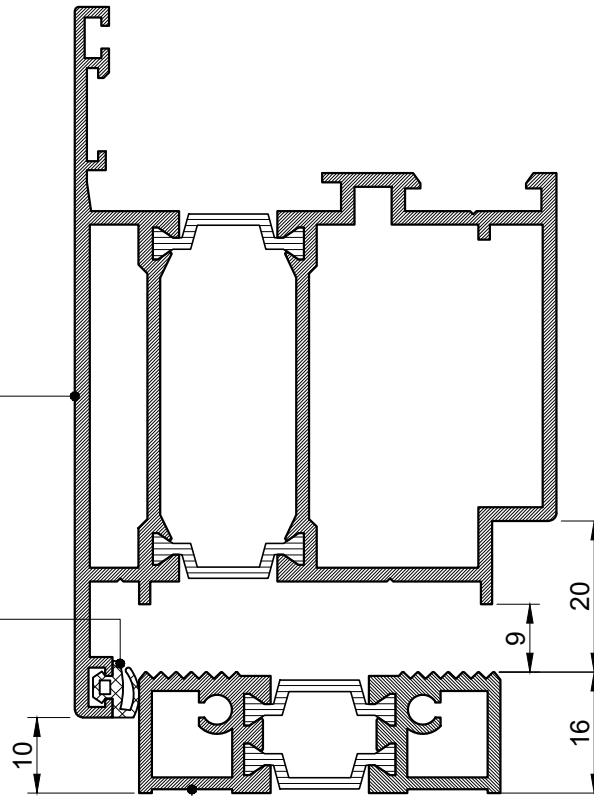

12-2341

50-3030

12-2171

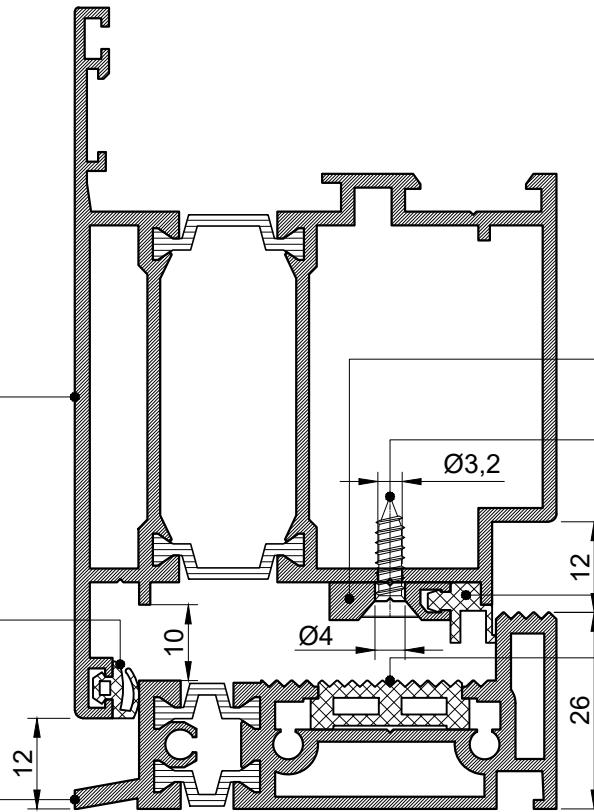

10-5201

43-DIN7982C A2  
3,9x16 TX15  
шаг 200 мм

50-3060

51-2002



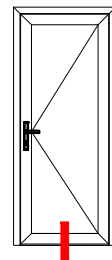

12-2341

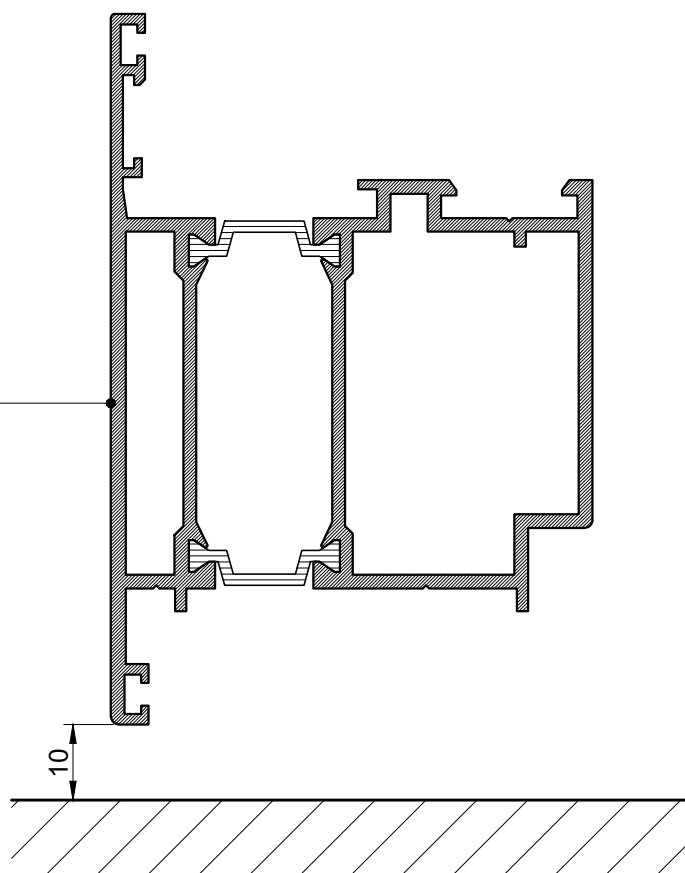

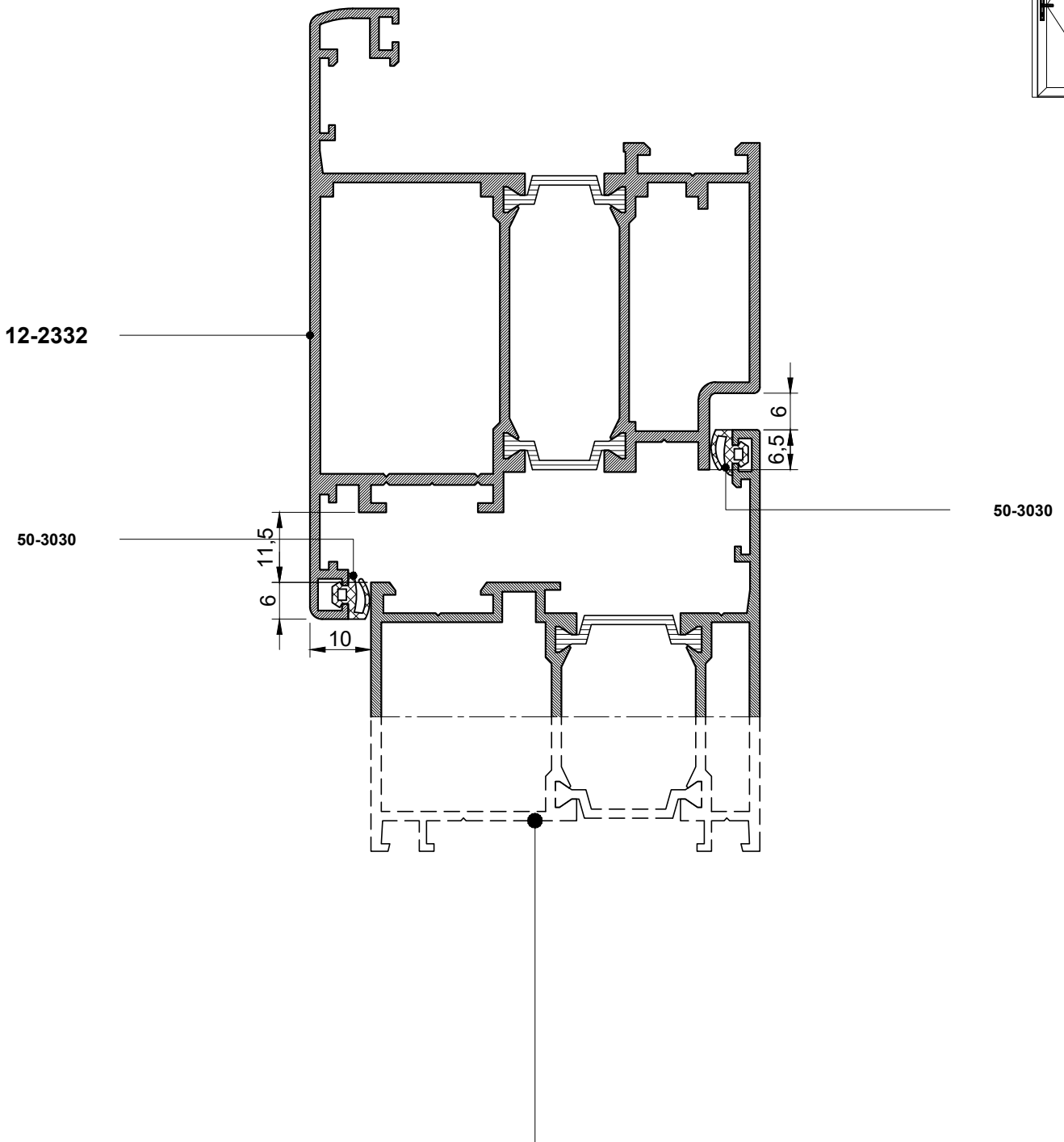
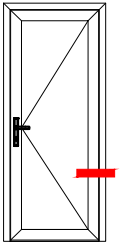

12-2111

12-2131

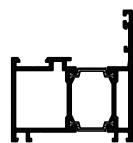
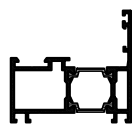

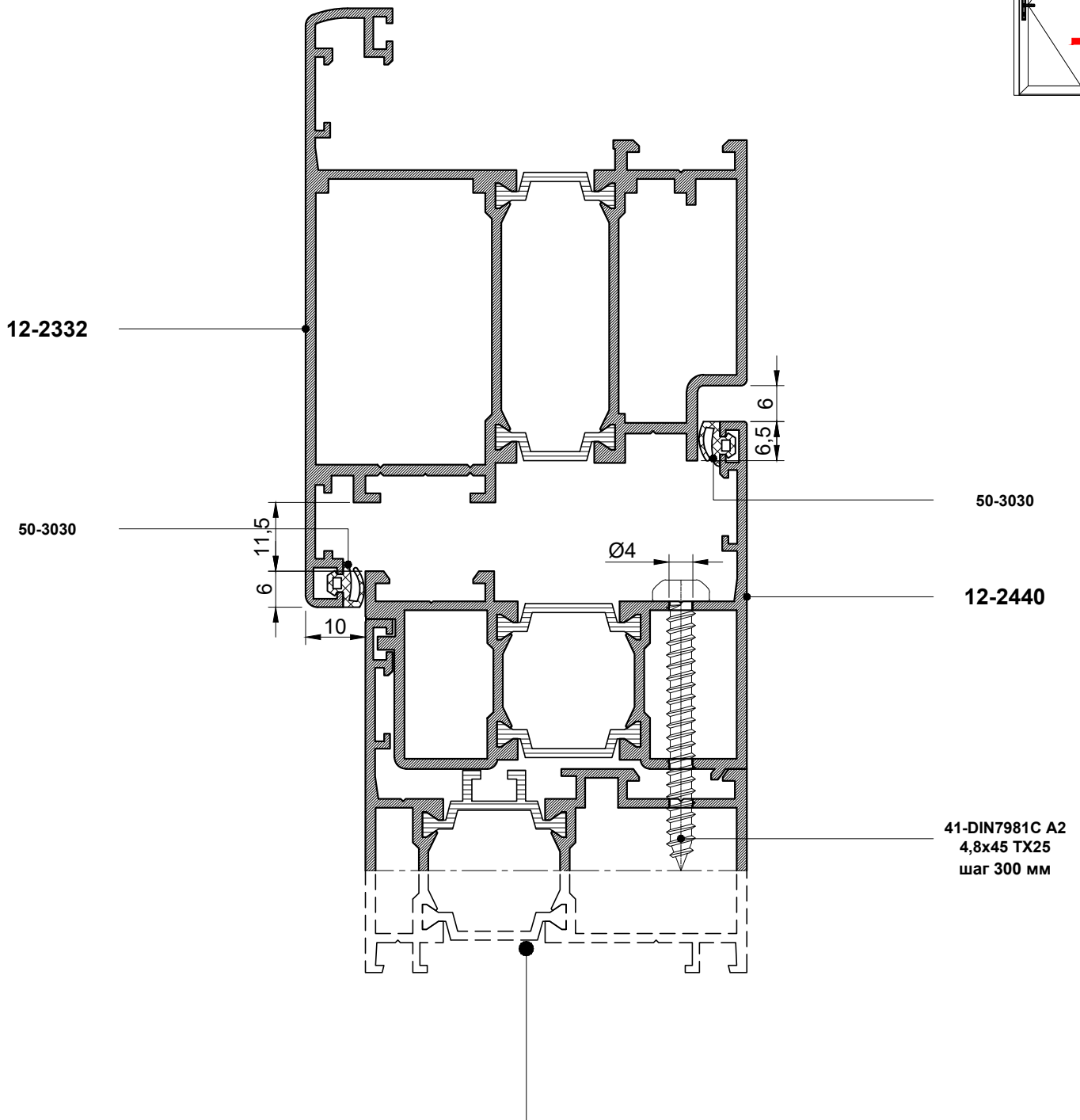
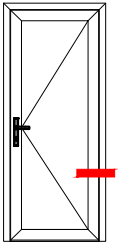

12-2110

12-2130

12-2152

12-2210

12-2221

12-2220

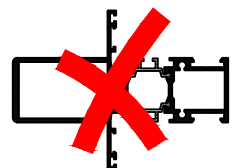
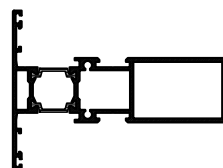
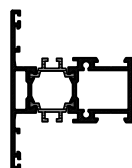
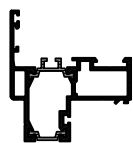
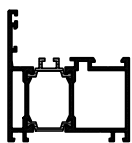
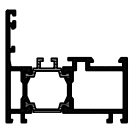

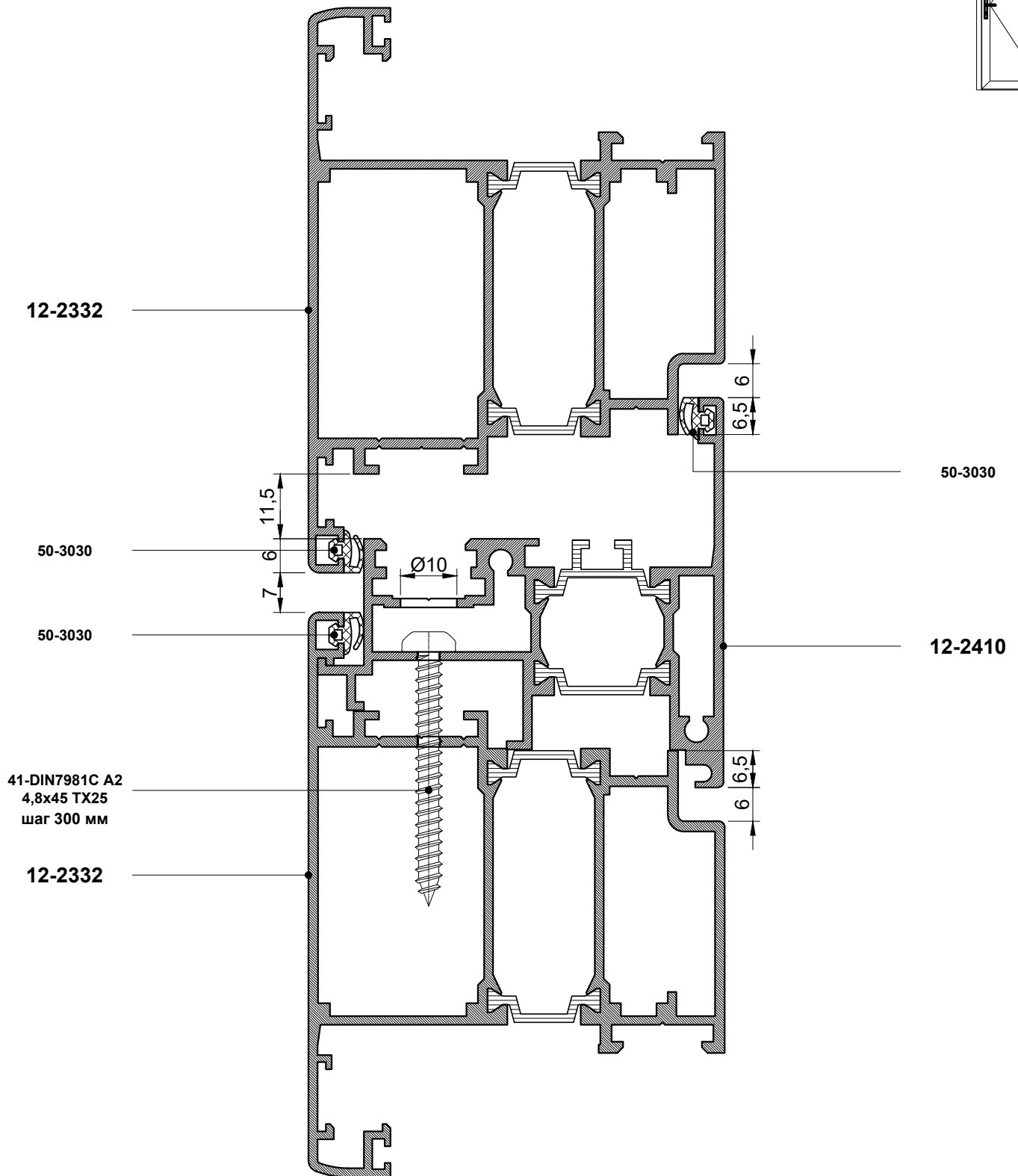
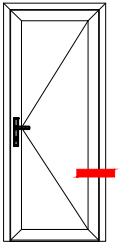

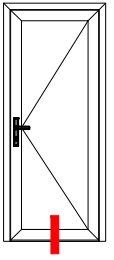

12-2332

50-3030

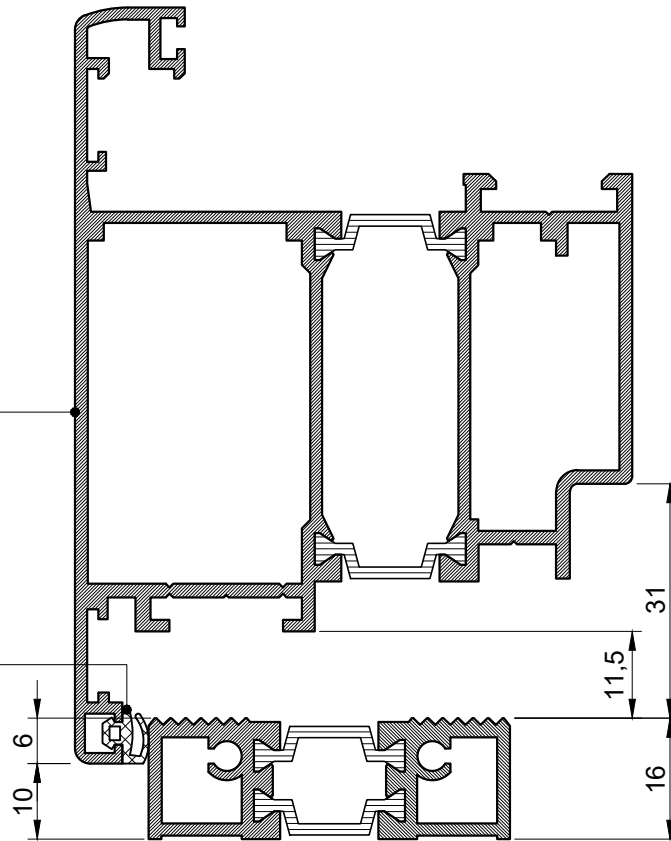

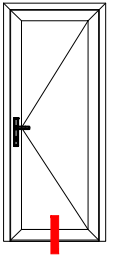

12-2332

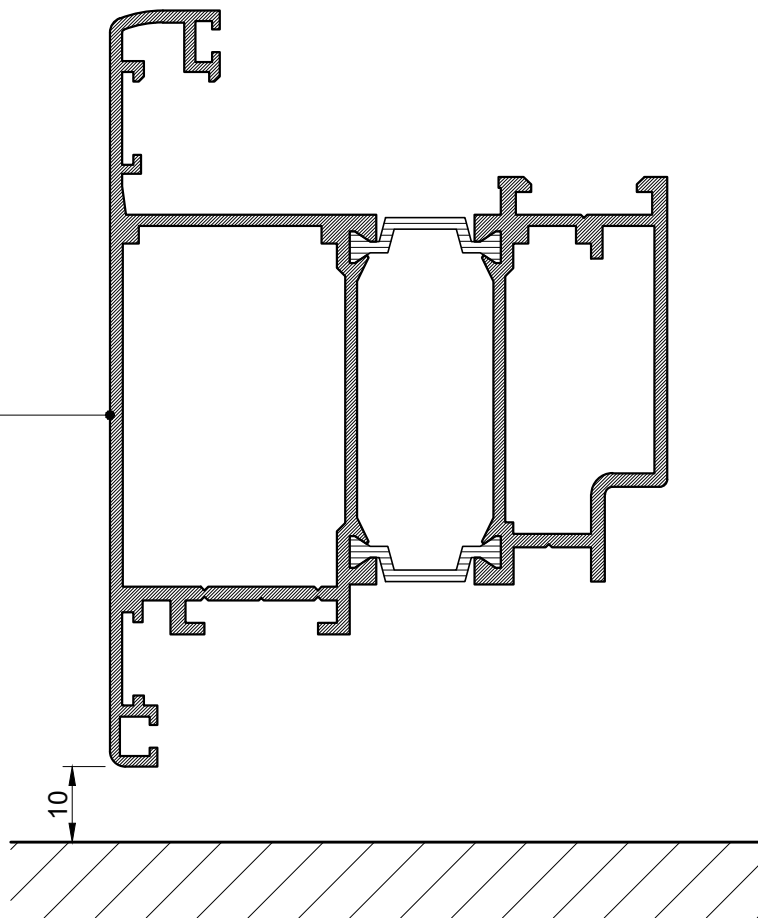



12-2141

12-2152

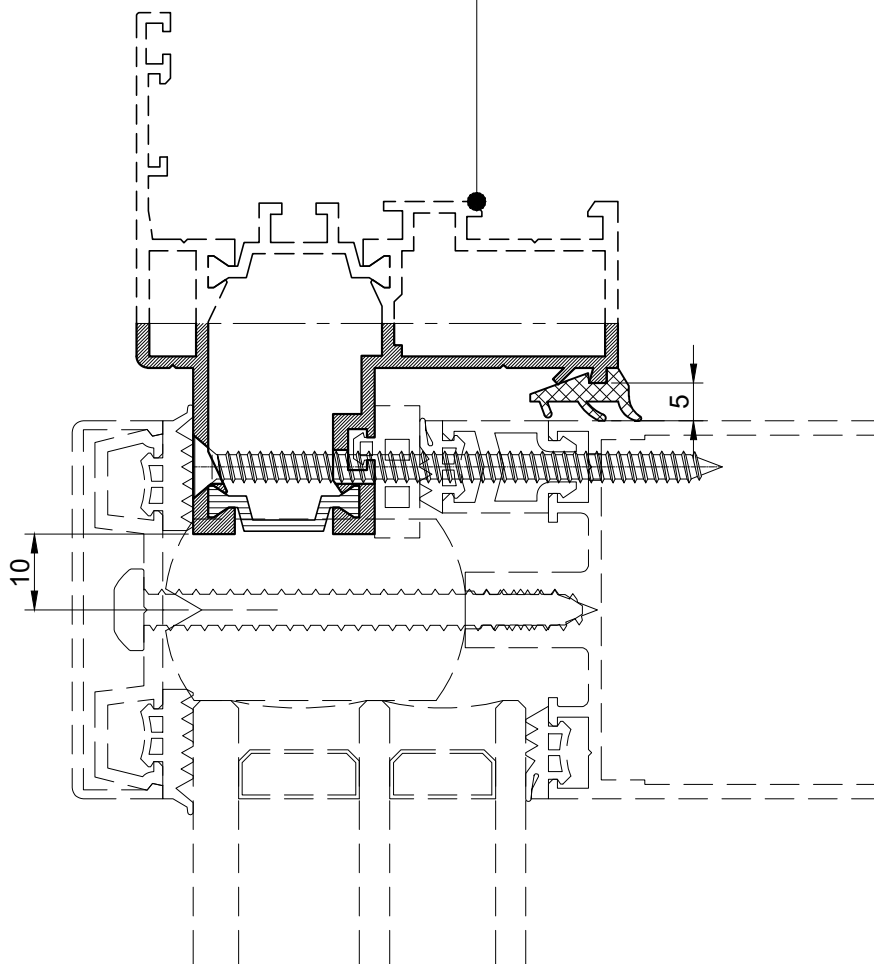
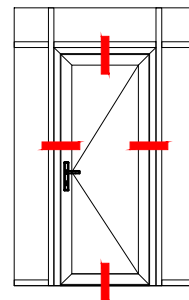
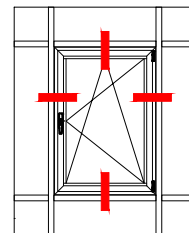
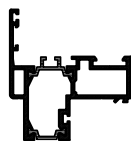
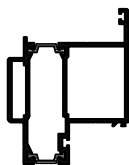

**Смотри каталог F50**



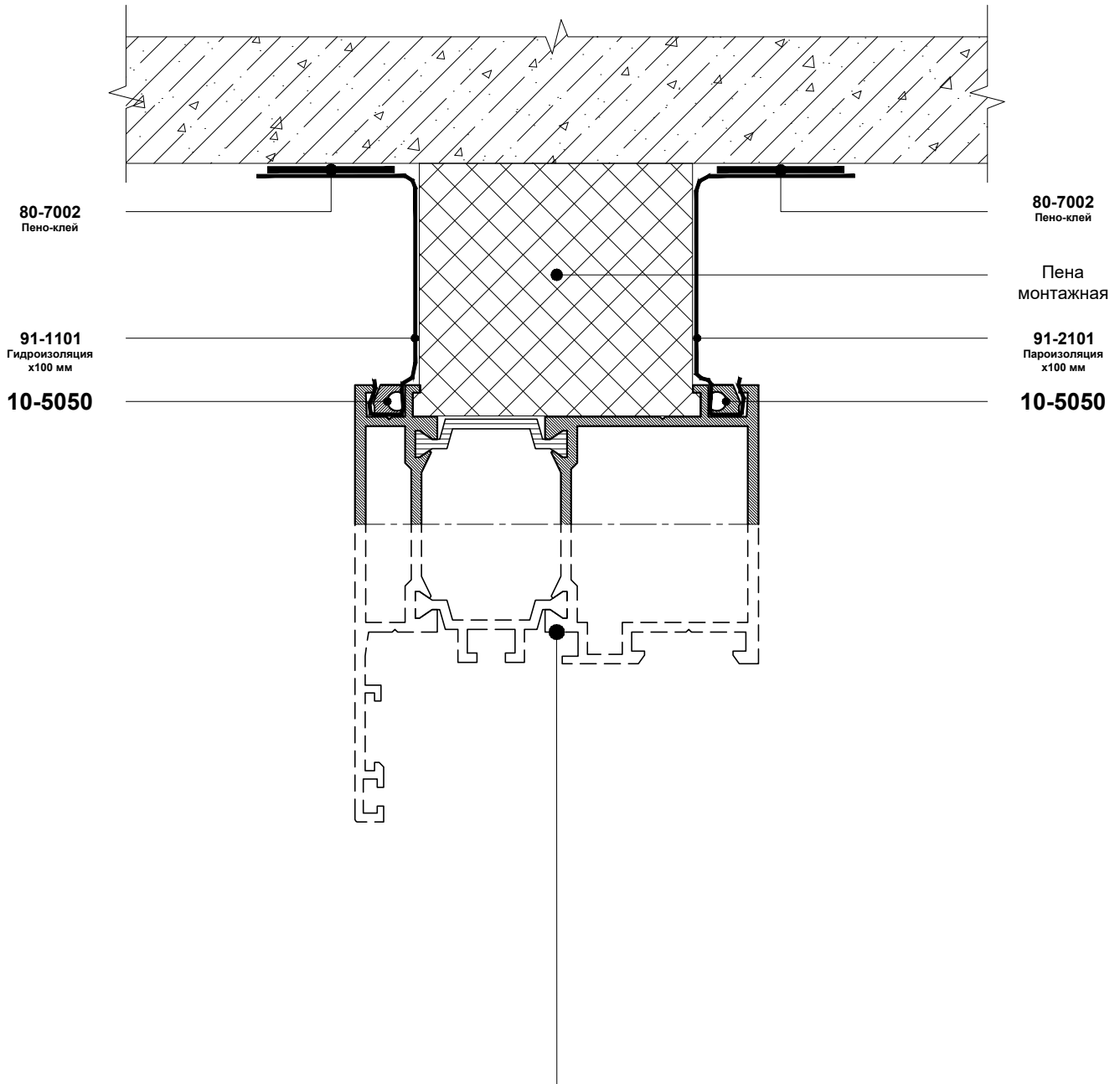
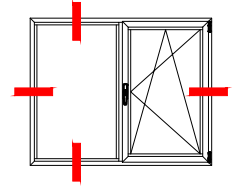

12-2110

12-2111

12-2122

12-2130

12-2131

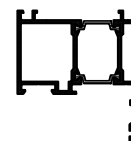
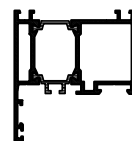
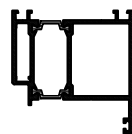
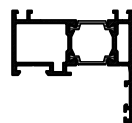
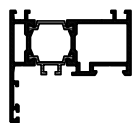

12-2110

12-2111

12-2122

12-2130

12-2131

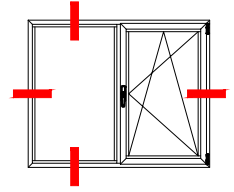
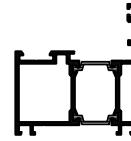
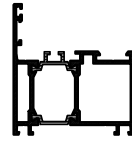
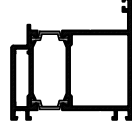
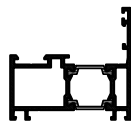
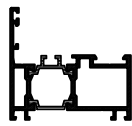

**80-6002**  
Клей гибридный полимерный  
blaugelb Power Fix

**10-5050**

**91-1101**  
Гидроизоляция  
x100 мм

**65-1004**  
Trioterm  
35x42 мм

**80-7002**  
Пено-клей

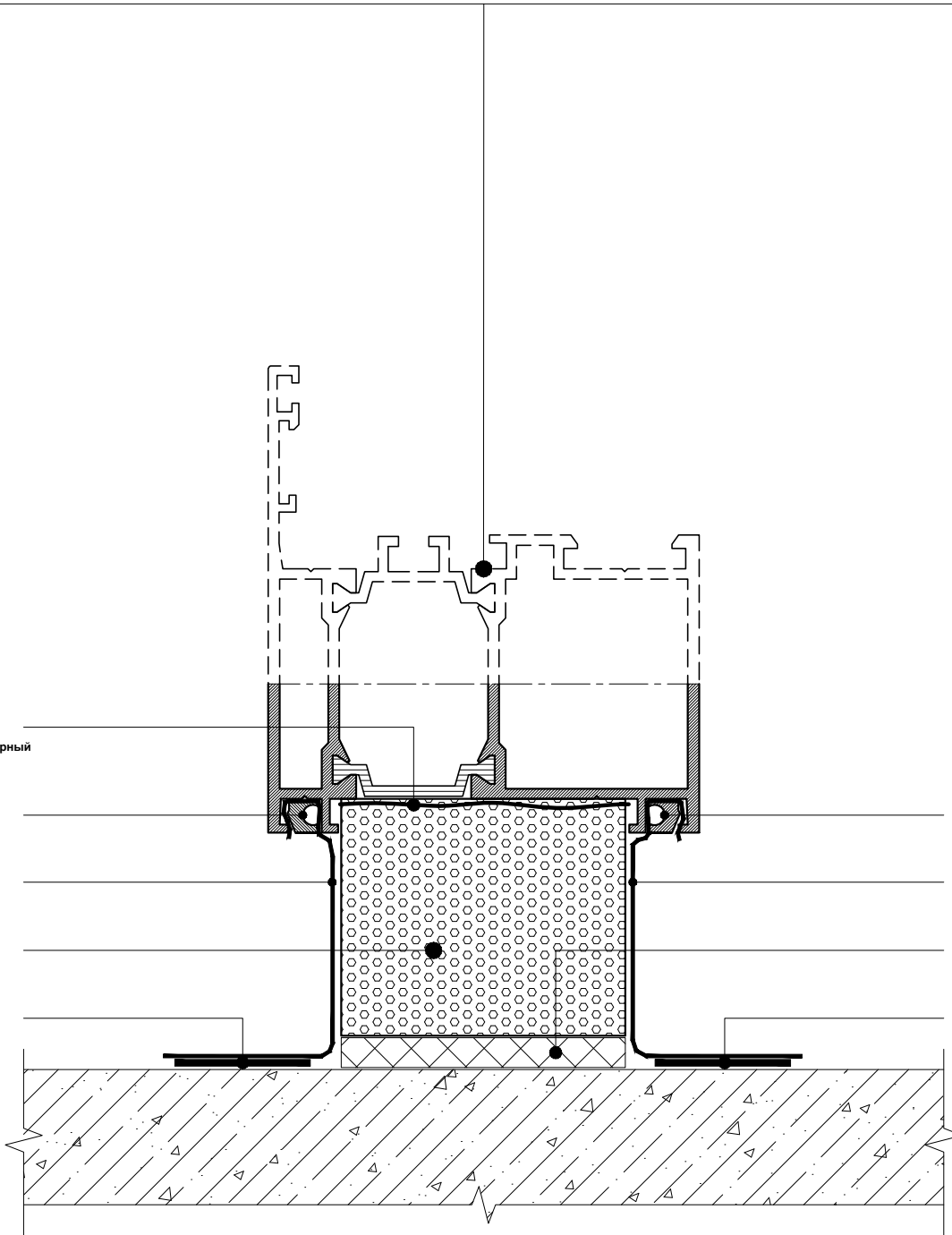

**10-5050**

**91-2101**  
Пароизоляция  
x100 мм

Пена  
МОНТАЖНАЯ

**80-7002**  
Пено-клей



12-2110

12-2111

12-2122

12-2130

12-2131

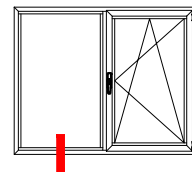
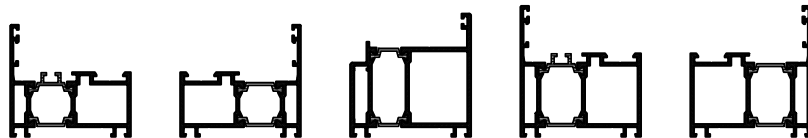

10-5050

91-1101  
Гидроизоляция  
x100 мм

80-7002  
Пено-клей

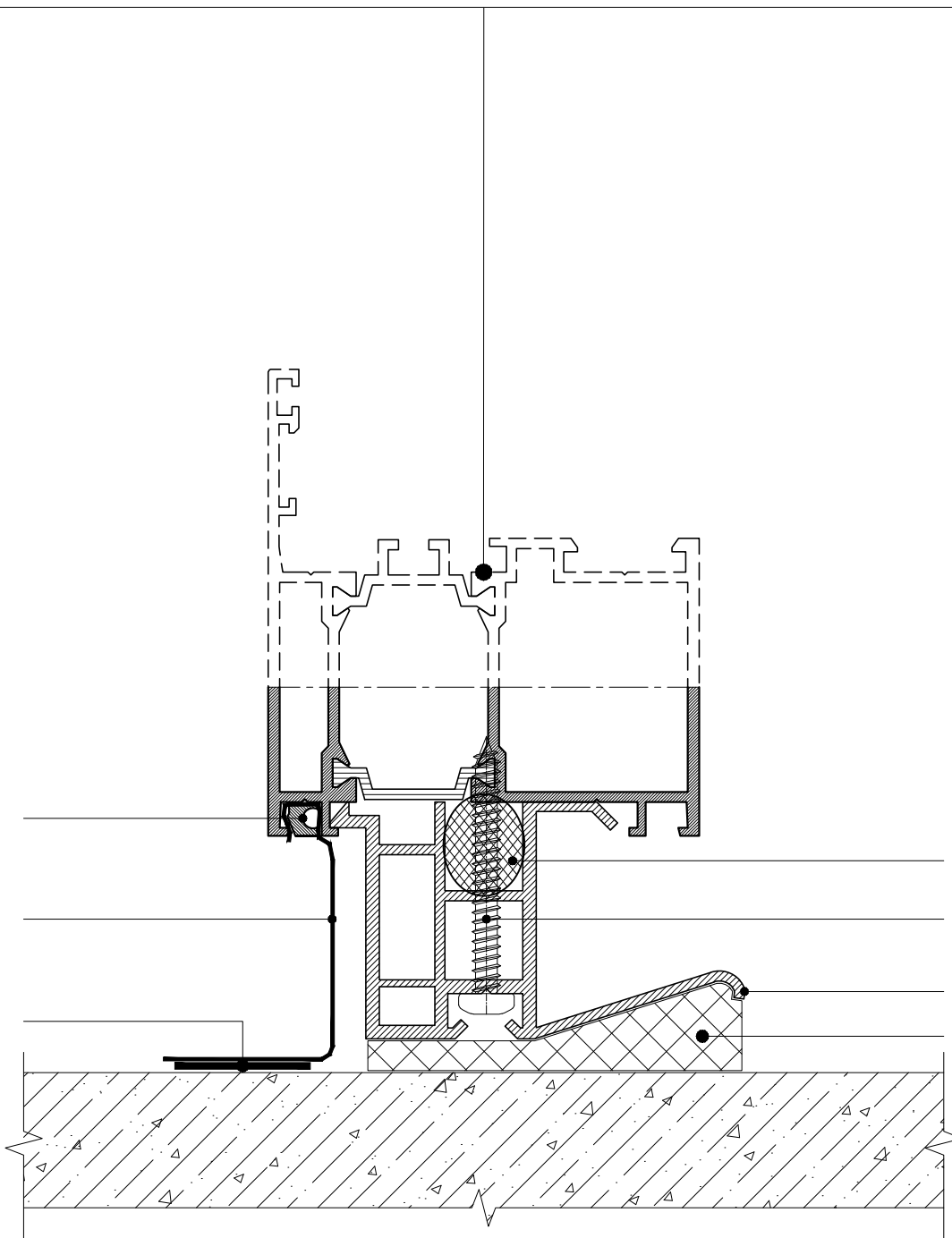

52-0150

41-DIN7981C A2  
4,2x38 TX20  
шаг 300 мм

65-1001

Пена  
монтажная



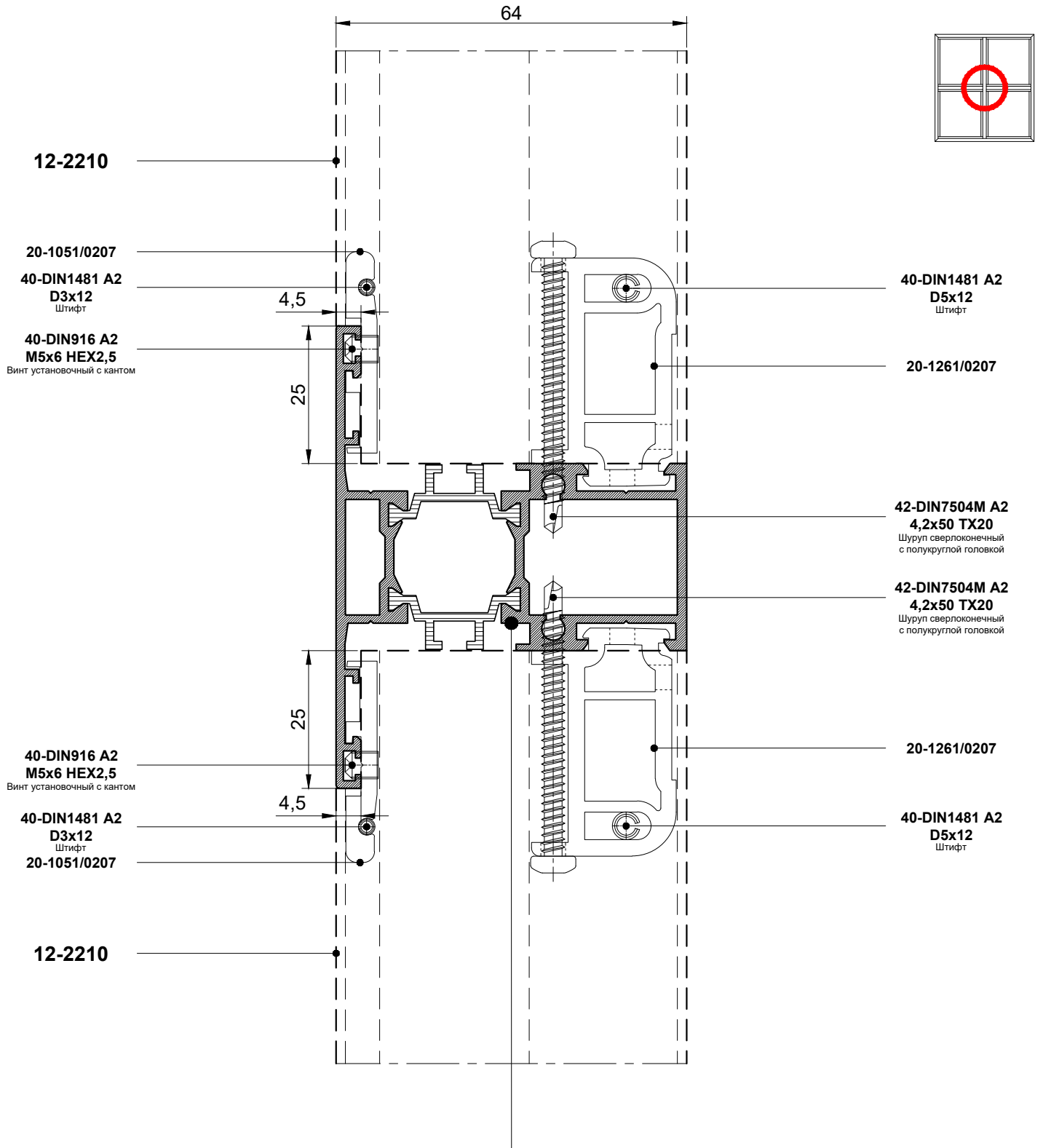

12-2210

12-2220

12-2221

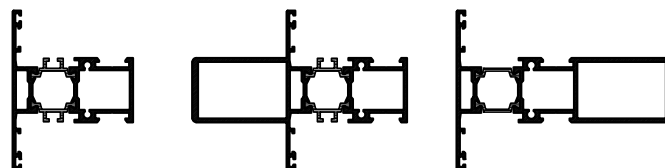

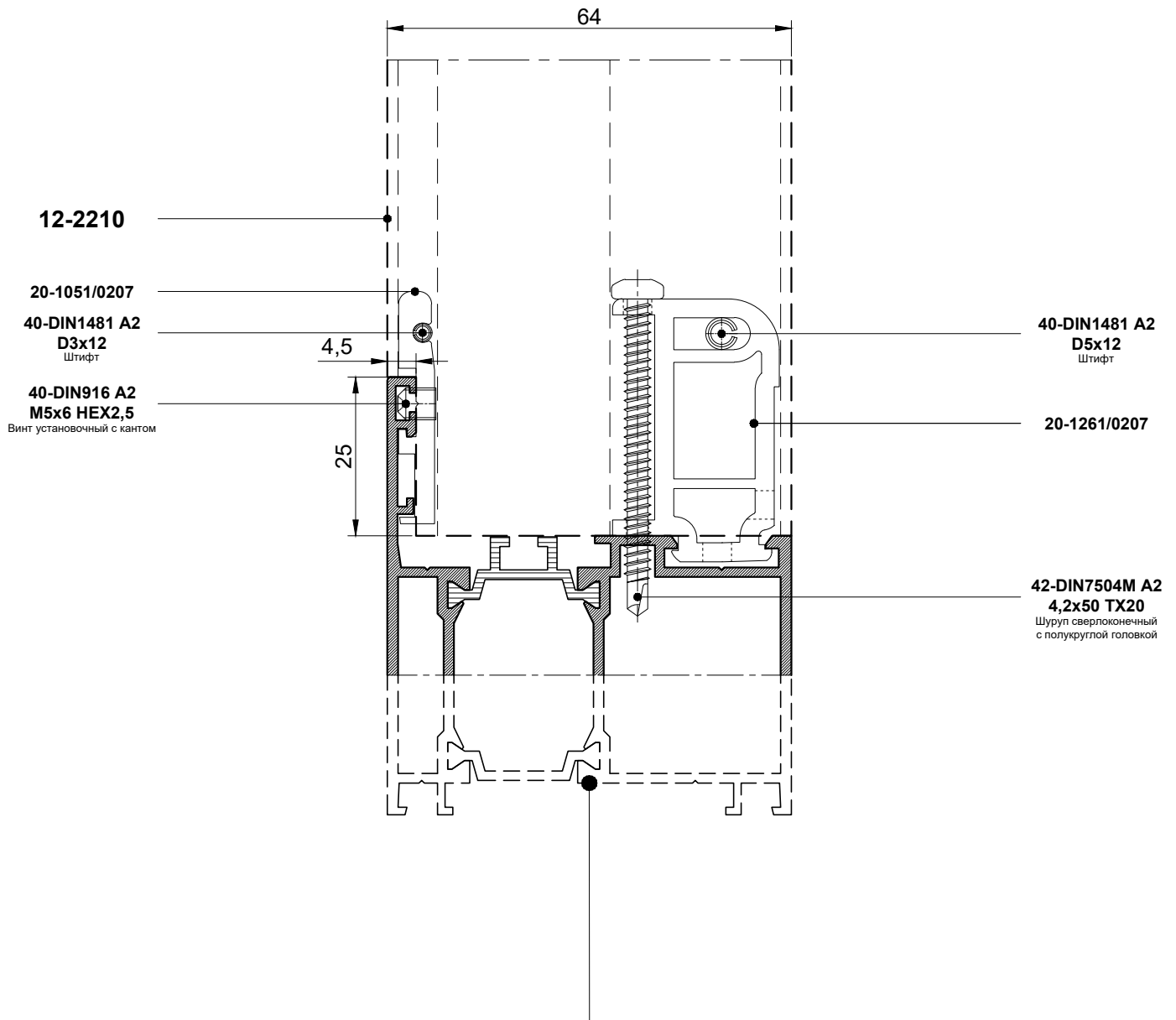
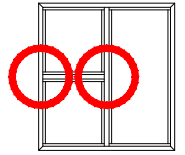

12-2110

12-2130

12-2152

12-2210

12-2220

12-2221

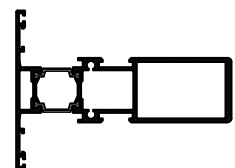
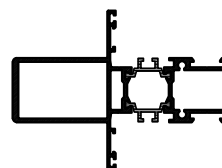
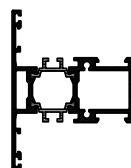
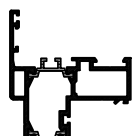
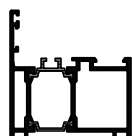
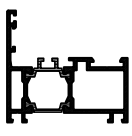

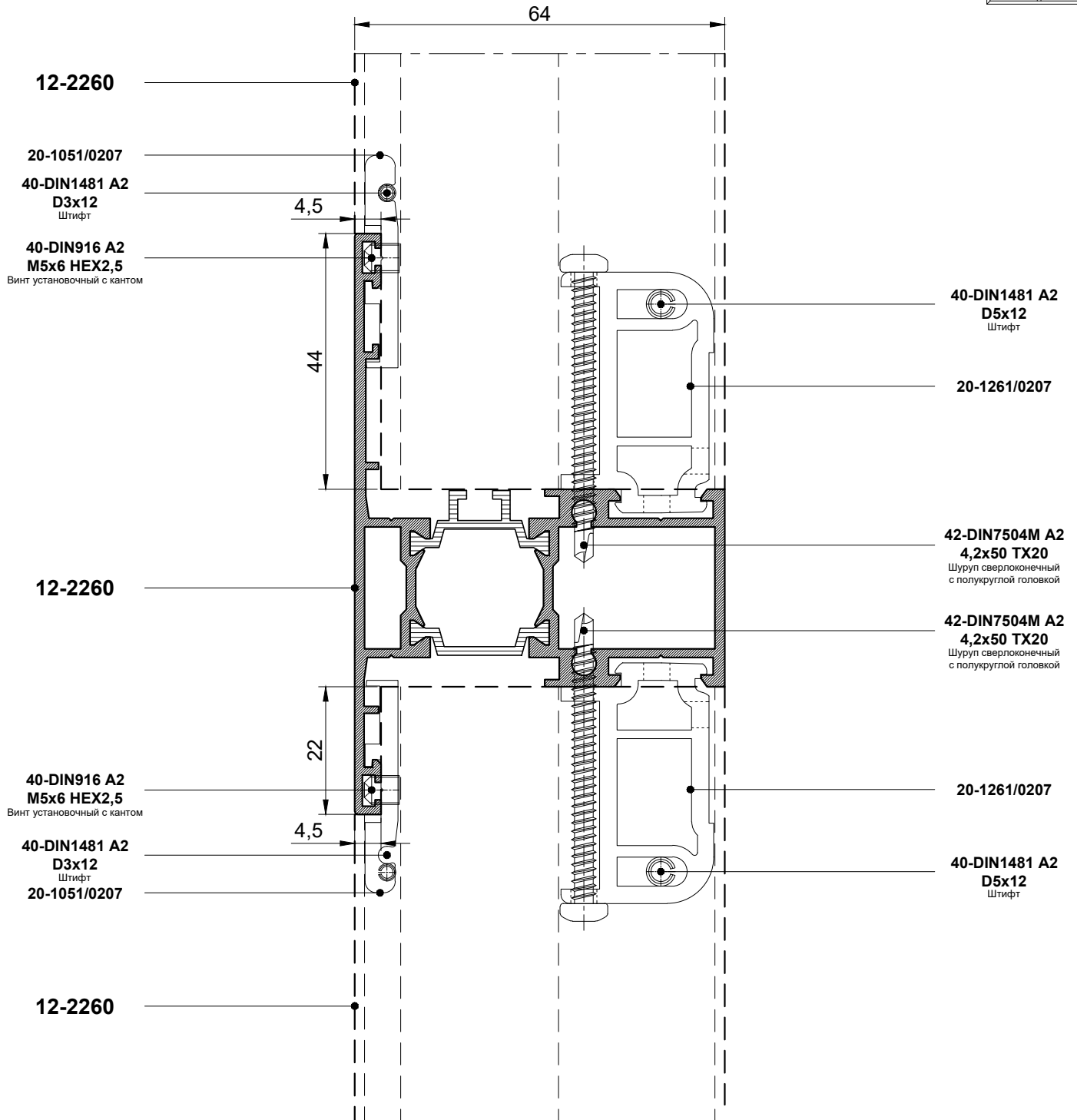
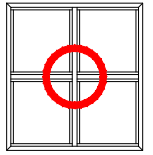

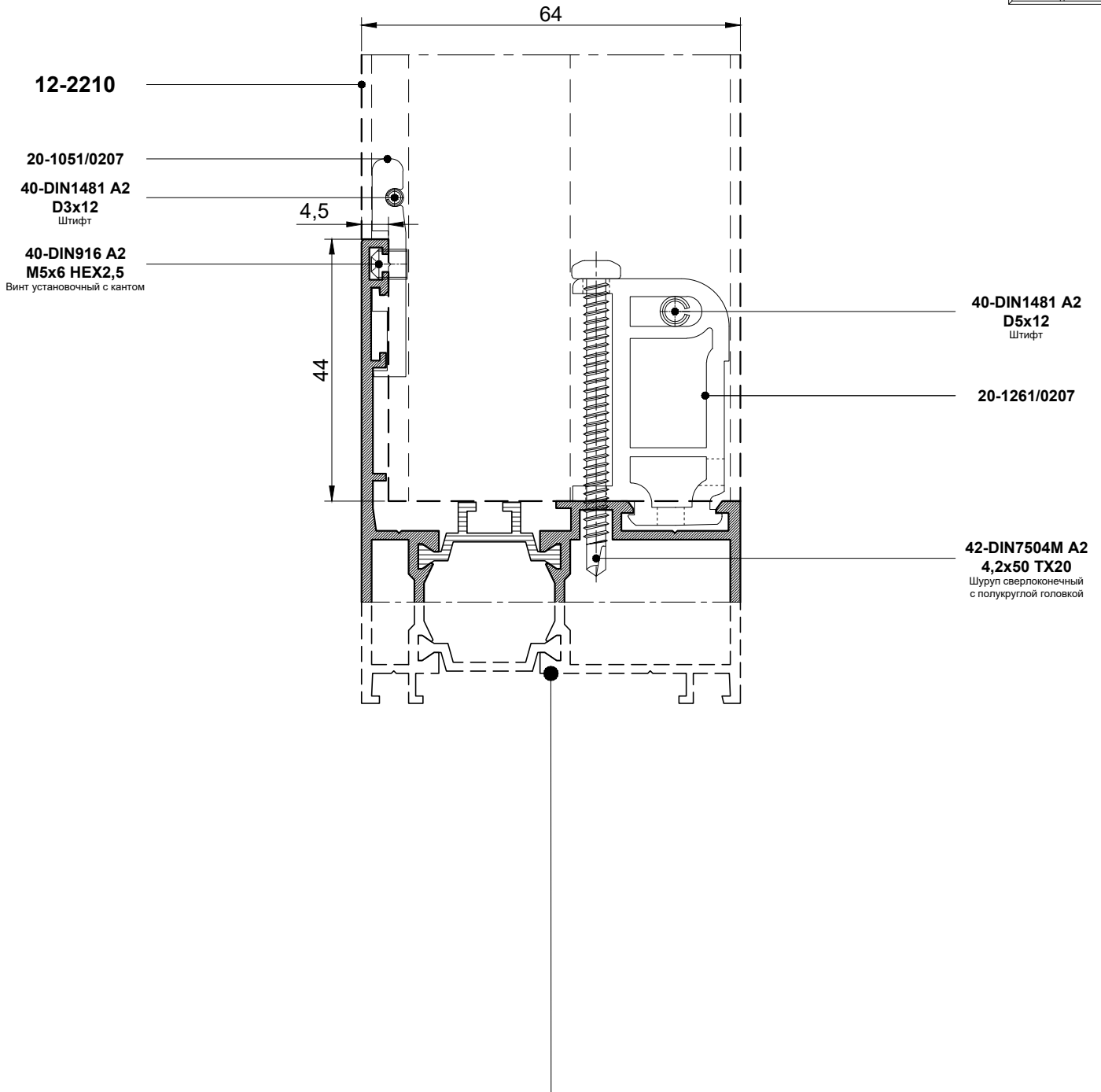
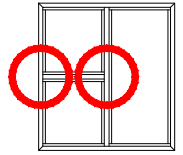

12-2160

12-2260

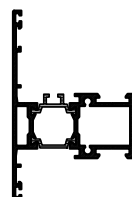
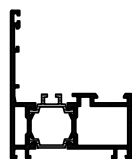



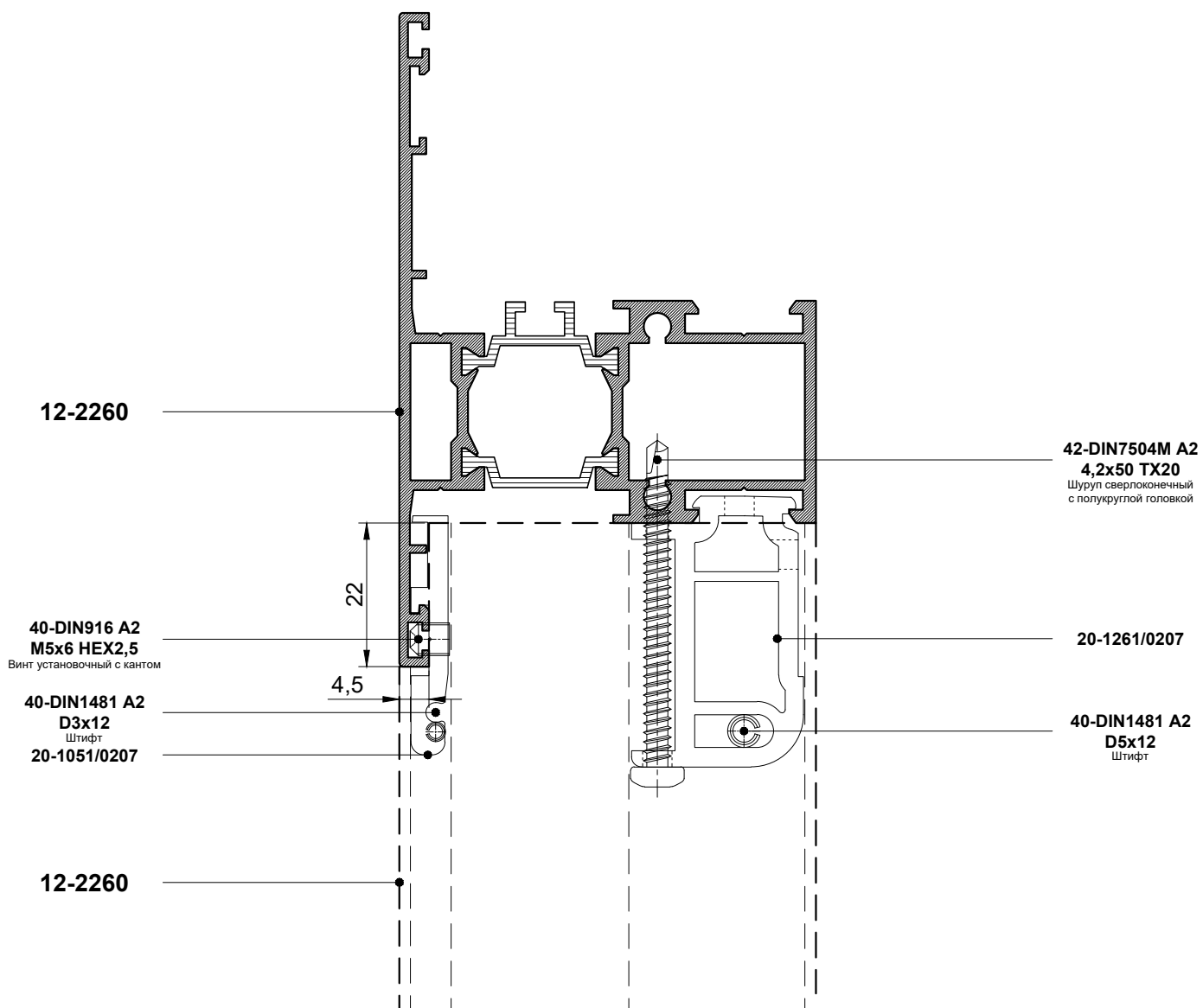
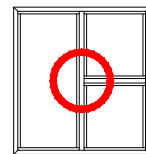

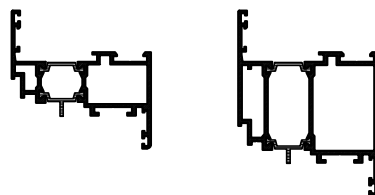
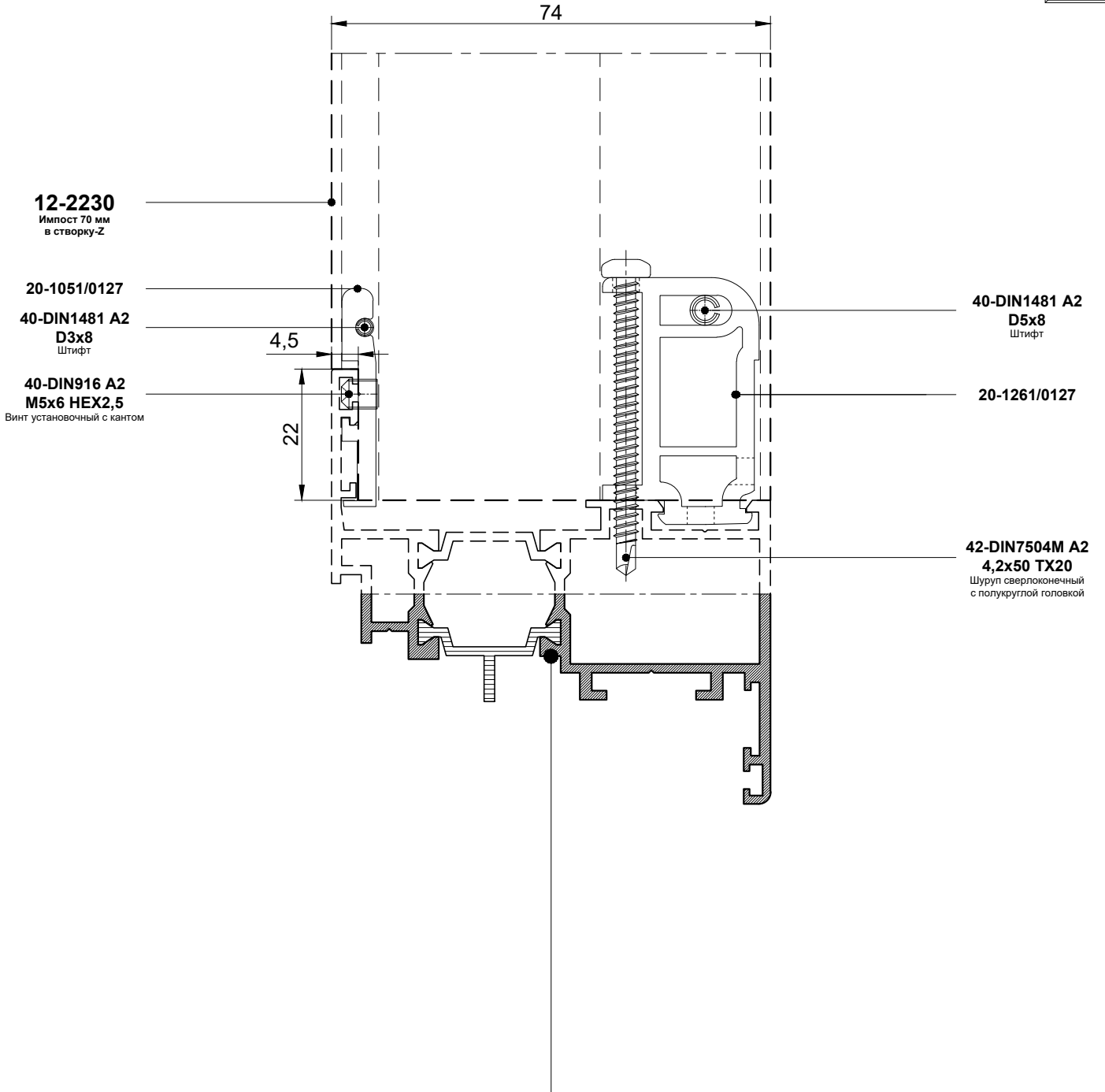
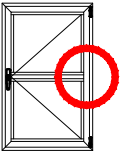

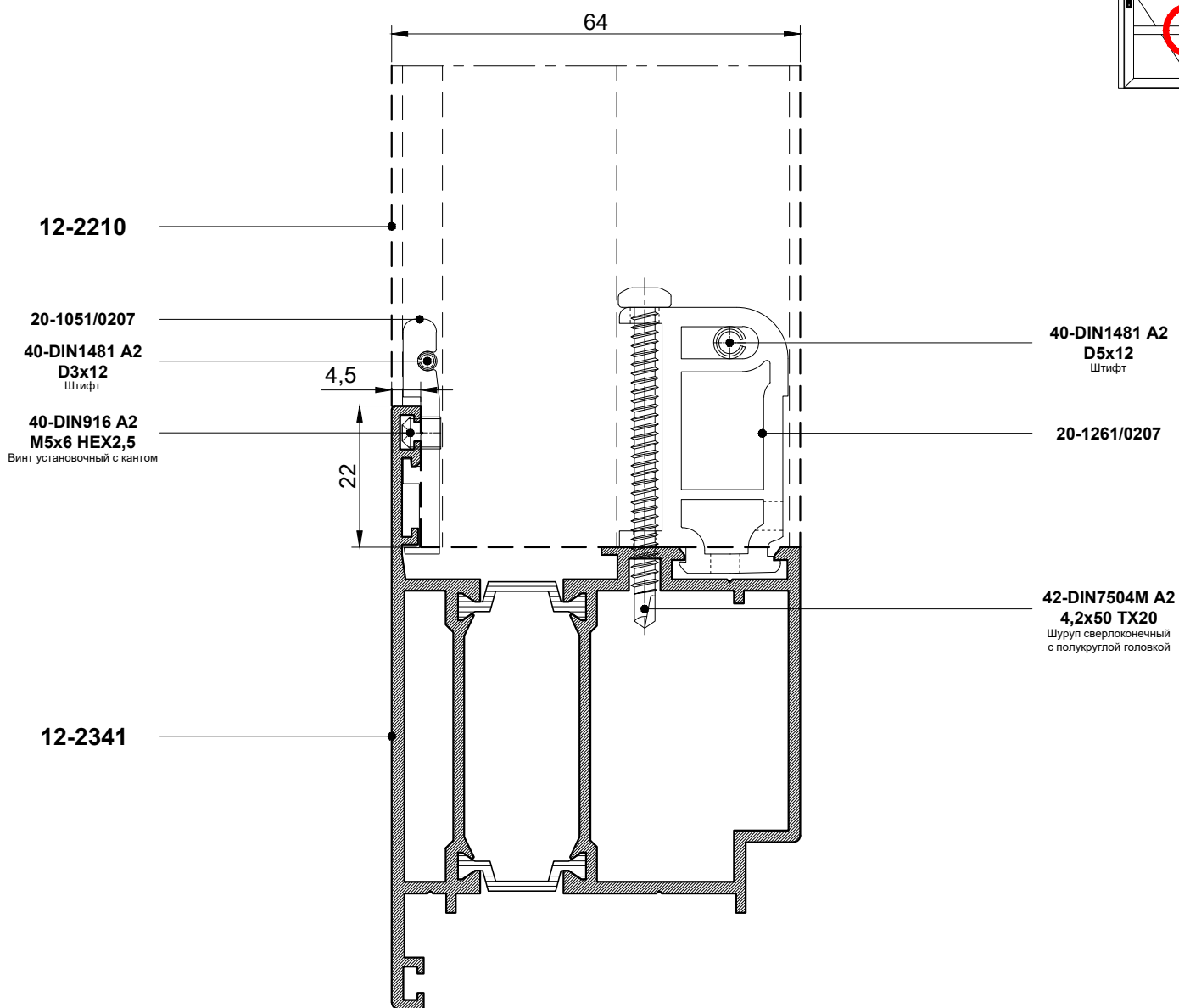
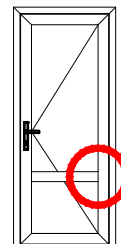

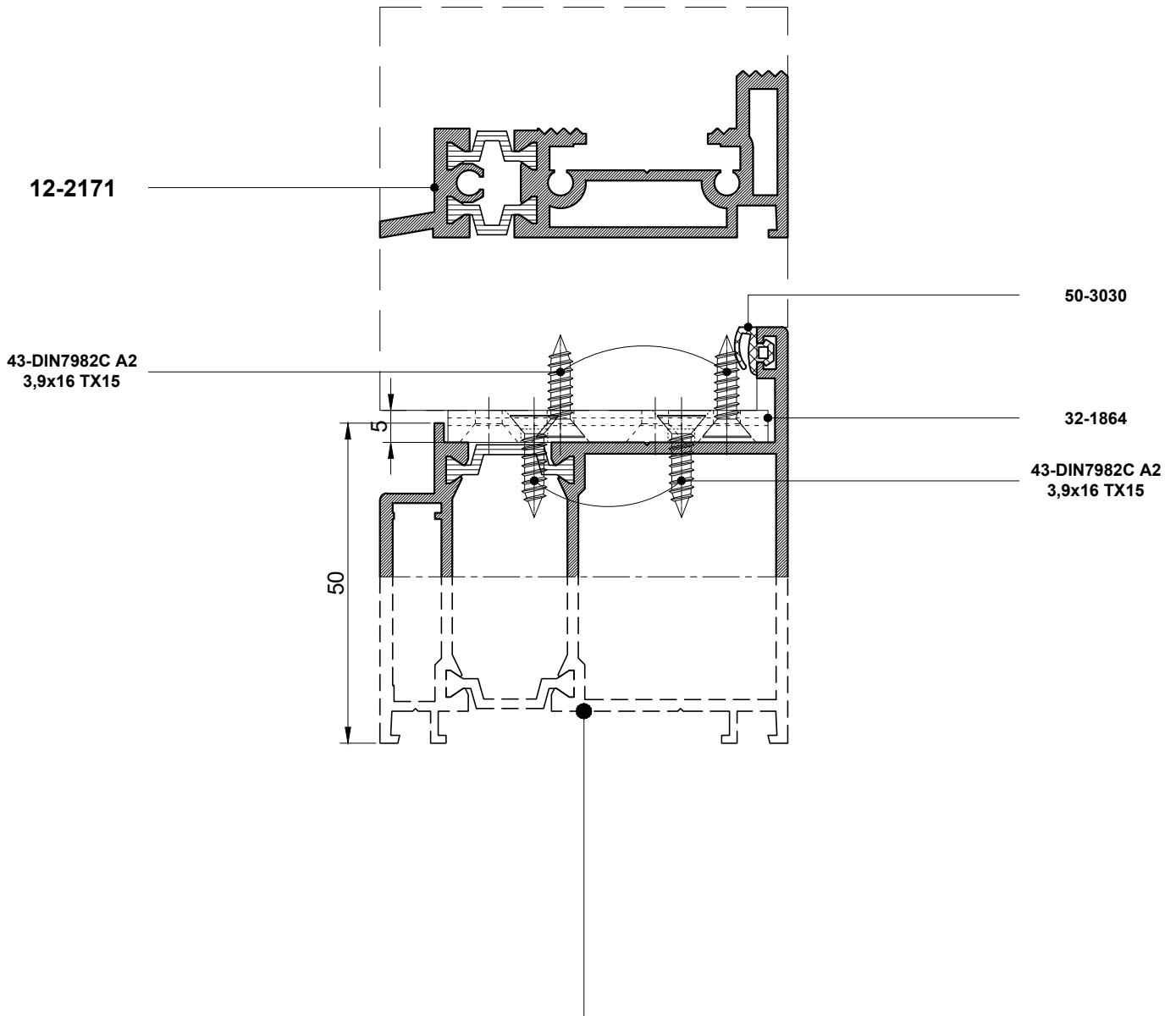
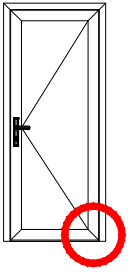

12-2122

12-2141

12-2431

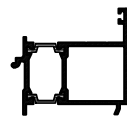
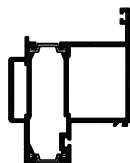
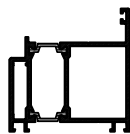

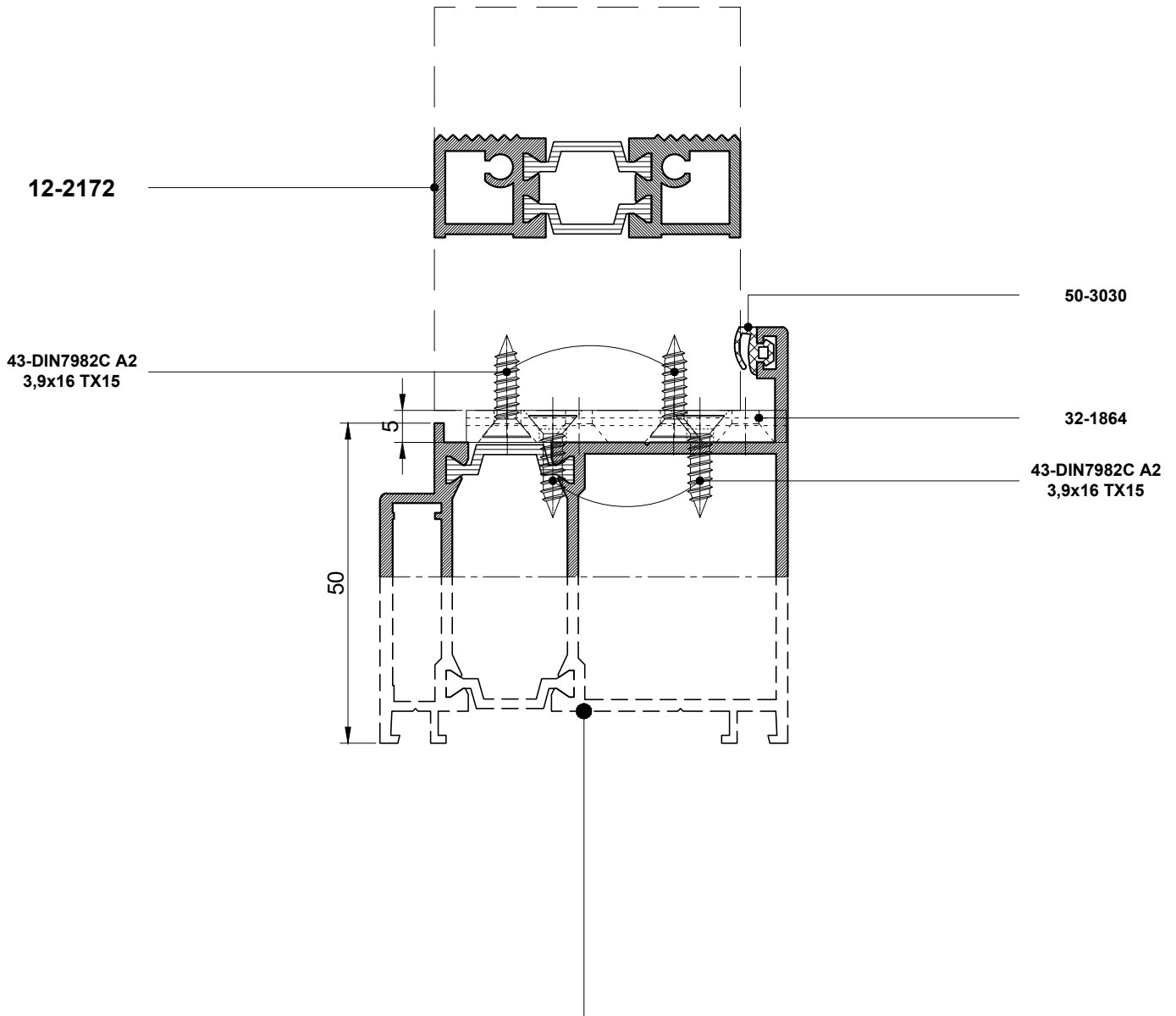
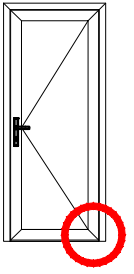

12-2122

12-2141

12-2431

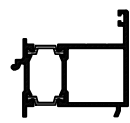
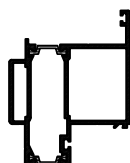
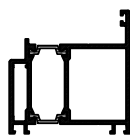

12-2110

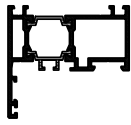

12-2130

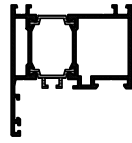

12-2152

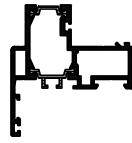

12-2210

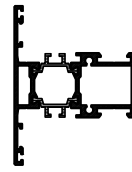

12-2220

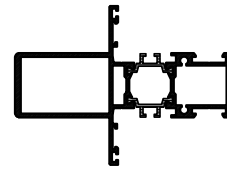

33-2064  
Комплект заглушек  
штульповых оконных WD64

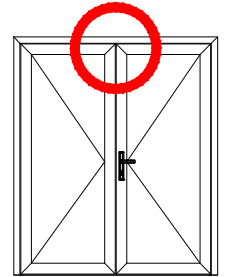
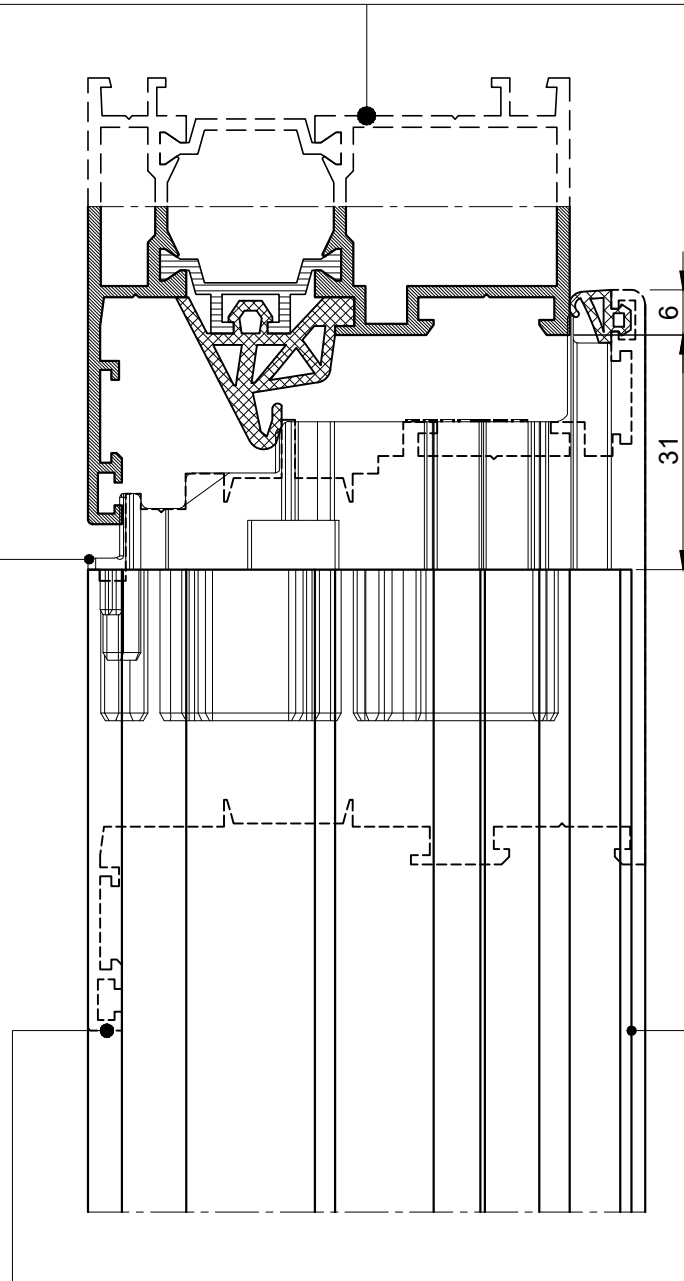

12-2410

12-2320

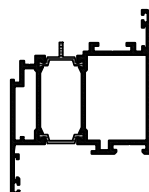

12-2122

12-2141

12-2431

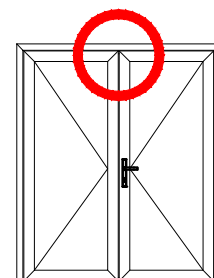
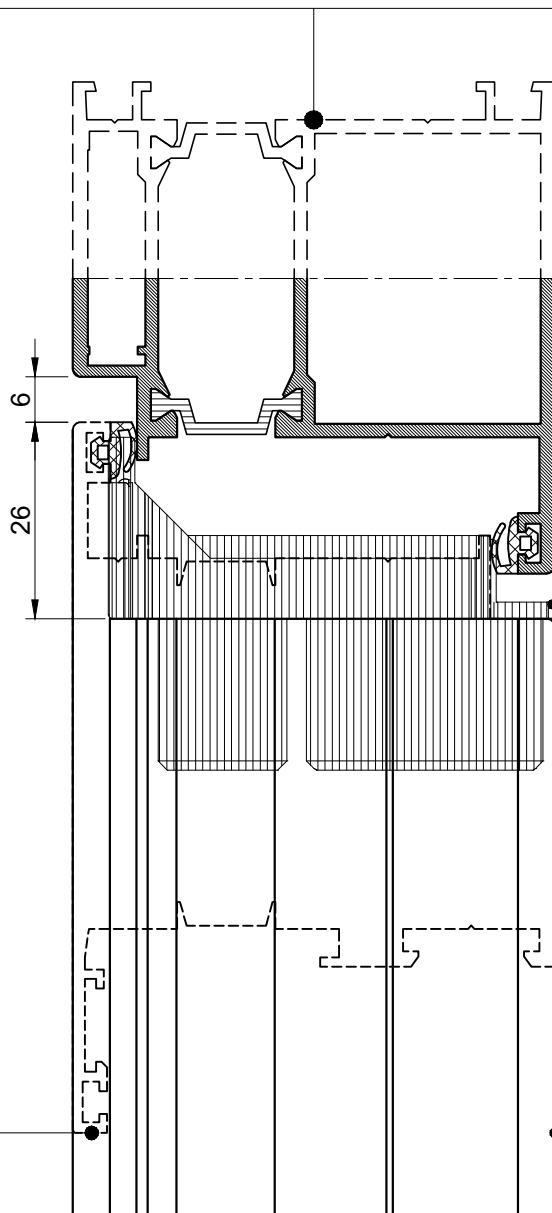
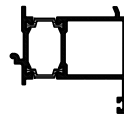
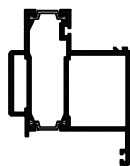
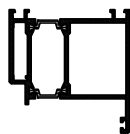

**33-1964**  
Комплект заглушек  
штульповых дверных WD64

12-2421

12-2341

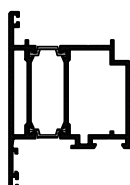

12-2341

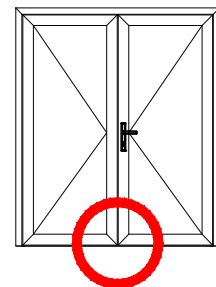
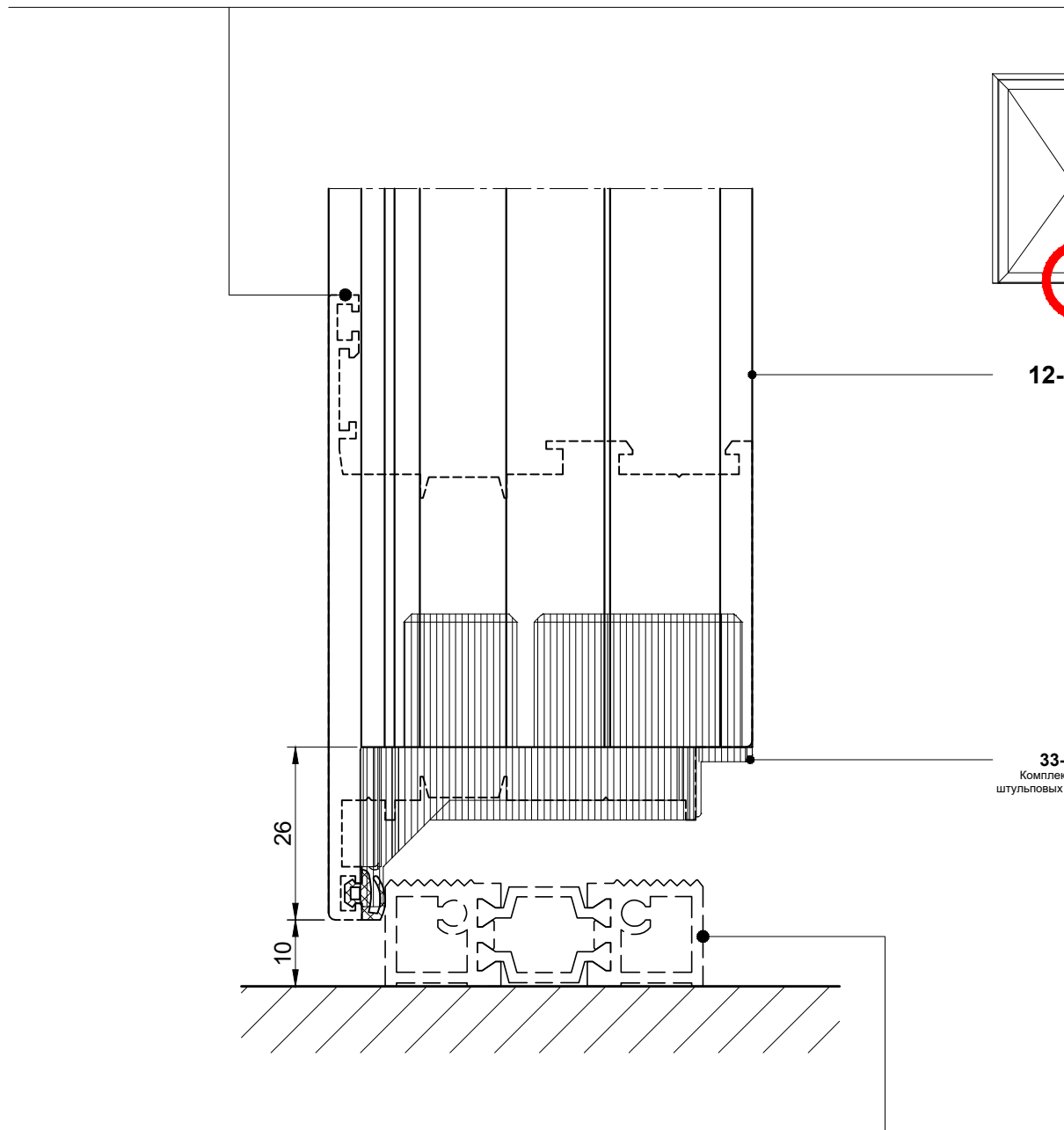
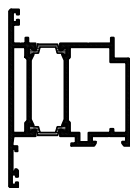

12-2421

33-1964  
Комплект заглушек  
штульповых дверных WD64

12-2172  
(опция)





12-2341

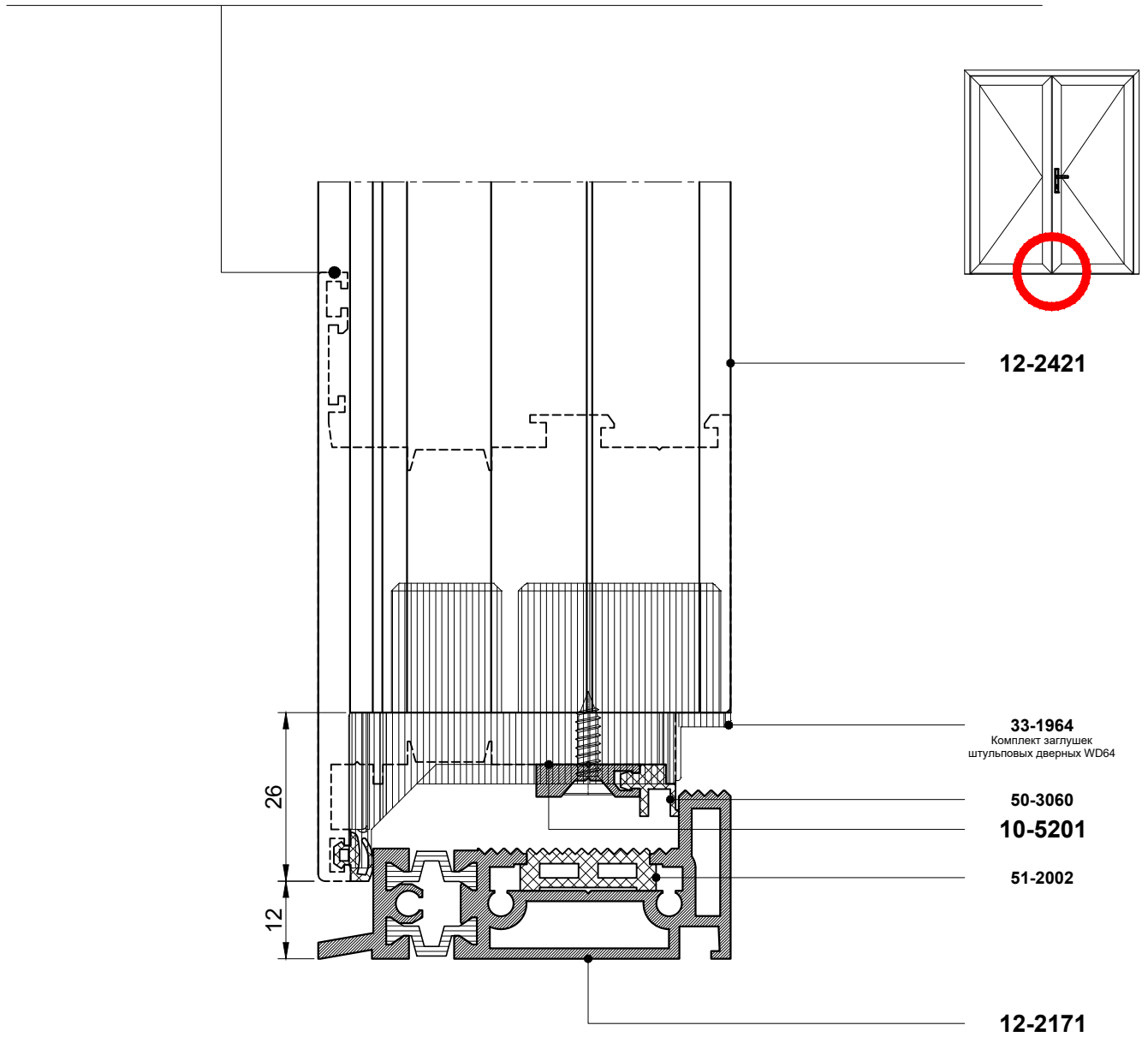
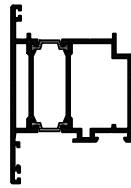

12-2111

12-2131

12-2440

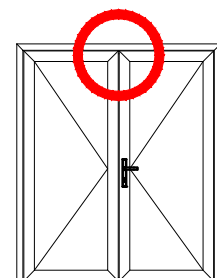
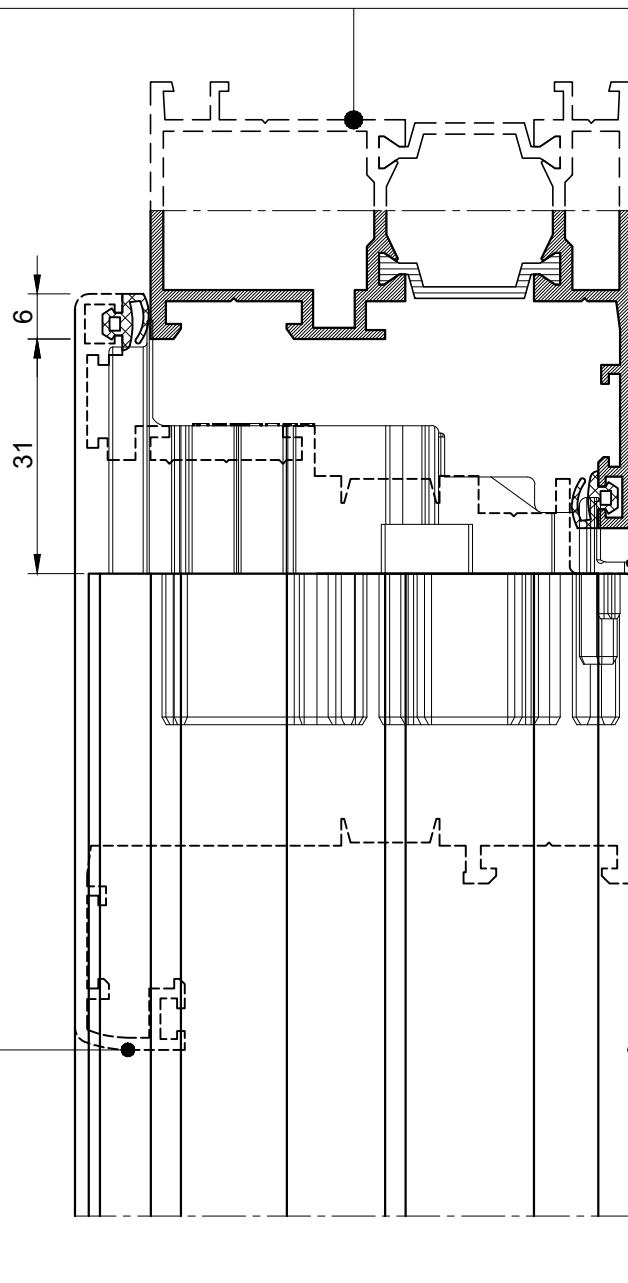
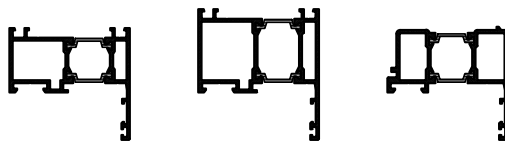

**33-2064**  
Комплект заглушек  
штульповых оконных WD64

12-2410

12-2332

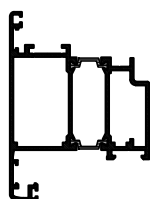

12-2332

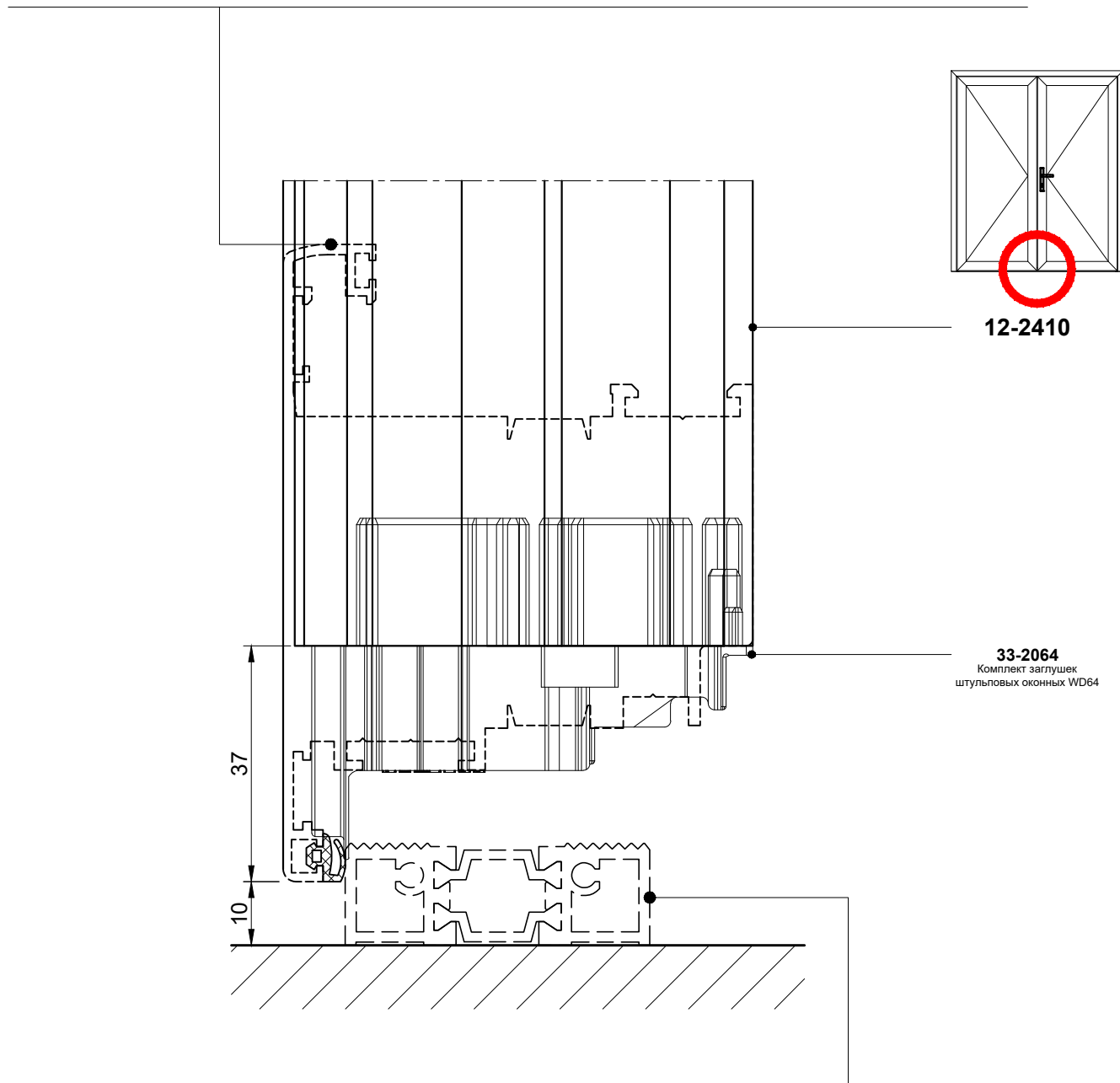
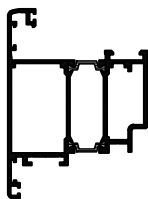

12-2172  
(опция)



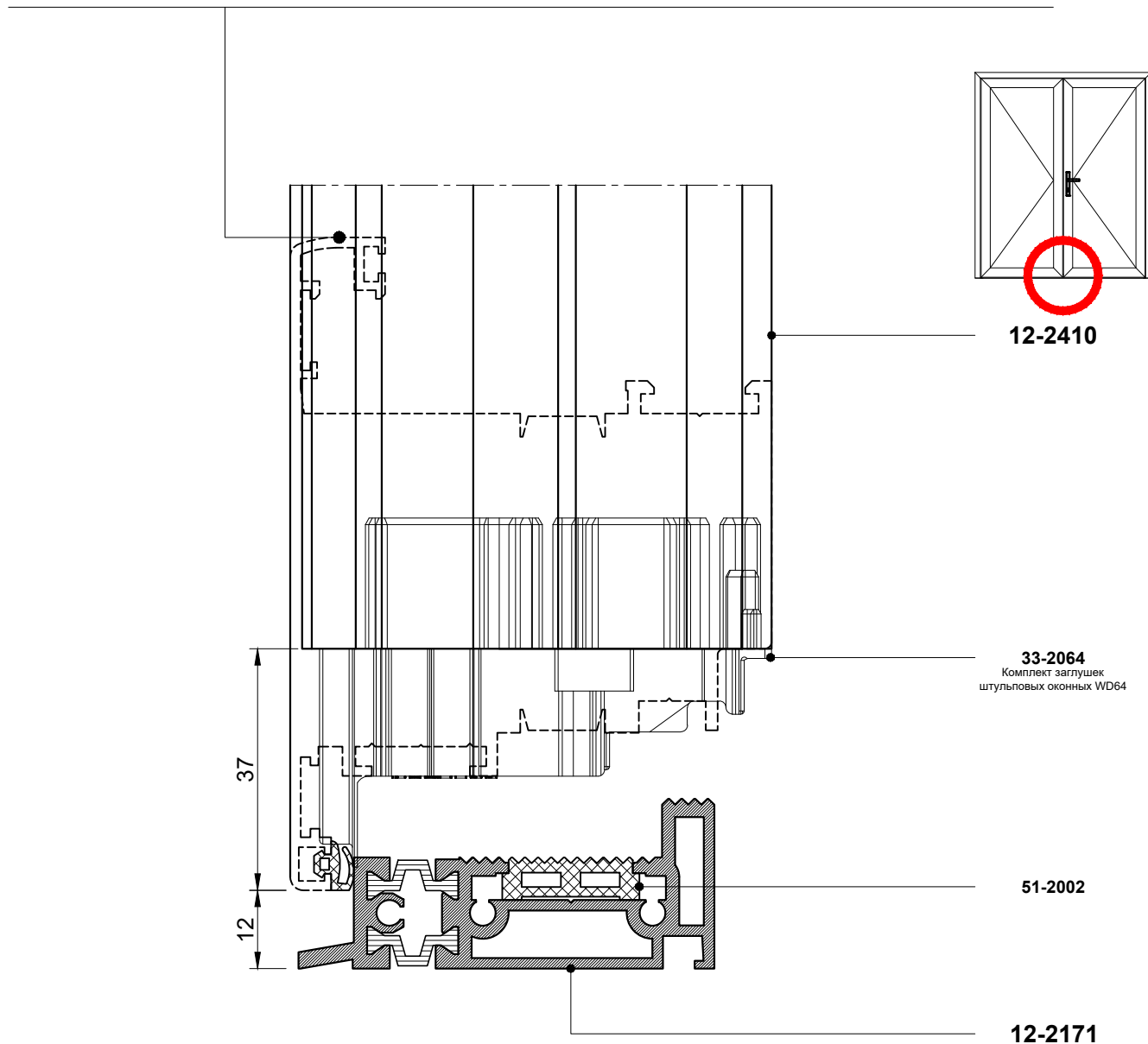
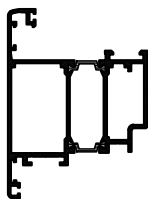

12-2332

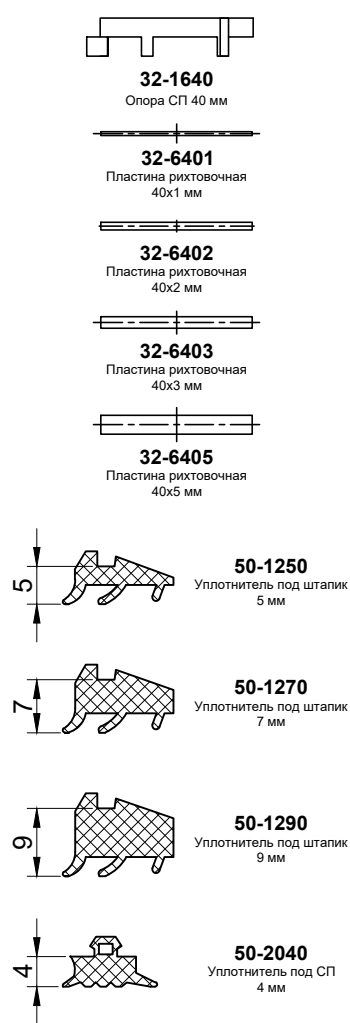
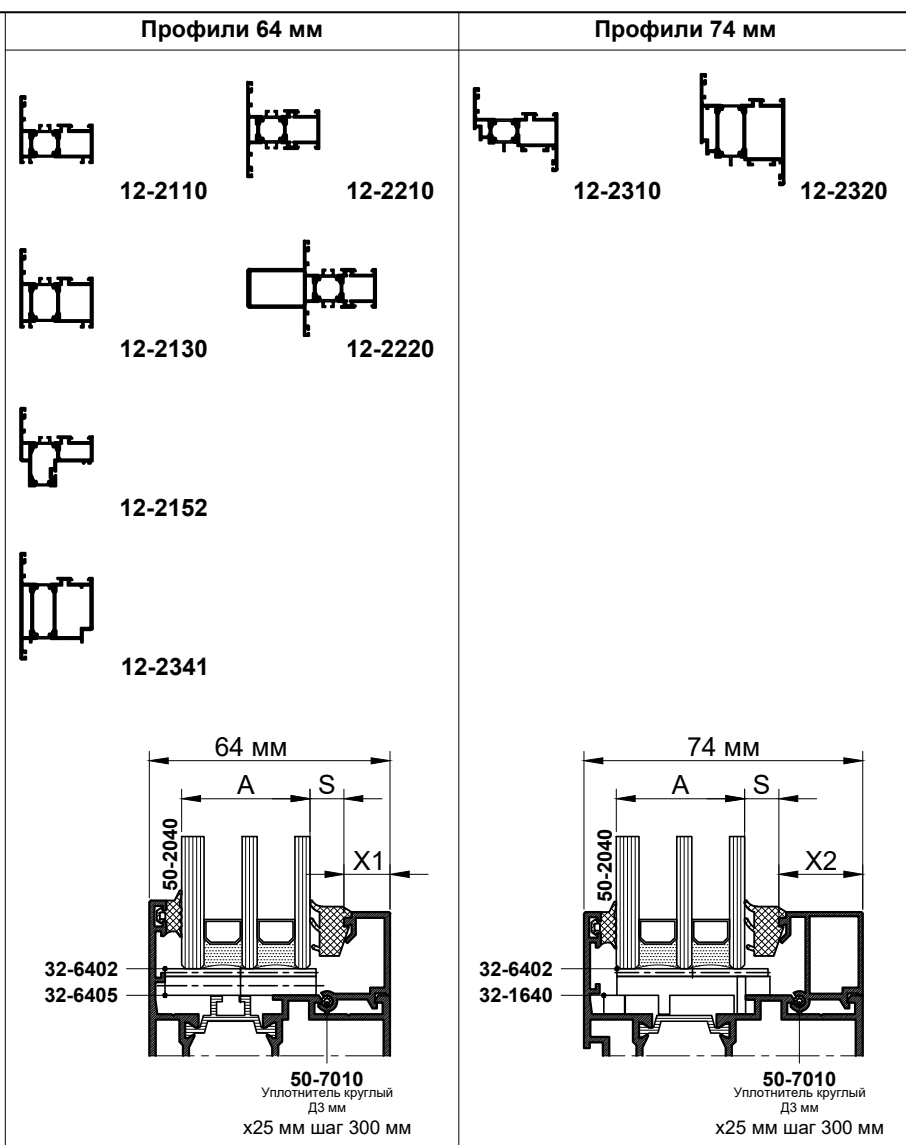

Толщина заполнения, А мм	Профили 64 мм		Профили 74 мм		Уплотнитель	
	Артикул	X1, мм	Артикул	X2, мм	Артикул	S, мм
	6					50-1270
8					50-1250	5
10					50-1290	9
12	10-3360	36,5	10-3460	46,5	50-1270	7
14					50-1250	5
16	10-3320	32,5	10-3420	42,5	50-1270	7
18					50-1250	5
20					50-1290	9
22	10-3260	26,5	10-3360	36,5	50-1270	7
24					50-1250	5
26	10-3220	22,5	10-3320	32,5	50-1270	7
28					50-1250	5
30					50-1290	9
32	10-3160	16,5	10-3260	26,5	50-1270	7
34					50-1250	5
36	10-3120	12,5	10-3220	22,5	50-1270	7
38					50-1250	5
40						

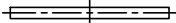
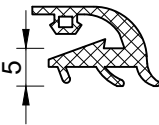
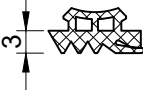
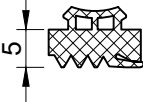

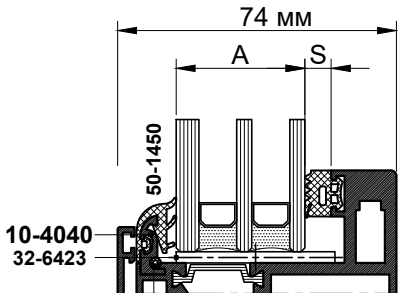
Профили створки скрытой						
 <b>12-2360</b>				 <b>32-6423</b> Пластина рихтовочная 42x3 мм		
 <b>50-1450</b> Уплотнитель под штапик 5 мм створки скрытой				 <b>50-5030</b> Уплотнитель внутренний 3 мм		
 <b>50-5050</b> Уплотнитель внутренний 5 мм				 <b>50-5070</b> Уплотнитель внутренний 7 мм		
 <b>10-4040</b> <b>32-6423</b> <b>50-1450</b> <b>50-7010</b> Уплотнитель круглый Д3 мм На всю длину						
Толщина заполнения, А мм	Штапик				Уплотнитель	
	Артикул				Артикул	S, мм
34	<b>10-4040</b>				<b>50-5070</b>	7
36					<b>50-5050</b>	5
38					<b>50-5030</b>	3



Толщина заполнения, А мм	Профили 64 мм, крыло 44 мм		Профили 64 мм, крыло 22 мм		Уплотнитель	
	Артикул	X1, мм	Артикул	X1, мм	Артикул	S, мм
	34	10-3121	12,5	10-3120	12,5	50-1290
36	50-1270					7
38	50-1250					5

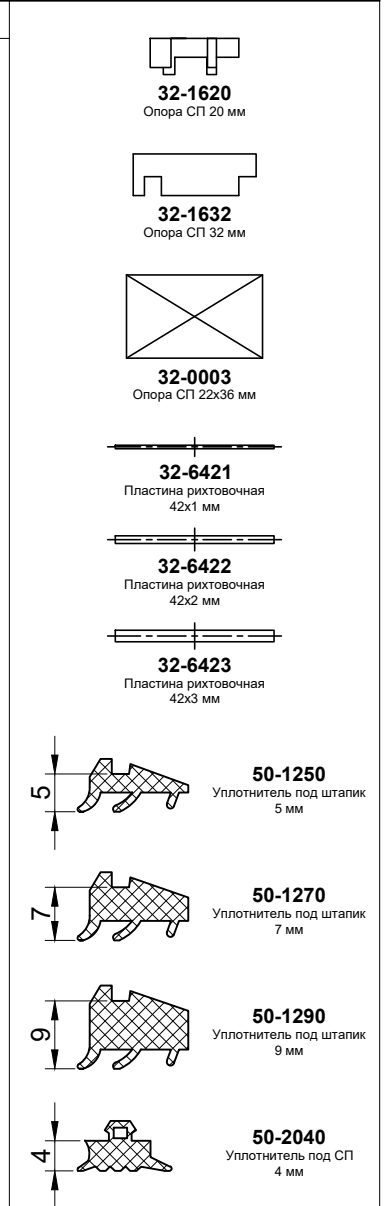
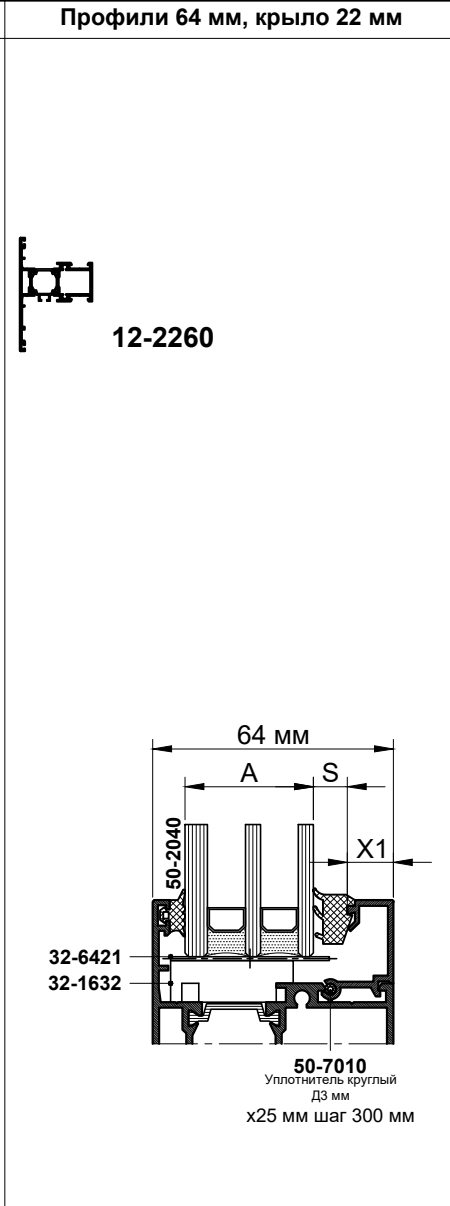
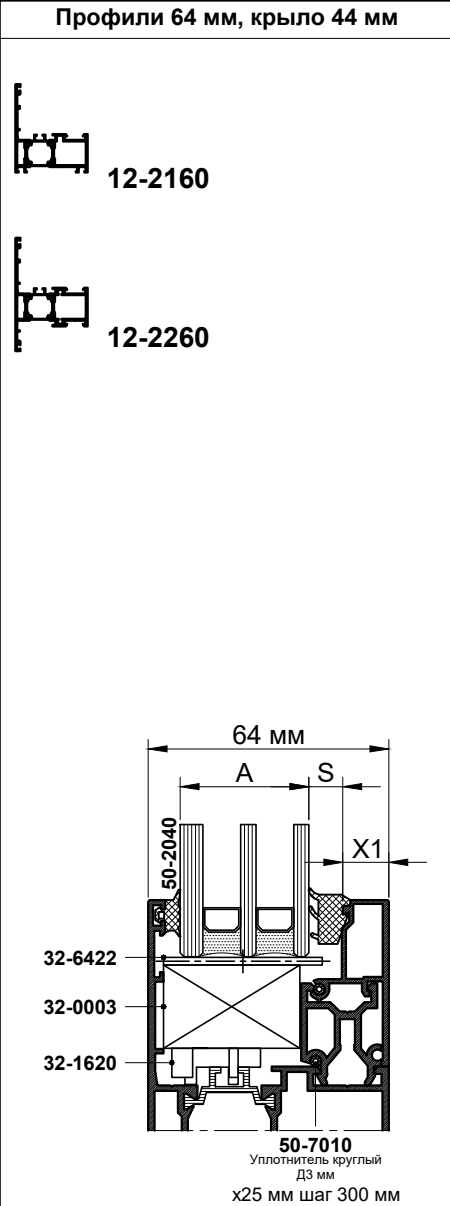

№ Комплекта	Схема изделия	Артикул	№ Комплекта	Схема изделия	Артикул
1		12-2110 12-2130 12-2210 12-2220 12-2221	2		12-2310 12-2320
3		12-2310 12-2320 12-2332	4		12-2310 12-2320
5		12-2310 12-2320 12-2332	6		12-2310 12-2320
7		12-2341			

№ Комплекта	Опора стеклопакета	Пластина рихтовочная			
	32-1640 Опора СП 40 мм	32-6401 Пластина рихтовочная 40x1 мм	32-6402 Пластина рихтовочная 40x2 мм	32-6403 Пластина рихтовочная 40x3 мм	32-6405 Пластина рихтовочная 40x5 мм
1		x1	x2		x2
2	x4	x1	x4	x1	
3	x4	x1	x4	x1	
4	x8	x2	x8	x2	
5	x6	x2	x6	x2	
6	x10	x3	x10	x2	
7		x2	x6	x2	x6





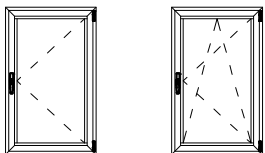
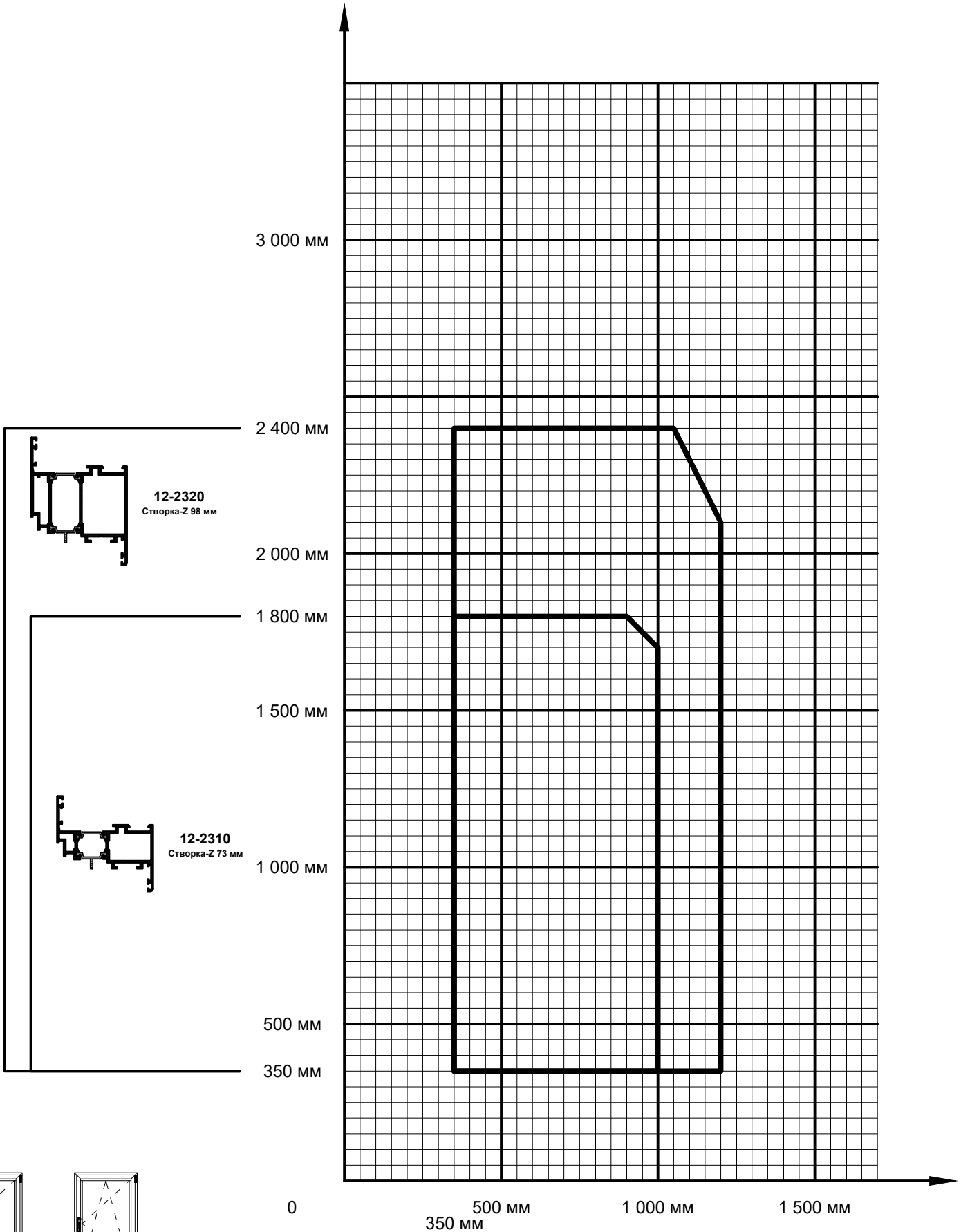

$h \leq 1200$

$1200 < h \leq 2400$

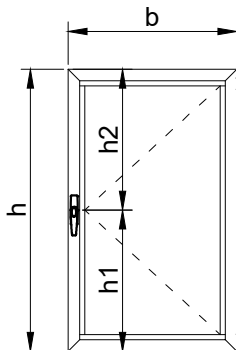
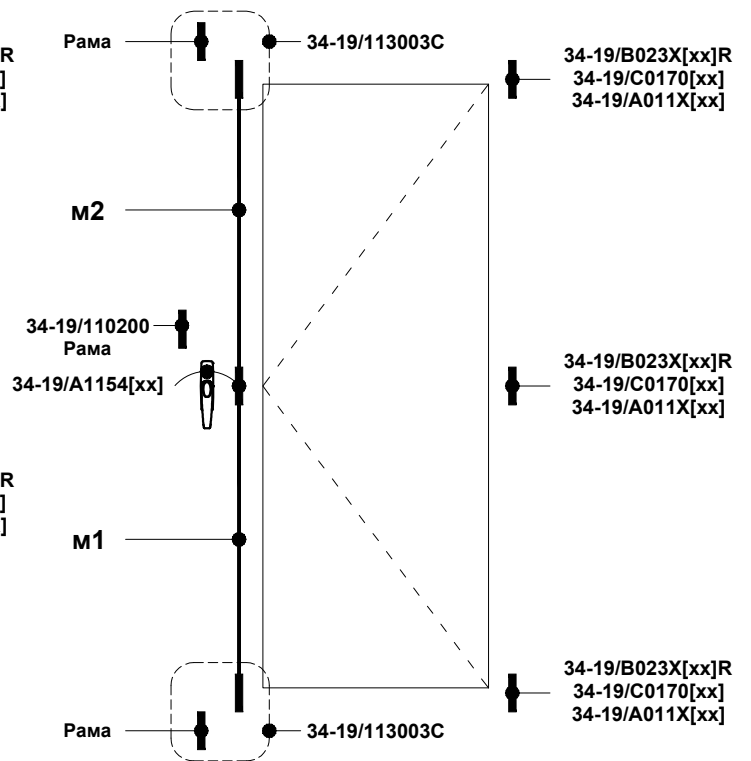
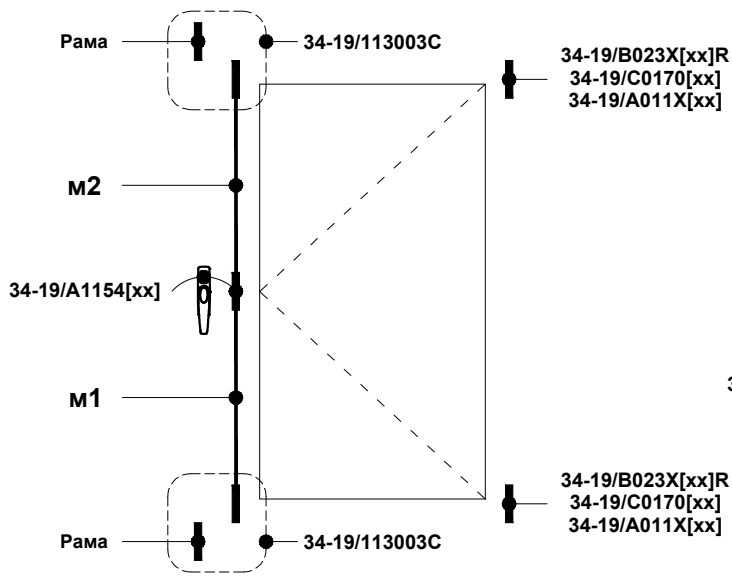

Мувиль	Длина, мм
м1	h1 - 82
м2	h2 - 190

Вес створки, кг	Навес	Ручка	Запорная часть		Ограничения	
			$h \leq 1200$	$1200 < h \leq 2400$	Ширина	Высота
$\leq 50$	34-19/B023X[xx]R	34-19/A1154[xx]	34-19/113003C x2	34-19/113003C x2 34-19/110200	см. диаграмму	
$\leq 60$	34-19/C0170[xx]					
$\leq 90$	34-19/A011X[xx]					



$h \leq 1200$

$1200 < h \leq 2400$

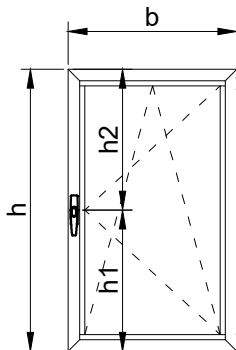
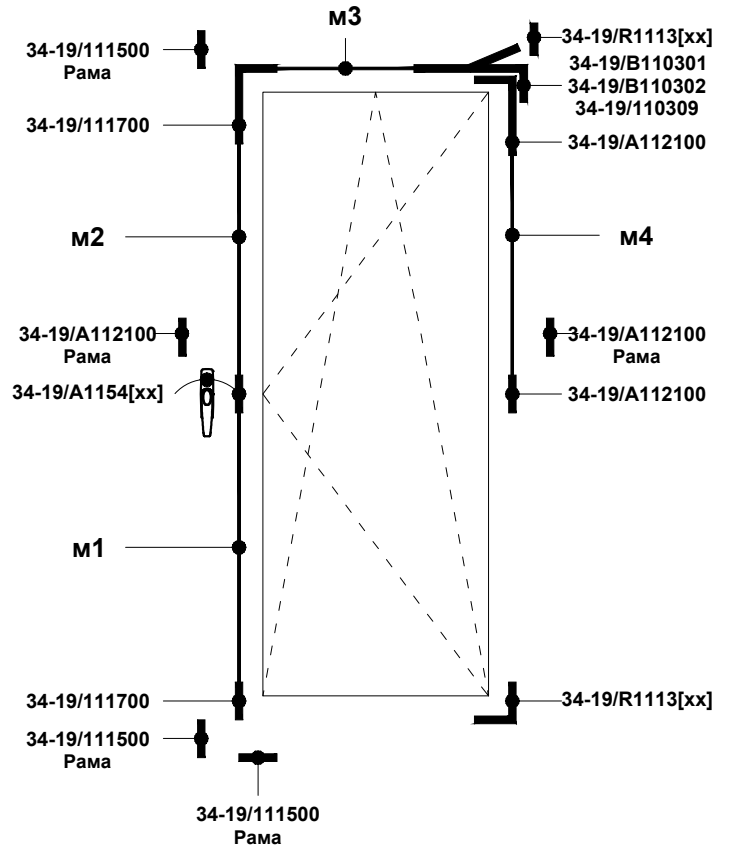
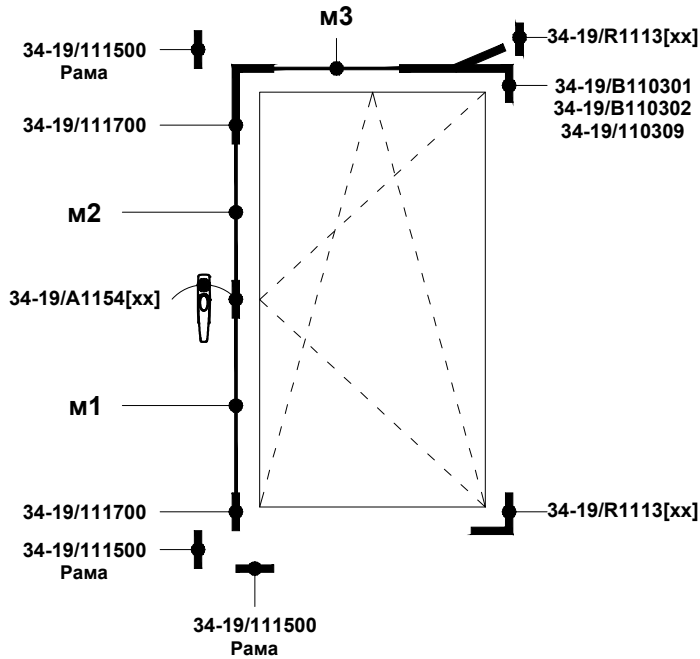

Мувиль	Артикул	Длина, мм
м1		h1 - 82
м2		h2 - 190
м3	34-19/B110301	b - 495
	34-19/B110302	b - 373
	34-19/110309	b - 309
м4		h/2 - 205

Высота (h), мм	Ширина (b), мм			Ручка
	$350 \leq b \leq 450$	$450 < b \leq 750$	$750 < b \leq 1200$	
$h \leq 1200$	34-19/110309 x1 34-19/111700 x1 34-19/111500 x1 34-19/R1113[xx] x1	34-19/B110302 x1 34-19/111700 x1 34-19/111500 x1 34-19/R1113[xx] x1	34-19/B110301 x1 34-19/111700 x1 34-19/111500 x1 34-19/R1113[xx] x1	34-19/A1154[xx]
$1200 < h \leq 2400$	34-19/110309 x1 34-19/111700 x1 34-19/111500 x1 34-19/R1113[xx] x1 34-19/A112100 x1	34-19/B110302 x1 34-19/111700 x1 34-19/111500 x1 34-19/R1113[xx] x1 34-19/A112100 x1	34-19/B110301 x1 34-19/111700 x1 34-19/111500 x1 34-19/R1113[xx] x1 34-19/A112100 x1	



12-2310 12-2320



12-2110



12-2130



12-2152



12-2210



12-2220

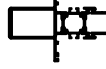

12-2221



12-2410

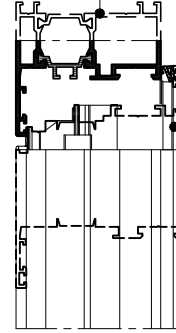
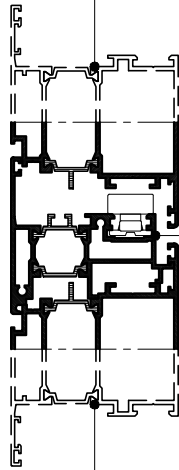

33-2064

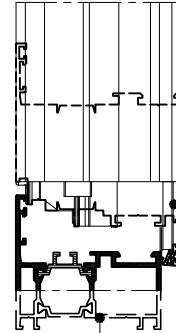

33-2064

12-2310 12-2320

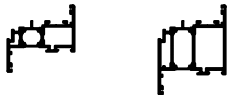

12-2110



12-2130



12-2152



12-2210



12-2220



12-2221

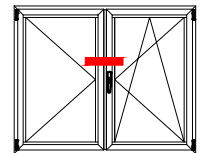

Шпингалет				Планка ответная			Примыкающий элемент
Внешний вид	Артикул	Наименование	Крепление	Внешний вид	Артикул	Крепление	Артикул
	34-19/111601	Комплект шпингалетов шульповых	В комплекте			В комплекте	12-2110 12-2130 12-2152 12-2210 12-2220



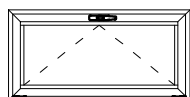
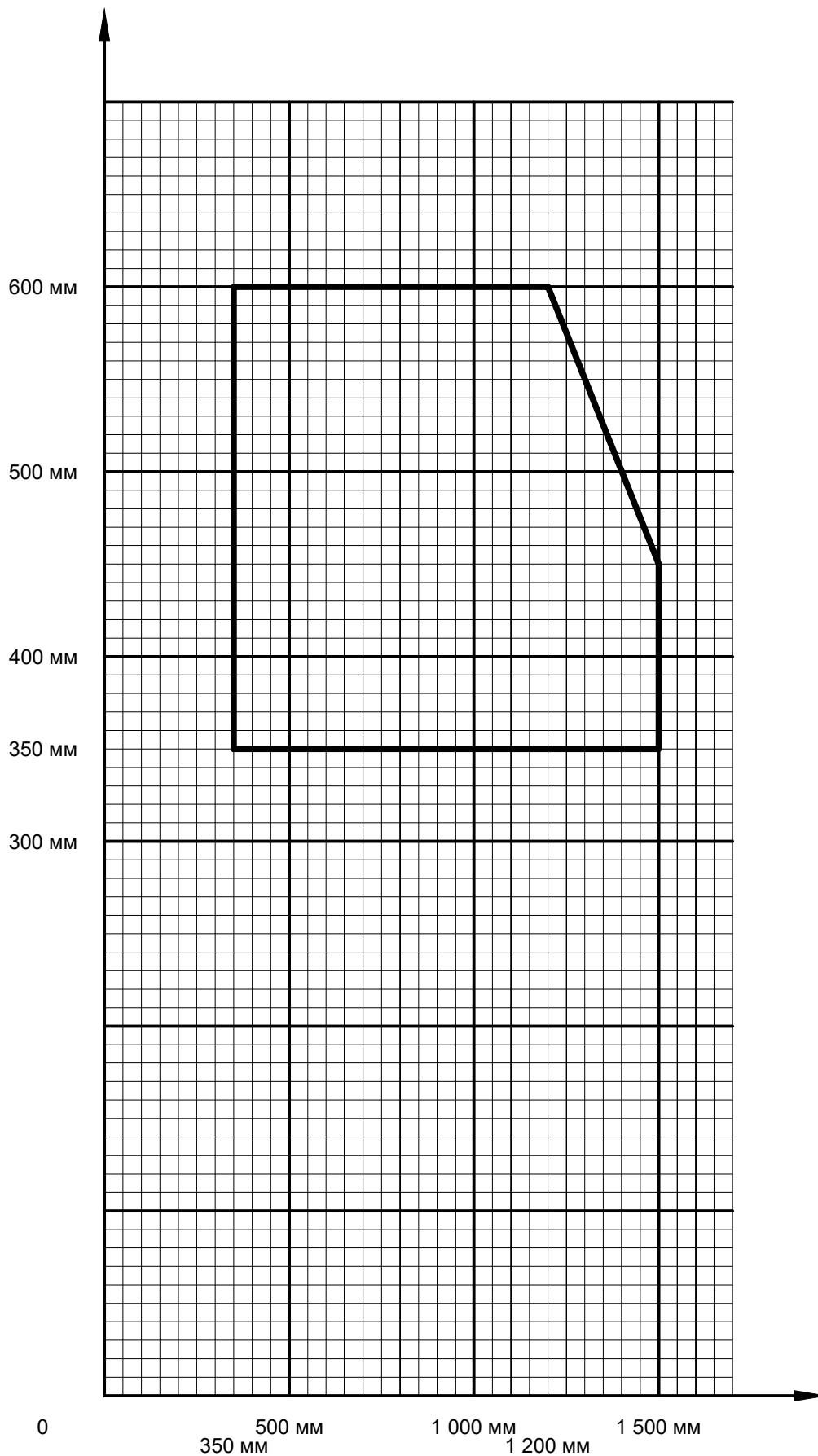
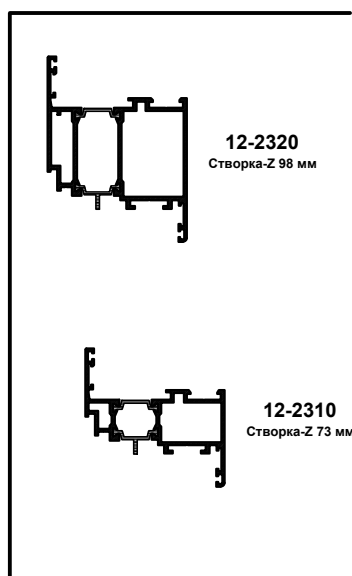

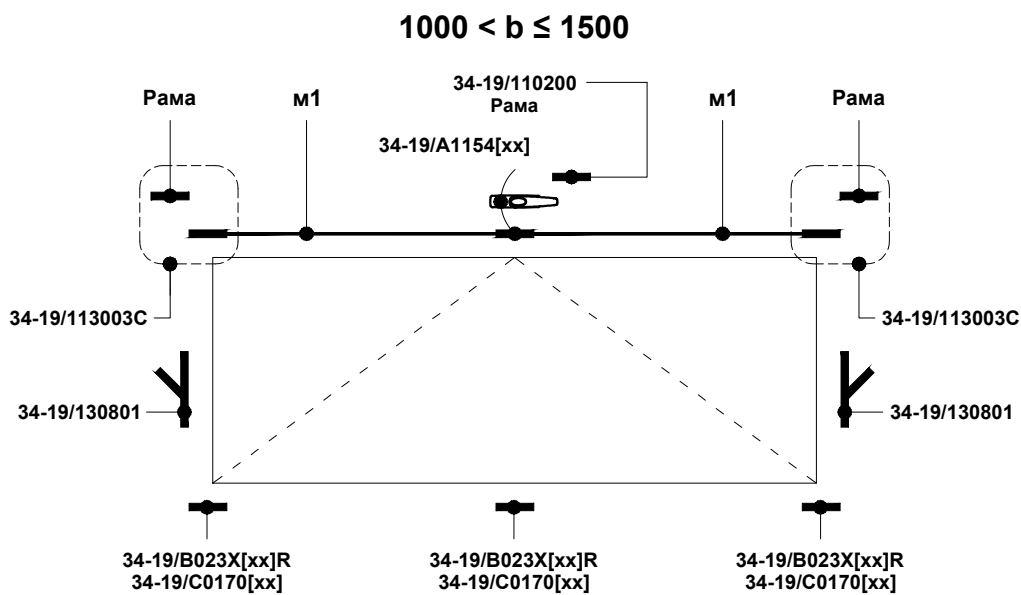
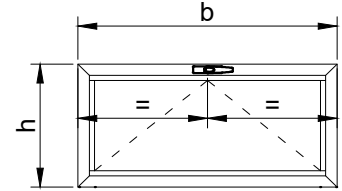
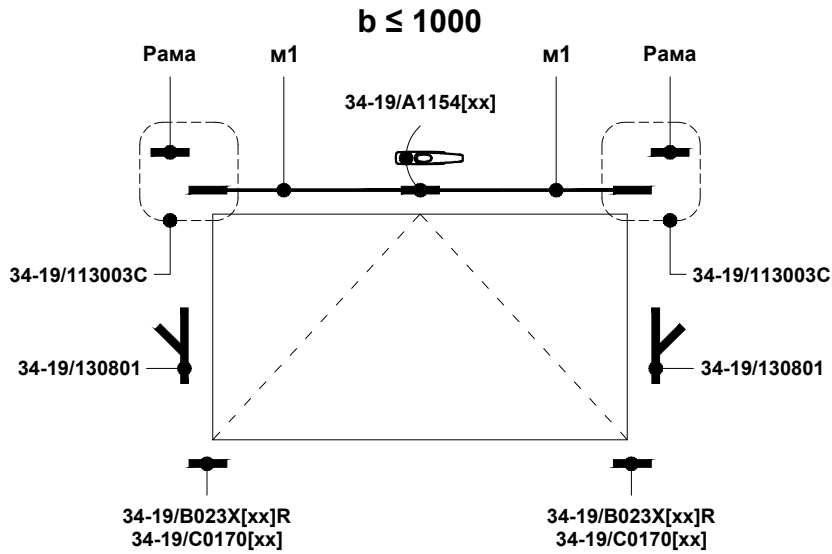

Мувиль	Длина, мм
м1	$h/2 - 205$

Вес створки, кг	Навес	Ограничитель открывания	Ручка	Запорная часть		Ограничения	
				$b \leq 1000$	$1000 < b \leq 1500$	Ширина	Высота
$\leq 15$	34-19/B023X[xx]R	34-19/130801 x2	34-19/A1154[xx]	34-19/113003C x2	34-19/113003C x2	см. диаграмму	
$\leq 30$	34-19/C0170[xx]						



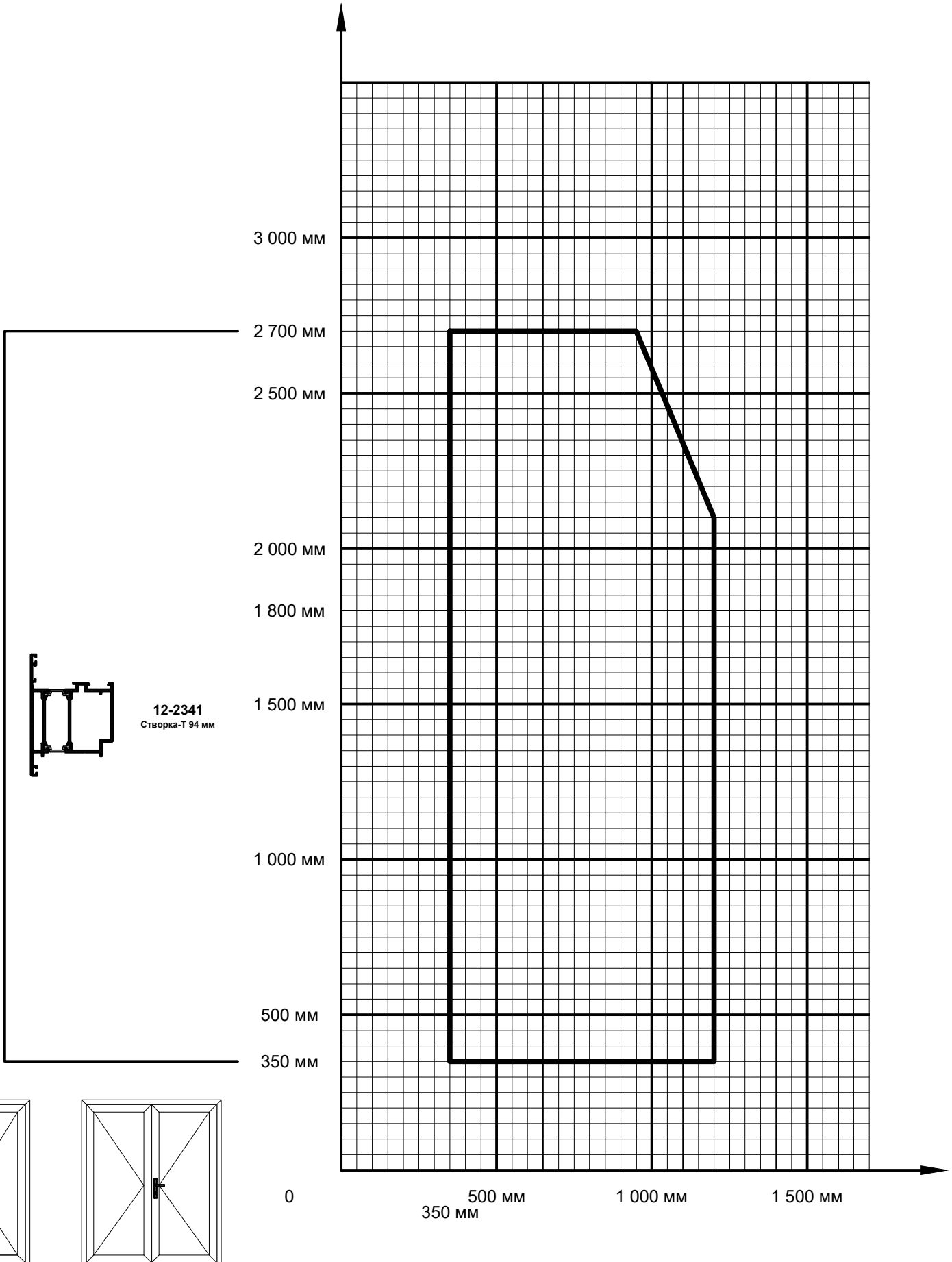

12-2341

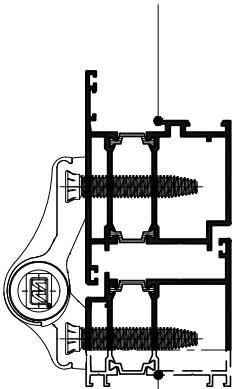

12-2341

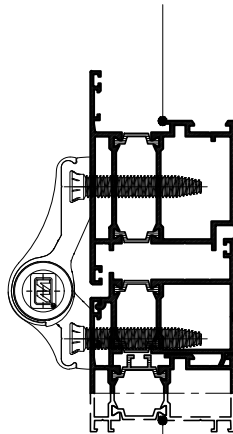

12-2431

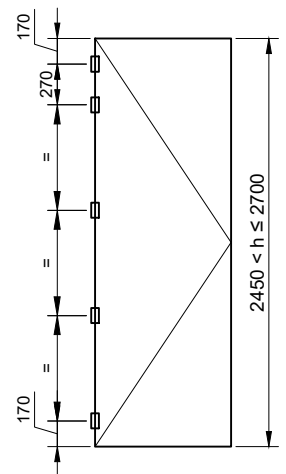
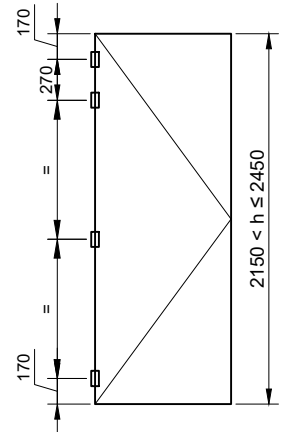
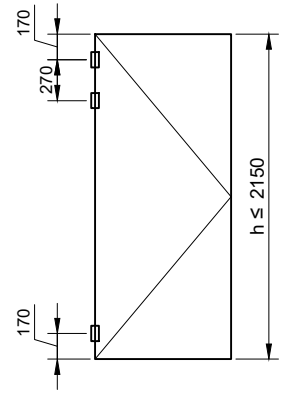

12-2122



12-2141



12-2110



12-2130



12-2152



12-2210



12-2221



12-2220

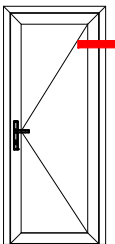
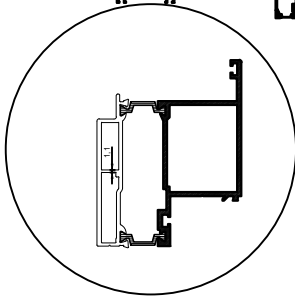

Навес			Крепление		
Внешний вид	Артикул	Наименование	Внешний вид	Артикул	Наименование
	34-20/MX8010456[x]	Навес двухчастный WLINE-MX	x4	34-20/WX80SD4980	Крепление для навеса WALA
	34-20/WX8010456[x]	Навес двухчастный WLINE-WX	x4	34-20/WX80SD4980	Крепление для навеса WALA
	34-25/M701<x>E000	Навес дверной Dr. Hahn		34-25/VP02A0000	Комплект крепления для навеса Dr. Hahn





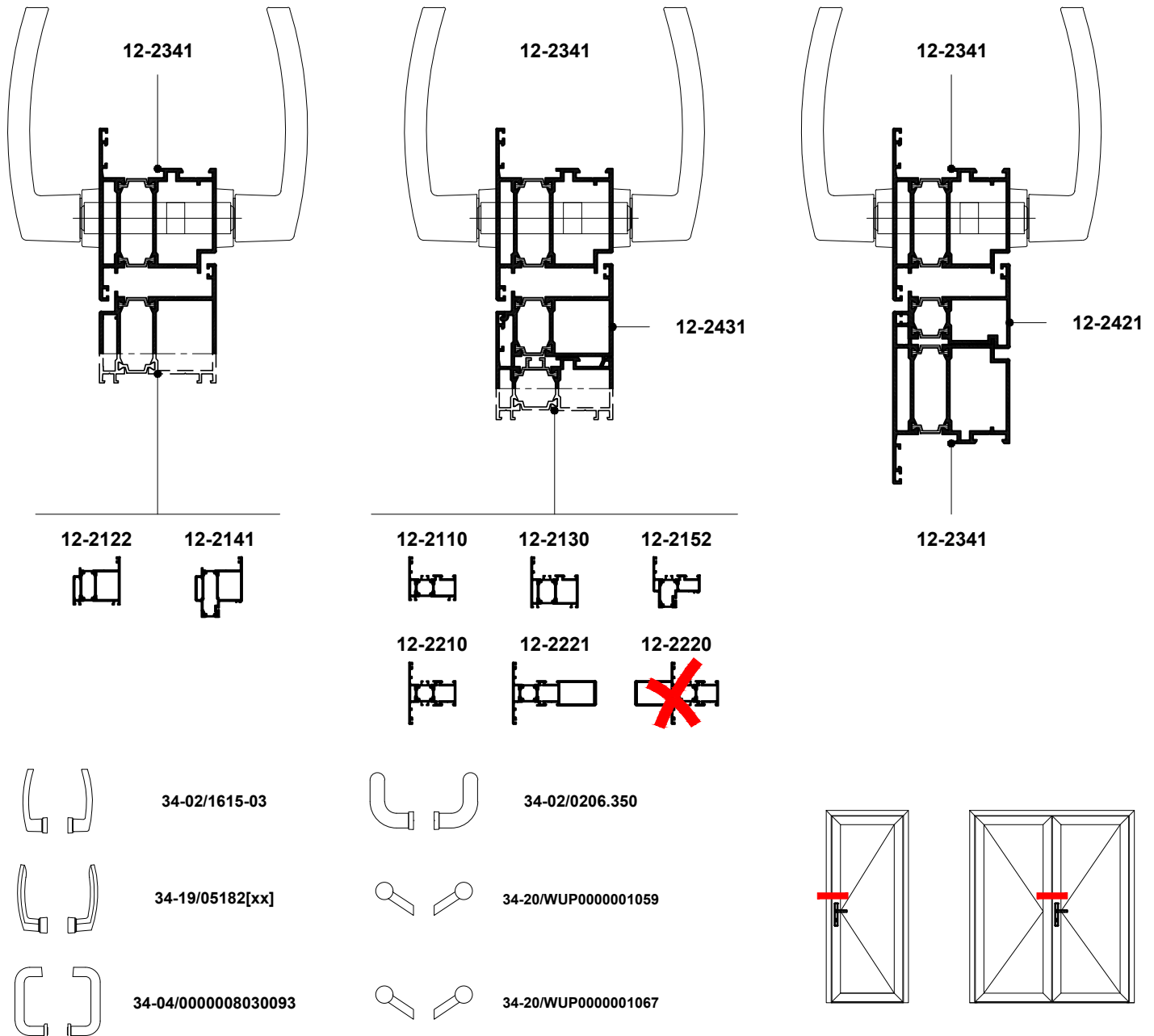

Ручка				Накладка			Цилиндр фигурный
Внешний вид	Артикул	Наименование	Крепление	Внешний вид	Артикул	Крепление	Артикул
	34-02/1615-03	Гарнитура нажимной 32/92/66-75	46-DIN966 A2 M5x70 TX25 x3	-	-	-	34-01/0003/3555
	34-19/05182[xx]	Комплект ручек нажимных POLARIS	46-DIN965 Zn M5x16 TX25 x8 40-ART1021 A2 M5x11,5 x8		34-19/0508053[xx] x2	41-DIN7981C A2 3,9x13 TX15 x4	34-01/0003/3050
	34-04/0000008030093	Комплект ручек нажимных с накладками	В комплекте	В комплекте	В комплекте	В комплекте	34-01/0003/3050
	34-02/0206.350	Комплект ручек дверных стационарных	В комплекте		34-19/0508053[xx] x2	41-DIN7981C A2 3,9x13 TX15 x4	34-01/0003/3050
	34-20/WUP0000001059	Комплект ручек 1200-1400 мм с креплением	В комплекте		34-23/0000417611	43-DIN7982C A2 3,9x13 TX15 x4	34-01/0003/3555
	34-20/WUP0000001067	Комплект ручек 300-500 мм с креплением	В комплекте		34-23/0000417611	43-DIN7982C A2 3,9x13 TX15 x4	34-01/0003/3555



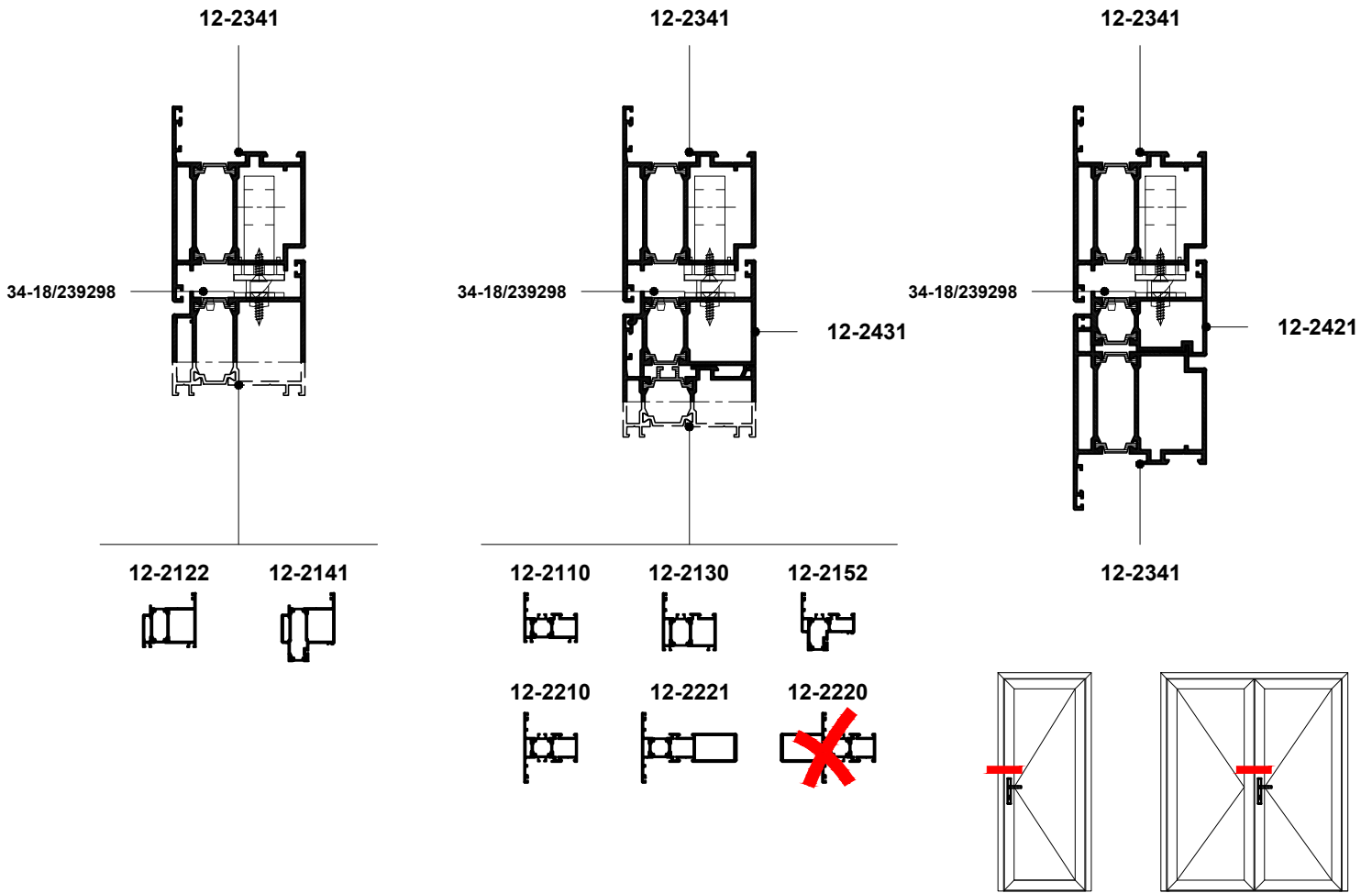

Ручка	Замок				Планка ответная		
	Внешний вид	Артикул	Наименование	Крепление	Внешний вид	Артикул	Крепление
<b>Нажимные</b> <b>34-02/1615-03</b> Гарнитура нажимной 32/92/66-75 <b>34-19/05182[xx]</b> Комплект ручек нажимных POLARIS <b>34-04/0000008030093</b> Комплект ручек нажимных с накладками		34-22/3469528	Замок клиновидный KFV RES 49N 24x6/92/35	43-DIN7982C A2 3,9x16 TX15 x2		34-22/3477532 лев 34-22/3477533 прав	34-18/239298 43-DIN7982C A2 3,9x16 TX15 x3
		34-04/1100000009810	Замок клиновидный 24x3/92/35	34-04/1100000009939 43-DIN7982C A2 3,9x16 TX15 x2	-	<b>В комплекте</b>	
		34-22/3488093	Замок M3K KFV AS2300 24x6x1880-2170/35/92	43-DIN7982C A2 3,9x16 TX15 x10		34-22/3478553 лев 34-22/3478552 прав	34-18/239298 43-DIN7982C A2 3,9x16 TX15 x10
		34-22/3492892	Замок M3K KFV AS2750 24x6x1880-2170/35/92	43-DIN7982C A2 3,9x16 TX15 x10		34-22/3478553 лев 34-22/3478552 прав	34-18/239298 43-DIN7982C A2 3,9x16 TX15 x10
<b>Стационарные</b> <b>34-02/0206.350</b> Комплект ручек дверных стационарных <b>34-20/WUP0000001059</b> Комплект ручек 1200-1400 мм с креплением <b>34-20/WUP0000001067</b> Комплект ручек 300-500 мм с креплением		34-22/3469528	Замок клиновидный KFV RES 49N 24x6/92/35	43-DIN7982C A2 3,9x16 TX15 x2		34-22/3477532 лев 34-22/3477533 прав 34-22/3493198	34-18/239298 43-DIN7982C A2 3,9x16 TX15 x3
		34-04/1100000009820	Замок роликовый 24x3/92/35	34-04/1100000009939 43-DIN7982C A2 3,9x16 TX15 x2	-	<b>В комплекте</b>	
		34-22/3488093	Замок M3K KFV AS2300 24x6x1880-2170/35/92	43-DIN7982C A2 3,9x16 TX15 x10		34-22/3478553 лев 34-22/3478552 прав 34-22/3493198	34-18/239298 43-DIN7982C A2 3,9x16 TX15 x10



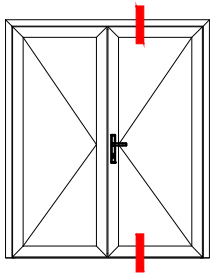
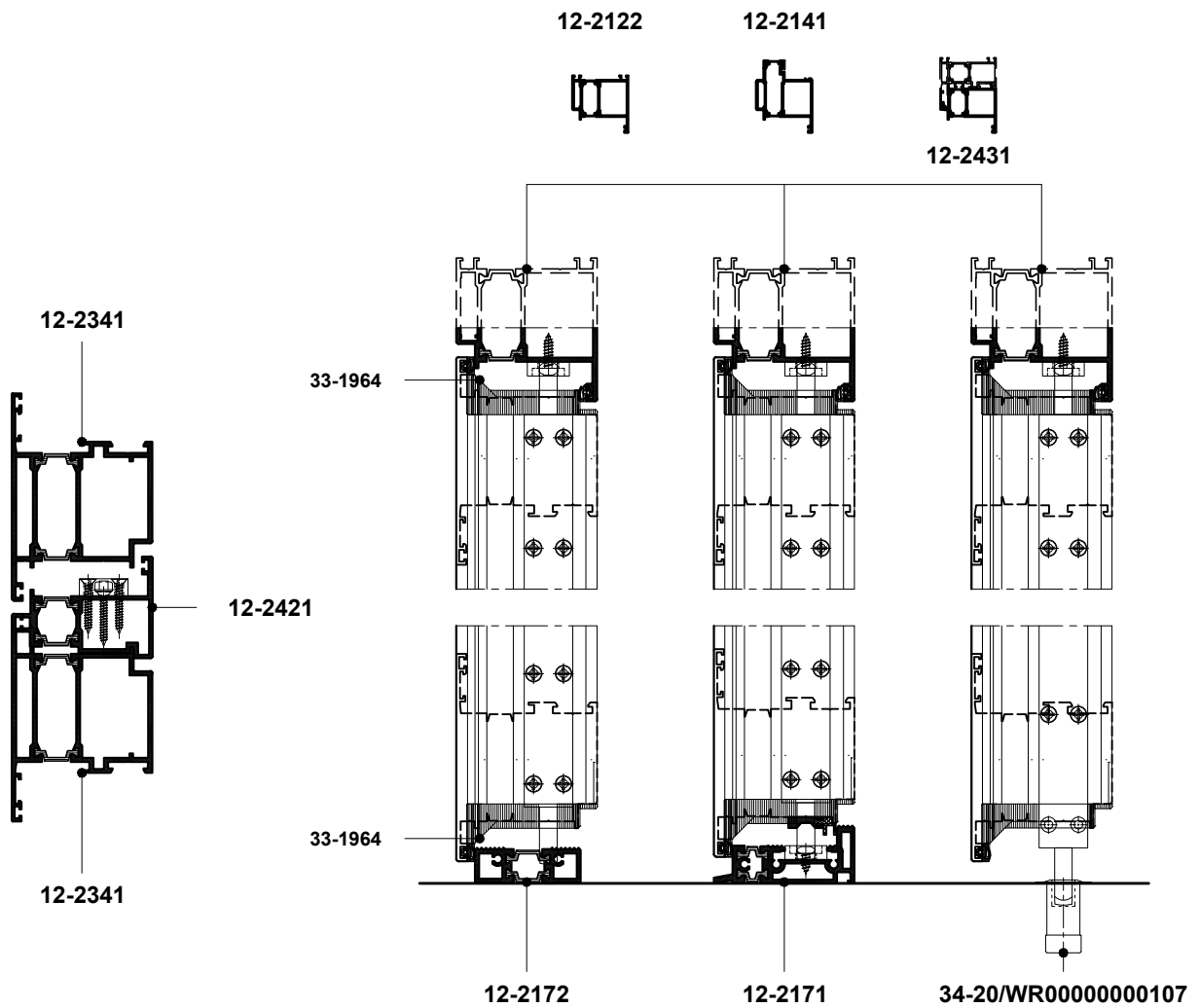

Шпингалет				Планка ответная			Примыкающий элемент
Внешний вид	Артикул	Наименование	Крепление	Внешний вид	Артикул	Крепление	Артикул
	34-21/8019005M2500H	Шпингалет 22x8x225	В комплекте		34-03/3012.20	В комплекте	12-2122 12-2141 12-2431 12-2171
	34-21/8019005M2500H	Шпингалет 22x8x225	В комплекте	-	-	-	12-2172
	34-21/8019005M2500H	Шпингалет 22x8x225	В комплекте		34-20/WR00000000107	-	Пол



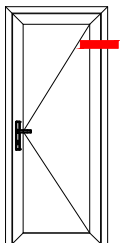
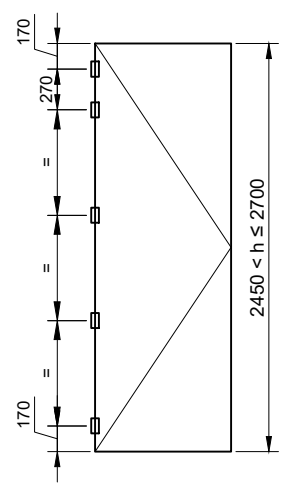
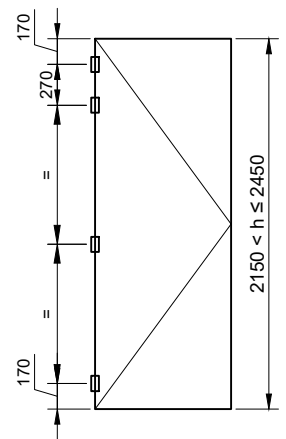
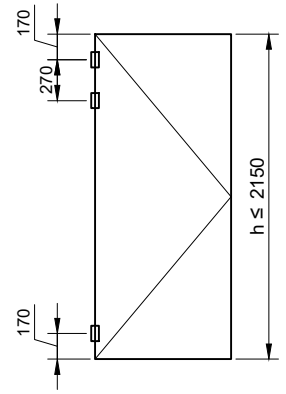
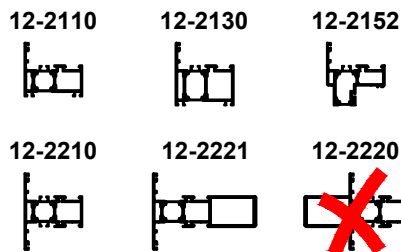
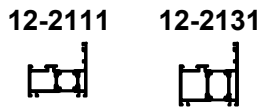
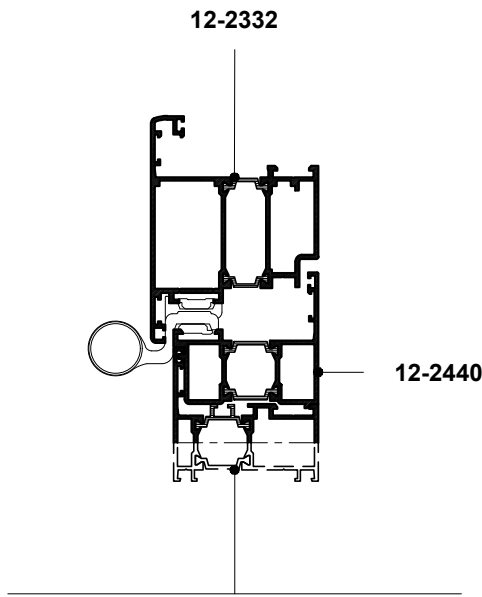
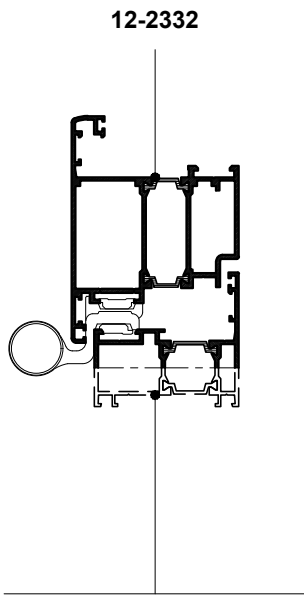

Навес			Крепление
Внешний вид	Артикул	Наименование	
	34-19/A011X[xx]	Навес двухчастный TAURUS	В комплекте



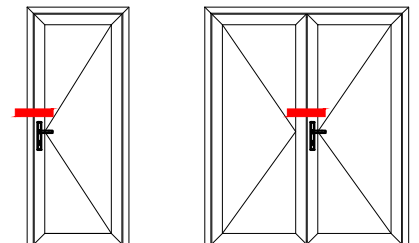
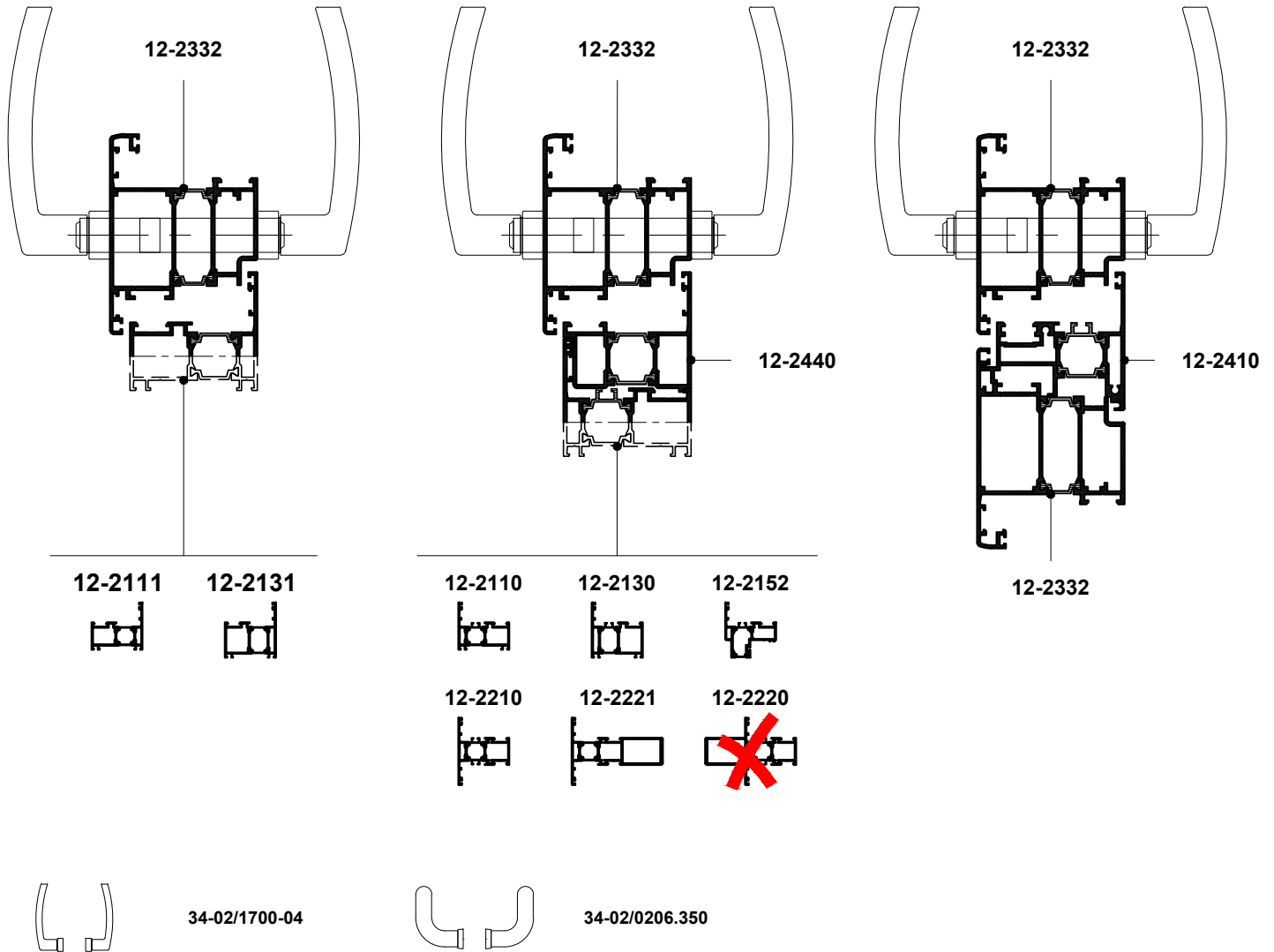

Ручка				Накладка			Цилиндр фигурный
Внешний вид	Артикул	Наименование	Крепление	Внешний вид	Артикул	Крепление	Артикул
	34-02/1700-04	Гарнитур нажимной 24/92/76-84	46-DIN966 A2 M5x80 TX25 x3	-	-	-	34-01/0003/3565
	34-02/0206.350	Комплект ручек дверных стационарных	В комплекте		34-14/00001474	43-DIN7982C A2 3,9x13 TX15 x4	34-01/0003/3565



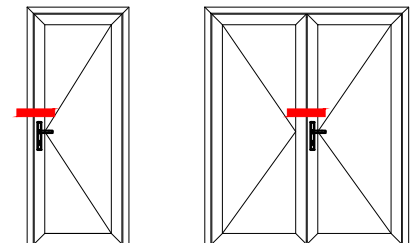
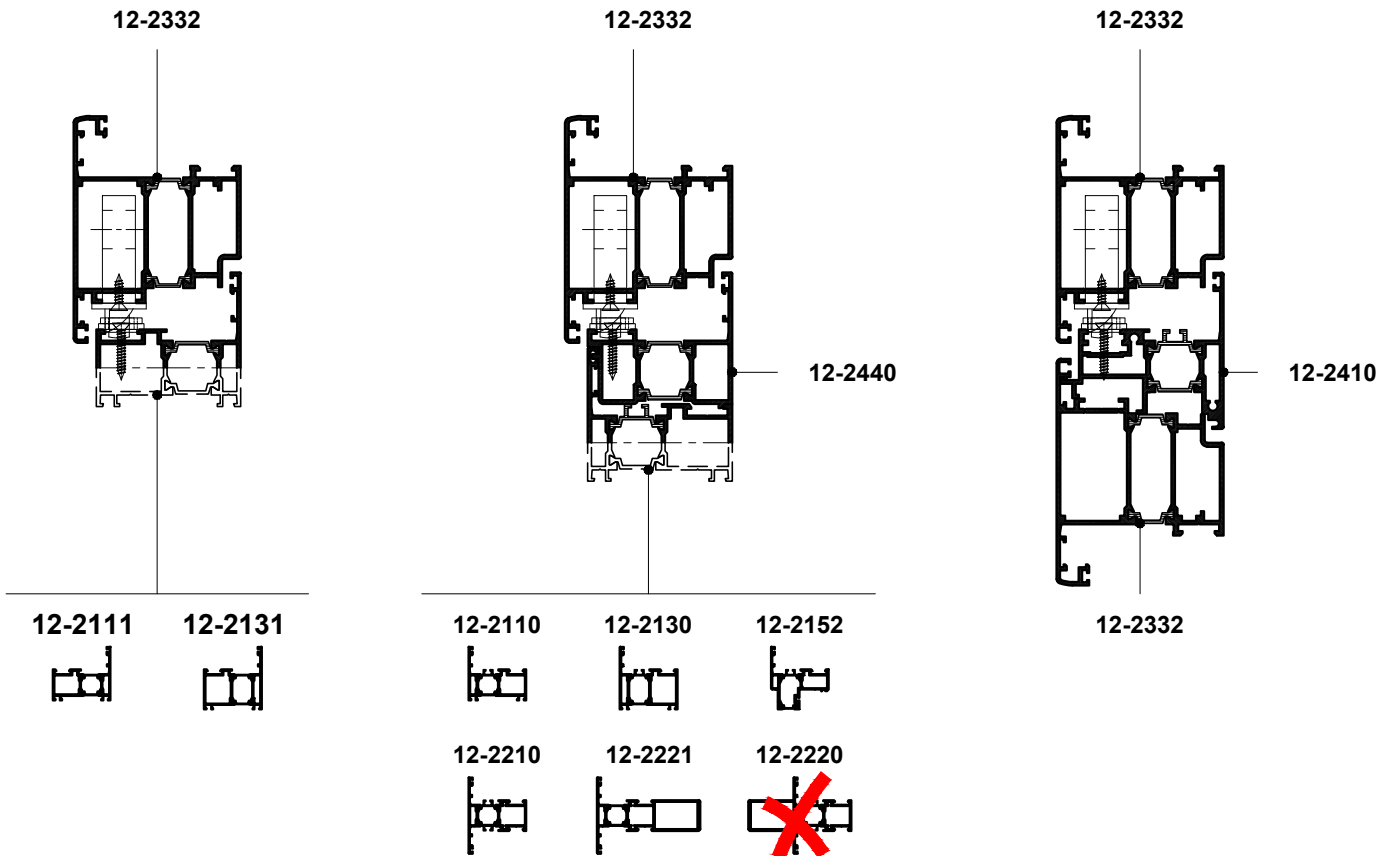

Замок				Планка ответная			Ручка
Внешний вид	Артикул	Наименование	Крепление	Внешний вид	Артикул	Крепление	
	34-04/1100000009810	Замок клиновыи 24x3/92/35	34-04/1100000009939 43-DIN7982C A2 3,9x16 TX15 x2		34-16/CT7777	43-DIN7982C A2 3,9x25 TX15 x3	34-02/1700-04 Гарнитура нажимной 24/92/76-84
	34-04/1100000009820	Замок роликовый 24x3/92/35	34-04/1100000009939 43-DIN7982C A2 3,9x16 TX15 x2		34-16/CT7777	43-DIN7982C A2 3,9x25 TX15 x3	34-02/0206.350 Комплект ручек дверных стационарных



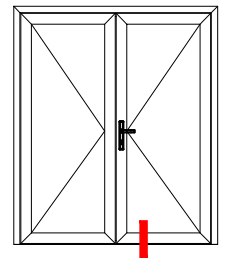
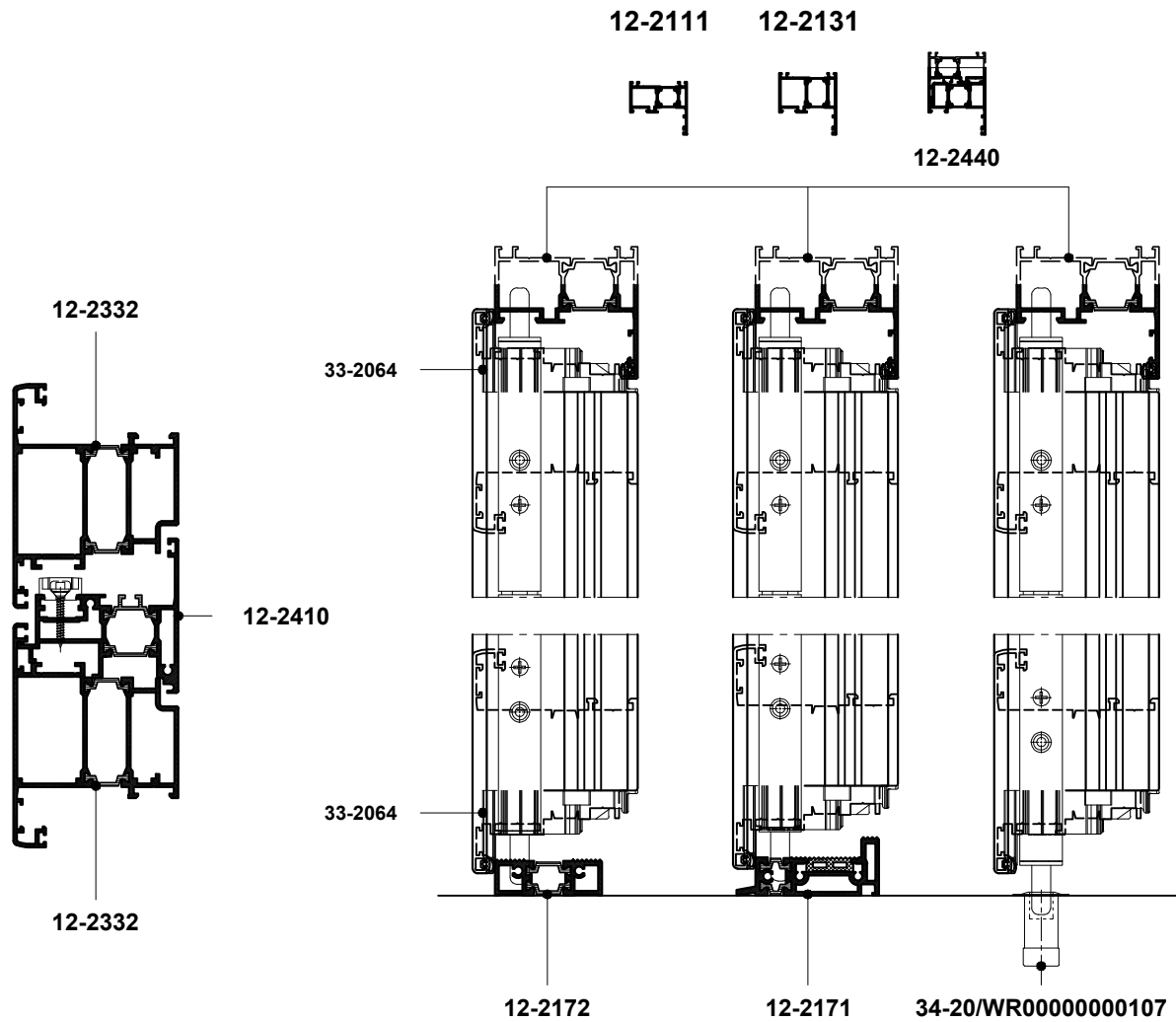

Шпингалет				Планка ответная			Примыкающий элемент
Внешний вид	Артикул	Наименование	Крепление	Внешний вид	Артикул	Крепление	Артикул
	34-19/052402[xx]	Шпингалет 19x8x220	В комплекте	-	-	-	12-2111 12-2131 12-2172 12-2171 12-2440
					34-20/WR00000000107	-	Пол



12-2310



12-2320

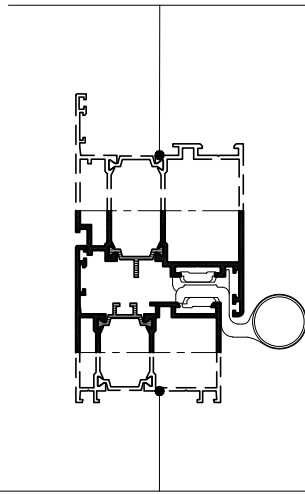

12-2110



12-2130



12-2152



12-2210



12-2220



12-2221

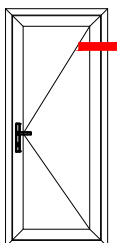
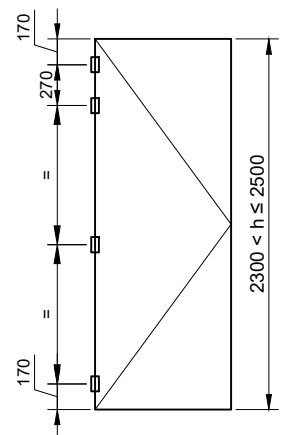
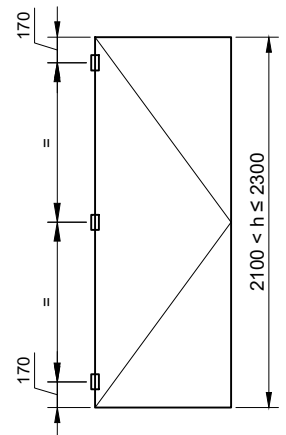
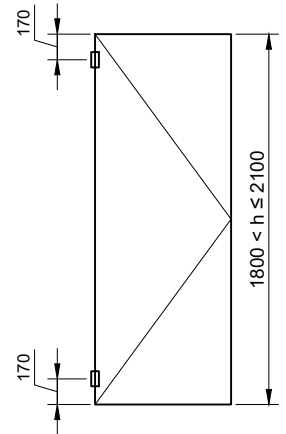

Навес			Ограничения		
Внешний вид	Артикул	Наименование	Ширина створки	Высота створки	Вес створки
	34-19/A011X[xx]	Навес двухчастный TAURUS	≤ 1200	≤ 2500	90 кг





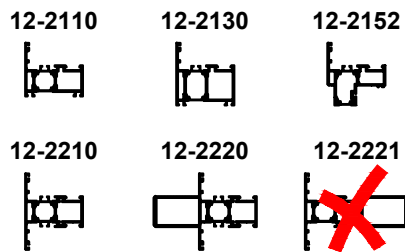
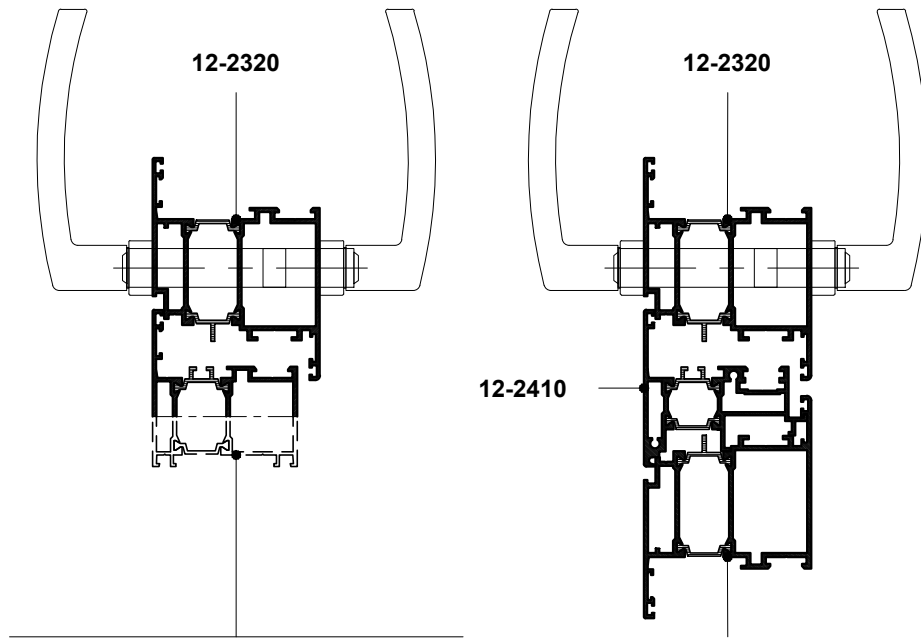

12-2320



34-02/1700-04

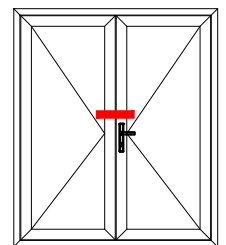
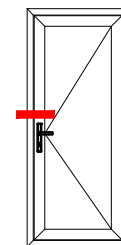

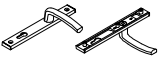
Ручка				Накладка			Цилиндр фигурный
Внешний вид	Артикул	Наименование	Крепление	Внешний вид	Артикул	Крепление	Артикул
	34-02/1700-04	Гарнитура нажимной 24/92/76-84	46-DIN966 A2 M5x80 TX25 x3	-	-	-	34-01/0003/3565



12-2320

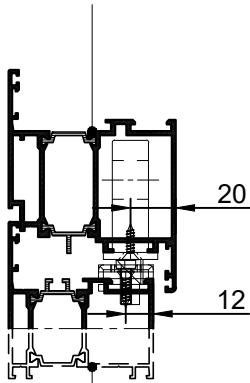

12-2320

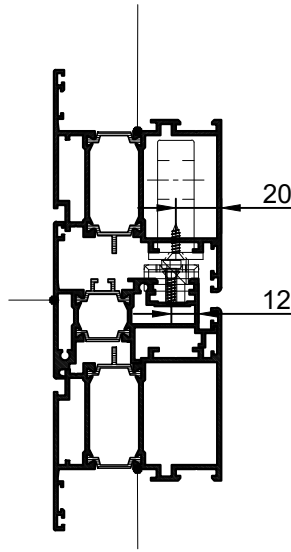

12-2110



12-2130



12-2152



12-2210



12-2220

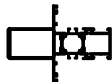

12-2221



12-2320

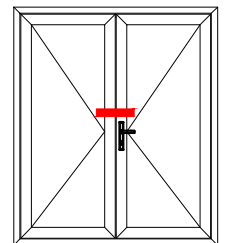
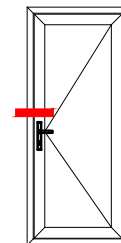

Замок				Планка ответная			Ручка
Внешний вид	Артикул	Наименование	Крепление	Внешний вид	Артикул	Крепление	
	34-22/3506068	Замок M3K KFV AS2750 24x3x2130-2400/35/92	43-DIN7982C A2 3,9x16 TX15 x10		34-03/3093.00 34-22/3478743 доп x2	43-DIN7982C A2 3,9x16 TX15 x6	34-02/1700-04 Гарнитура нажимной 24/92/76-84
					34-03/3093.00 34-22/3478743 доп x2		



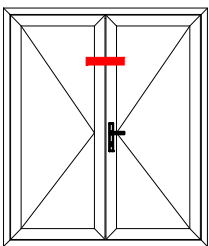
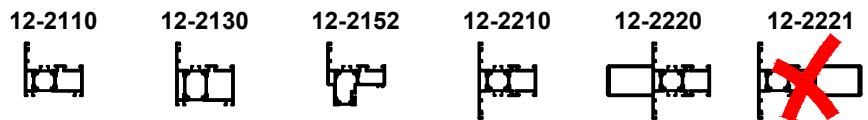
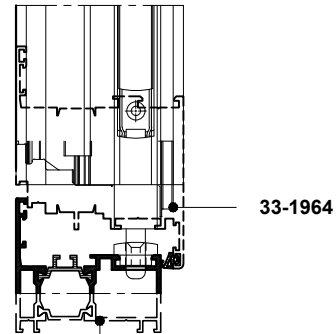
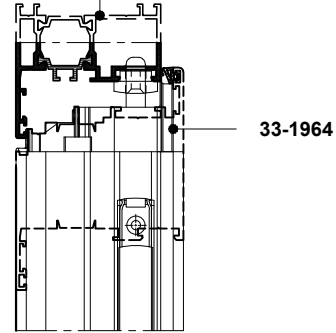
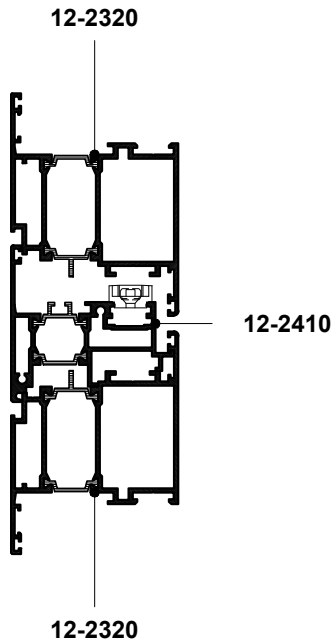
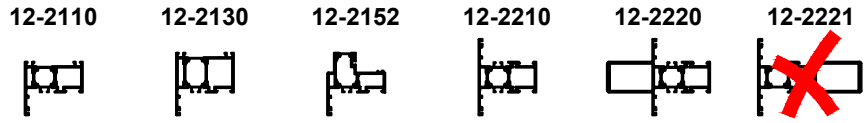

Шпингалет				Планка ответная			Примыкающий элемент
Внешний вид	Артикул	Наименование	Крепление	Внешний вид	Артикул	Крепление	Артикул
	34-19/052401[xx]	Шпингалет 19x8x140	В комплекте		34-19/0524020	В комплекте	12-2110 12-2130 12-2152 12-2210 12-2220

