



СОДЕРЖАНИЕ

- | | |
|------------|--|
| 01. | Содержание, оглавление, термины |
| 02. | Профили |
| 03. | Уплотнители, пластиковые адаптеры и вставки,
термомосты |
| 04. | Комплектующие и аксессуары |
| 05. | Сечения |
| 06. | Узлы |
| 07. | Остекление |
| 08. | Фурнитура |
| 09. | Сборка |



Сечение	Артикул Наименование	I_x см ⁴	W_x см ³	S см ²
		I_y см ⁴	W_y см ³	P мм
	12-3110 Рама 59 мм	33,55 8,35	8,26 2,20	4,365 387
	12-3111 Рама 59 мм для створки-T	33,55 8,35	8,26 2,20	4,365 387

Профиль	Сухари		Химия	Комплектующие			
	Чаша I	Чаша II		Сбивка угла на прессе		Сборка угла на штифтах	
				Чаша I	Чаша II	Чаша I	Чаша II
Соединение L							
12-3110	20-0200/0059	20-0200/0266	80-2002 9 мл 80-3002 2 мл 80-4001 2 мл 80-9001 1 мл	31-0010		40-DIN1481 A2 D5x12 x2 31-0010	40-DIN1481 A2 D5x12 x2
12-3111	20-0200/0266	20-0200/0059	80-2002 9 мл 80-3002 2 мл 80-4001 2 мл		31-0010	40-DIN1481 A2 D5x12 x2	40-DIN1481 A2 D5x12 x2 31-0010
Соединение T							
12-3110	20-1051/0207	20-1261/0207	80-2002 5 мл 80-3002 1 мл 80-4001 2 мл			40-DIN1481 A2 D3x12 x2 40-DIN916 A2 M5x6 HEX2,5	40-DIN1481 A2 D5x12 x2 42-DIN7504M A2 4,2x50 TX20



Сечение	Артикул Наименование	I_x см ⁴	W_x см ³	S см ²
		I_y см ⁴	W_y см ³	P мм
	<p>12-3130 Рама 69 мм</p>	$\frac{38,68}{14,63}$	$\frac{9,50}{3,42}$	$\frac{5,026}{427}$
	<p>12-3131 Рама 69 мм для створки-Т</p>	$\frac{38,68}{14,63}$	$\frac{9,50}{3,42}$	$\frac{5,026}{427}$

Профиль	Сухари		Химия	Комплекующие			
	Чаша I	Чаша II		Сбивка угла на прессе		Сборка угла на штифтах	
				Чаша I	Чаша II	Чаша I	Чаша II
Соединение L							
12-3130	20-0300/0059	20-0300/0266		31-0010		40-DIN1481 A2 D5x12 x2 31-0010	40-DIN1481 A2 D5x12 x2
12-3131	20-0300/0266	20-0300/0059			31-0010	40-DIN1481 A2 D5x12 x2	40-DIN1481 A2 D5x12 x2 31-0010
Соединение T							
12-3130	20-1051/0307	20-1261/0307				40-DIN1481 A2 D3x12 x2 40-DIN916 A2 D5x12 M5x6 HEX2,5	40-DIN1481 A2 D5x12 x2 42-DIN7504M A2 4,2x50 TX20



Сечение			Артикул	I_x см ⁴	W_x см ³	S см ²
			Наименование	I_y см ⁴	W_y см ³	P мм
			<p>12-3132 Рама 120 мм</p>			

Профиль	Сухари		Химия	Комплектующие			
	Чаша I	Чаша II		Сбивка угла на прессе		Сборка угла на штифтах	
				Чаша I	Чаша II	Чаша I	Чаша II
Соединение Т							
12-3132	20-1051/0817	20-1261/0817				40-DIN1481 A2 D3x12 x2 40-DIN916 A2 M5x6 HEX2,5	40-DIN1481 A2 D5x12 x2 42-DIN7504M A2 4,2x50 TX20



Сечение		Артикул Наименование	$\frac{I_x}{I_y}$ см ⁴	$\frac{W_x}{W_y}$ см ³	$\frac{S}{P}$ см ² мм
		<p>12-3122 Рама 65 мм для створки-Т</p>	$\frac{40,73}{16,65}$	$\frac{10,52}{4,34}$	$\frac{5,492}{409}$

Профиль	Сухари		Химия	Комплектующие			
	Чаша I	Чаша II		Сбивка угла на прессе		Сборка угла на штифтах	
				Чаша I	Чаша II	Чаша I	Чаша II
Соединение L							
12-3122	20-0300/0059	20-0370/0296				40-DIN1481 A2 D5x12 x2	40-DIN1481 A2 D5x12 x2



Сечение				Артикул	I_x см ⁴	W_x см ³	S см ²
				Наименование	I_y см ⁴	W_y см ³	P мм
				12-3141	30,51	8,31	1,954
				Рама створки-Т в витраж	8,56	2,25	358
				12-3152	29,73	7,10	4,673
				Рама в витраж	11,27	2,84	425
Профиль	Сухари		Химия	Комплекующие			
	Чаша I	Чаша II		Сбивка угла на прессе		Сборка угла на штифтах	
				Чаша I	Чаша II	Чаша I	Чаша II
Соединение L							
12-3141	20-0300/0059	20-0370/0296				40-DIN1481 A2 D5x12 x2	40-DIN1481 A2 D5x12 x2
12-3152	20-0130/0059	20-0130/0266		31-0010		40-DIN1481 A2 D5x12 x2 31-0010	40-DIN1481 A2 D5x12 x2



Сечение				Артикул Наименование		I_x см ⁴ I_y см ⁴	W_x см ³ W_y см ³	S см ² P мм
				12-3160 Рама 78 мм створки скрытой				0 0
				12-3171 Порог 26 мм				0 0
				12-3172 Порог 16 мм		$\frac{10,38}{0,711}$	$\frac{3,65}{0,84}$	$\frac{2,5}{90}$
Профиль	Сухари		Химия	Комплектующие				
	Чаша I	Чаша II		Сбивка угла на прессе		Сборка угла на штифтах		
				Чаша I	Чаша II	Чаша I	Чаша II	
Соединение L								
12-3160	20-0200/0059	20-0200/0266		31-0010		40-DIN1481 A2 D5x12 x2 31-0010	40-DIN1481 A2 D5x12 x2	
Соединение T								
12-3160	20-1051/0207	20-1261/0207				40-DIN1481 A2 D3x12 x2 40-DIN916 A2 M5x6 HEX2,5	40-DIN1481 A2 D5x12 x2 42-DIN7504M A2 4,2x50 TX20	
12-3171		32-1874					43-DIN7982C A2 3,9x16 TX15 x4	
12-3172	32-1874					43-DIN7982C A2 3,9x16 TX15 x2	43-DIN7982C A2 3,9x16 TX15 x2	



Сечение				Артикул	I_x см ⁴	W_x см ³	S см ²
				Наименование	I_y см ⁴	W_y см ³	P мм
				<p>12-3210 Импост 84 мм</p>	<p>39,0 15,71</p>	<p>9,22 3,74</p>	<p>5,331 464</p>
Профиль	Сухари		Химия	Комплекующие			
	Чаша I	Чаша II		Сбивка угла на прессе		Сборка угла на штифтах	
				Чаша I	Чаша II	Чаша I	Чаша II
Соединение L							
12-3210	20-0200/0059	20-0200/0266		31-0010	x2	40-DIN1481 A2 D5x12 x2 31-0010 x2	40-DIN1481 A2 D5x12 x2
Соединение T							
12-3210	20-1051/0207	20-1261/0207				40-DIN1481 A2 D3x12 x2 40-DIN916 A2 M5x6 HEX2,5	40-DIN1481 A2 D5x12 x2 42-DIN7504M A2 4,2x50 TX20



Сечение		Артикул	I_x см ⁴	W_x см ³	S см ²
		Наименование	I_y см ⁴	W_y см ³	P мм
		<p>12-3220 Импост 84 мм усиленный</p>	117,99	18,27	8,136
			21,30	5,07	553

Профиль	Сухари		Химия	Комплектующие			
	Чаша I	Чаша II		Сбивка угла на прессе		Сборка угла на штифтах	
			Чаша I	Чаша II	Чаша I	Чаша II	
Соединение L							
12-3220	20-0200/0059	20-0200/0266		31-0010 x2		40-DIN1481 A2 D5x12 x2 31-0010 x2	40-DIN1481 A2 D5x12 x2
Соединение T							
12-3220	20-1051/0207	20-1261/0207				40-DIN1481 A2 D3x12 x2 40-DIN916 A2 M5x6 HEX2,5	40-DIN1481 A2 D5x12 x2 42-DIN7504M A2 4,2x50 TX20



Сечение	Артикул Наименование	I_x см ⁴	W_x см ³	S см ²
		I_y см ⁴	W_y см ³	P мм
	<p>12-3221 Импост 84 мм усиленный</p>	$\frac{145,85}{21,43}$	$\frac{22,07}{5,10}$	$\frac{2,519}{560}$

Профиль	Сухари		Химия	Комплектующие			
	Чаша I	Чаша II		Сбивка угла на прессе		Сборка угла на штифтах	
				Чаша I	Чаша II	Чаша I	Чаша II
Соединение L							
12-3221	20-0200/0059	20-0200/0266		31-0010	x2	40-DIN1481 A2 D5x12 x2 31-0010 x2	40-DIN1481 A2 D5x12 x2
Соединение T							
12-3221	20-1051/0207	20-1261/0207				40-DIN1481 A2 D3x12 x2 40-DIN916 A2 M5x6 HEX2,5	40-DIN1481 A2 D5x12 x2 42-DIN7504M A2 4,2x50 TX20



Сечение	Артикул Наименование	I_x см ⁴	W_x см ³	S см ²
		I_y см ⁴	W_y см ³	P мм
	<p>12-3230 Импост 70 мм в створку-Z</p>	<p>46,37 8,94</p>	<p>8,36 2,55</p>	<p>5,012 428</p>

Профиль	Сухари		Химия	Комплекующие			
	Чаша I	Чаша II		Сбивка угла на прессе		Сборка угла на штифтах	
				Чаша I	Чаша II	Чаша I	Чаша II
Соединение T							
12-3230	20-1051/0127	20-1261/0127				40-DIN1481 A2 x2 D3x8 40-DIN916 A2 M5x6 HEX2,5	40-DIN1481 A2 x2 D5x8 42-DIN7504M A2 4,2x50 TX20



Сечение	Артикул Наименование	I_x см ⁴	W_x см ³	S см ²
		I_y см ⁴	W_y см ³	P мм
	<p>12-3260 Импост 100 мм створки скрытой</p>	$41,72$ $23,87$	$9,43$ $4,20$	$5,649$ 489

Профиль	Сухари		Химия	Комплектующие			
	Чаша I	Чаша II		Сбивка угла на прессе		Сборка угла на штифтах	
				Чаша I	Чаша II	Чаша I	Чаша II
Соединение L							
12-3260	20-0200/0059	20-0200/0266		31-0010 x2		40-DIN1481 A2 D5x12 x2 31-0010 x2	40-DIN1481 A2 D5x12 x2
Соединение T							
12-3260	20-1051/0207	20-1261/0207				40-DIN1481 A2 D3x12 x2 40-DIN916 A2 M5x6 HEX2,5	40-DIN1481 A2 D5x12 x2 42-DIN7504M A2 4,2x50 TX20



Сечение			Артикул	I_x см ⁴	W_x см ³	S см ²	
			Наименование	I_y см ⁴	W_y см ³	P мм	
			12-3310 Створка-Z 73 мм	47,13 9,08	10,38 2,44	4,955 442	
			12-3320 Створка-Z 98 мм	67,11 33,59	15,50 6,79	7,066 543	
Профиль	Сухари		Химия	Комплекующие			
	Чаша I	Чаша II		Сбивка угла на прессе		Сборка угла на штифтах	
				Чаша I	Чаша II	Чаша I	Чаша II
Соединение L							
12-3310	20-0130/0059	20-0200/0315		31-0010	31-0010	40-DIN1481 A2 D5x12 x2 31-0010	40-DIN1481 A2 D5x12 x2 31-0010
12-3320	20-0370/0059	20-0440/0314		31-0010	31-0010	40-DIN1481 A2 D5x12 x2 31-0010	40-DIN1481 A2 D5x12 x2 31-0010



Сечение		Артикул Наименование	I_x см ⁴ I_y см ⁴	W_x см ³ W_y см ³	S см ² P мм
		<p>12-3332 Створка-Т 100 мм</p>			<p>0 0</p>

Профиль	Сухари		Химия	Комплектующие					
	Чаша I	Чаша II		Сбивка угла на прессе		Сборка угла на штифтах			
Чаша I			Чаша II	Чаша I	Чаша II	Чаша I	Чаша II		
Соединение L									
12-3332	20-0440/0279	20-0370/0100		31-0010	x2	40-DIN1481 A2 D5x12 31-0010	x2 x2	40-DIN1481 A2 D5x12	x2



Сечение		Артикул Наименование	I_x см ⁴ I_y см ⁴	W_x см ³ W_y см ³	S см ² P мм
		12-3341 Створка-Т 94 мм	48,91 34,16	11,29 6,99	6,852 502
		12-3360 Створка-Z 65 мм скрытая			0 0

Профиль	Сухари		Химия	Комплекующие			
	Чаша I	Чаша II		Сбивка угла на прессе		Сборка угла на штифтах	
				Чаша I	Чаша II	Чаша I	Чаша II
Соединение L							
12-3341	20-0440/0061	20-0440/0211		31-0010		40-DIN1481 A2 D5x12 x2 31-0010	40-DIN1481 A2 x2 D5x12
12-3360	20-0060/0059	20-0130/0311 20-0130/0074*			31-0010	40-DIN1481 A2 D3x8 x2	40-DIN1481 A2 x2 D5x12 31-0010

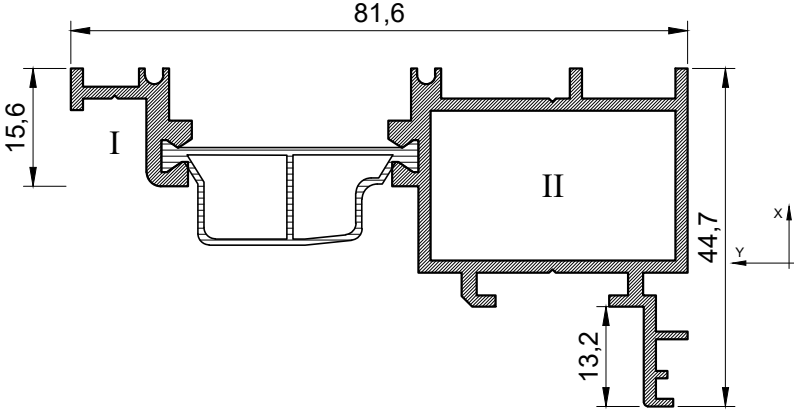

Сечение	Артикул Наименование	I_x см ⁴ I_y см ⁴	W_x см ³ W_y см ³	S см ² P мм
	<p>12-3371 Адаптер створки вентиляционной</p>			<p>0 0</p>



Сечение	Артикул Наименование	I_x см ⁴ I_y см ⁴	W_x см ³ W_y см ³	S см ² P мм
	<p>12-3370 Створка вентиляционная</p>			<p>0 0</p>



Сечение	Артикул Наименование	I_x см ⁴ I_y см ⁴	W_x см ³ W_y см ³	S см ² P мм
	<p>12-3410 Штульп 69 мм</p>	<p>$\frac{41,75}{11,59}$</p>	<p>$\frac{8,41}{2,86}$</p>	<p>$\frac{5,403}{444}$</p>
	<p>12-3421 Штульп 46 мм дверной</p>			<p>$\frac{0}{0}$</p>
	<p>12-3431 Профиль оборачивающий створки-Т</p>			<p>$\frac{0}{0}$</p>

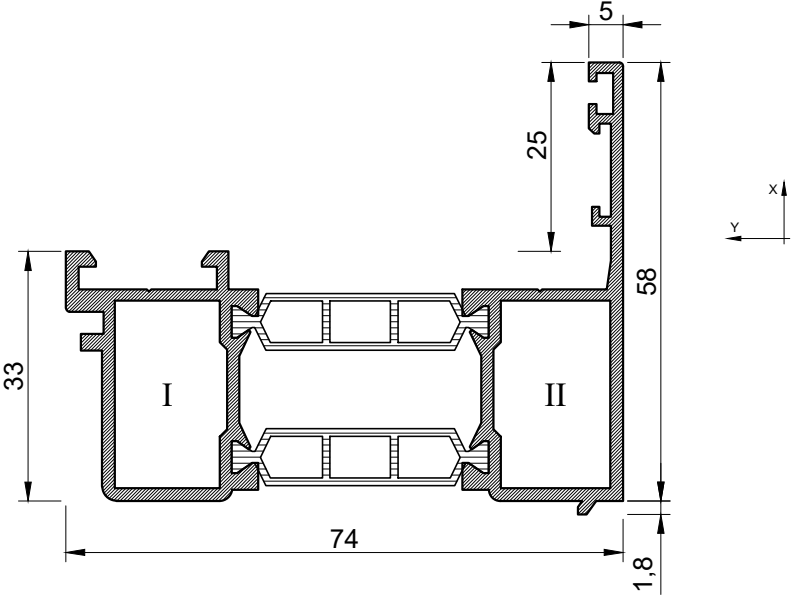

Сечение	Артикул Наименование	I_x см ⁴ I_y см ⁴	W_x см ³ W_y см ³	S см ² P мм
	<p>12-3440 Профиль оборачивающий</p>			<p>0 0</p>

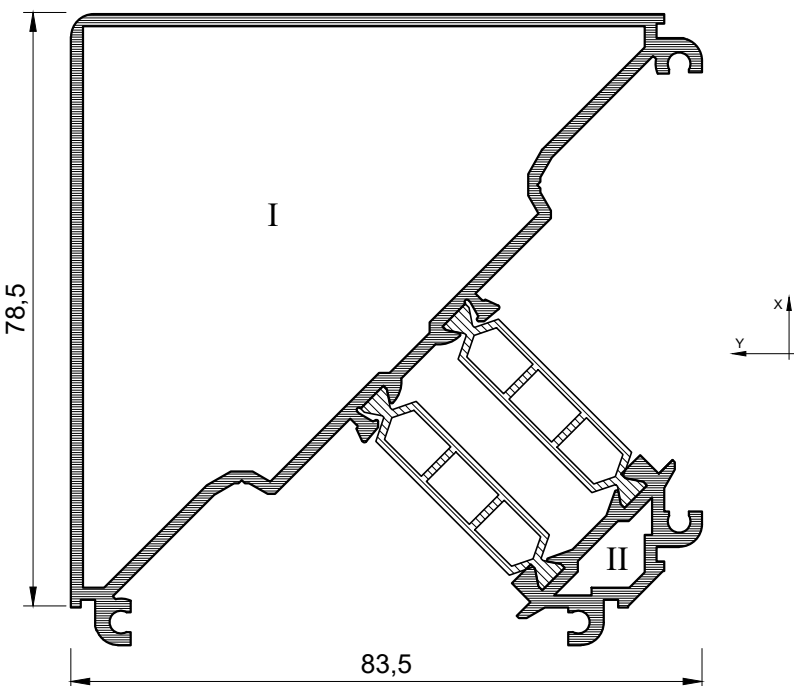

Сечение	Артикул Наименование	I_x см ⁴ I_y см ⁴	W_x см ³ W_y см ³	S см ² P мм
	<p>12-3511 Угол 90 градусов</p>			<p>0 0</p>

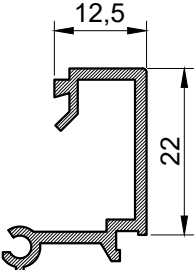
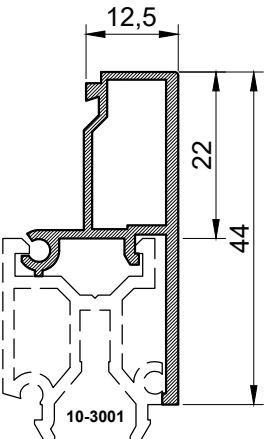
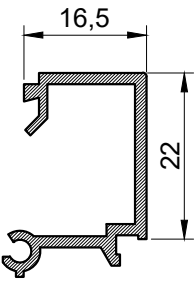
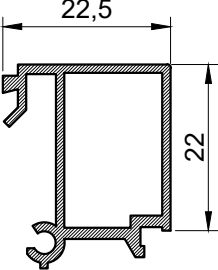
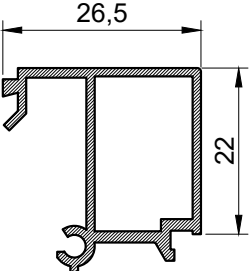

Сечение	Артикул Наименование	I_x см ⁴ I_y см ⁴	W_x см ³ W_y см ³	S см ² P мм
	<p>10-3120 Штапик 12,5 мм x 22 мм</p>			<p>0,96 134</p>
	<p>10-3121 Штапик 12,5 мм x 22 мм с крылом</p>			<p>0 0</p>
	<p>10-3160 Штапик 16,5 мм x 22 мм</p>			<p>1,018 142</p>
	<p>10-3220 Штапик 22,5 мм x 22 мм</p>			<p>1,15 130</p>
	<p>10-3260 Штапик 26,5 мм x 22 мм</p>			<p>1,2 133</p>

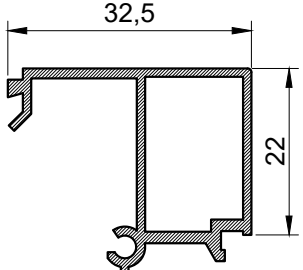
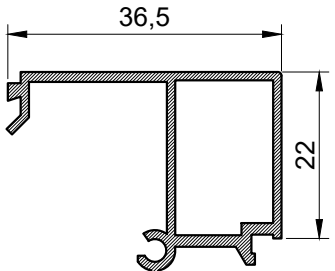
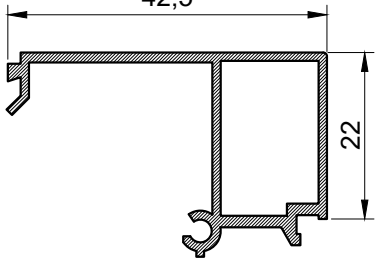
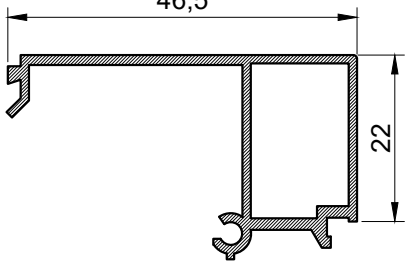

Сечение	Артикул Наименование	I_x см ⁴ I_y см ⁴	W_x см ³ W_y см ³	S см ² P мм
	<p>10-3320 Штапик 32,5 мм x 22 мм</p>			<p>1,21 150</p>
	<p>10-3360 Штапик 36,5 мм x 22 мм</p>			<p>1,33 153</p>
	<p>10-3420 Штапик 42,5 мм x 22 мм</p>			<p>1,347 236</p>
	<p>10-3460 Штапик 46,5 мм x 22 мм</p>			<p>0 0</p>

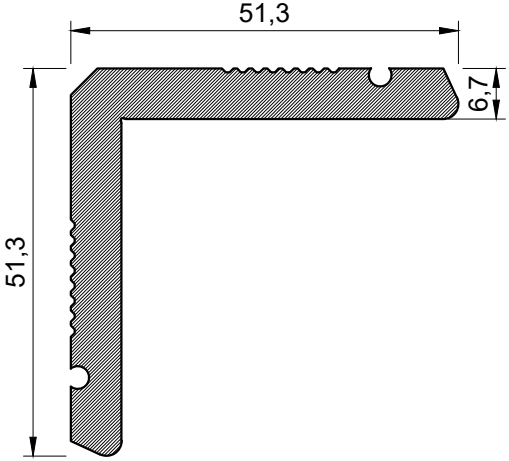
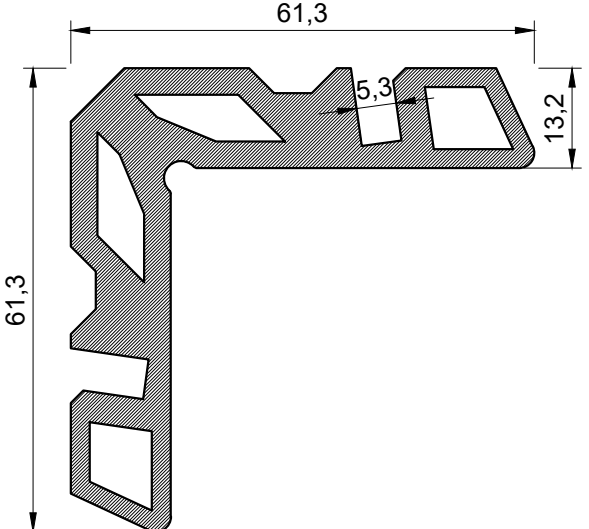
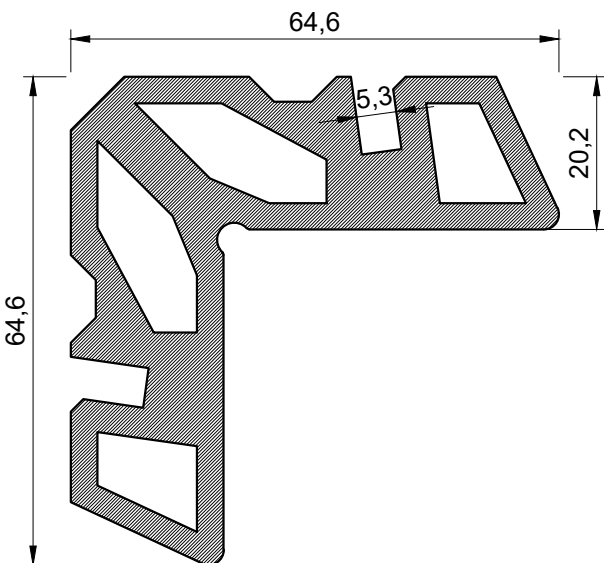

Сечение	Артикул Наименование	I_x см ⁴ I_y см ⁴	W_x см ³ W_y см ³	S см ² P мм
	<p>10-0060 Сухарь 6,7 мм</p>			<p>0 0</p>
	<p>10-0130 Сухарь 13,2 мм</p>			<p>89,9 271</p>
	<p>10-0200 Сухарь 20,2 мм</p>			<p>125 279</p>



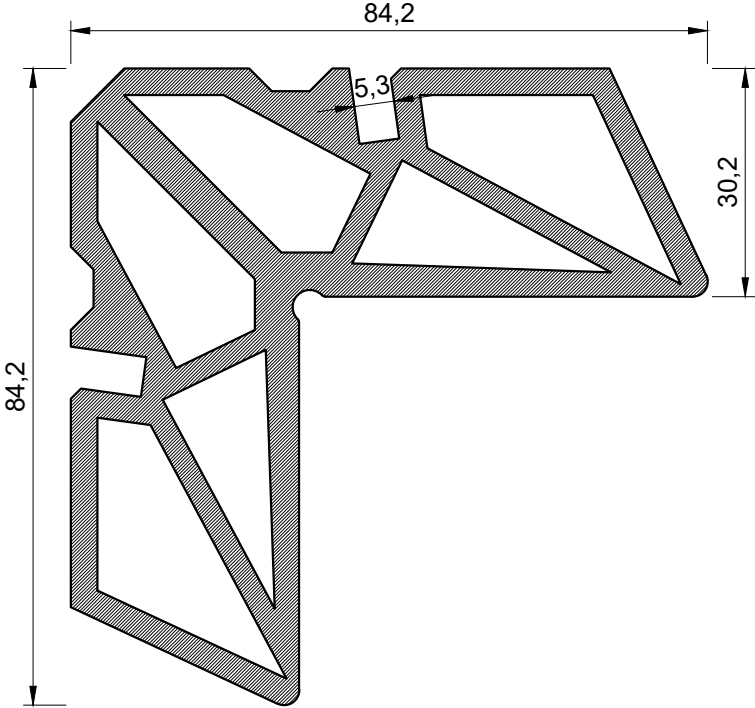
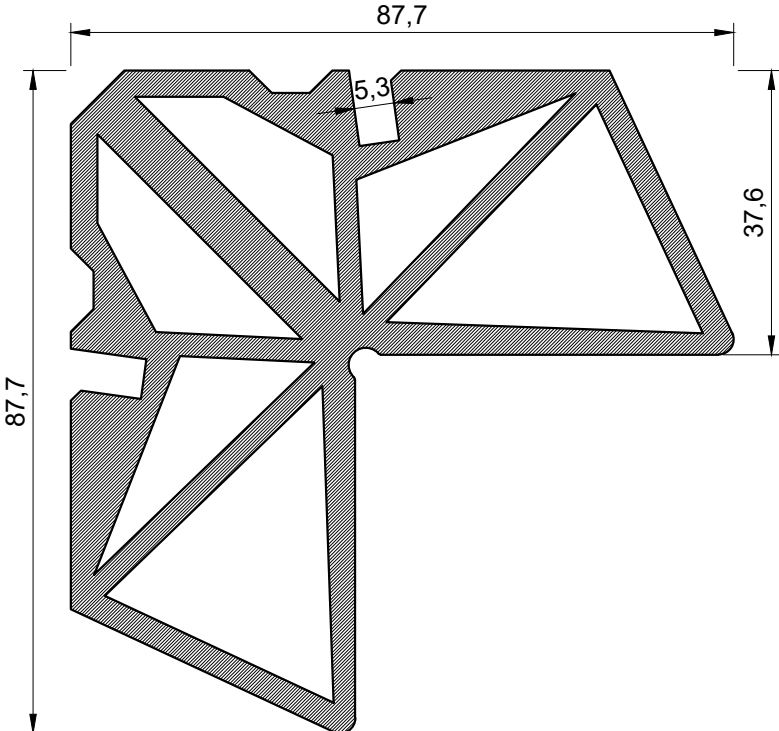

Сечение	Артикул Наименование	I_x см ⁴ I_y см ⁴	W_x см ³ W_y см ³	S см ² P мм
	<p>10-0300 Сухарь 30,2 мм</p>			<p>0 0</p>
	<p>10-0370 Сухарь 37,6 мм</p>			<p>208 358</p>

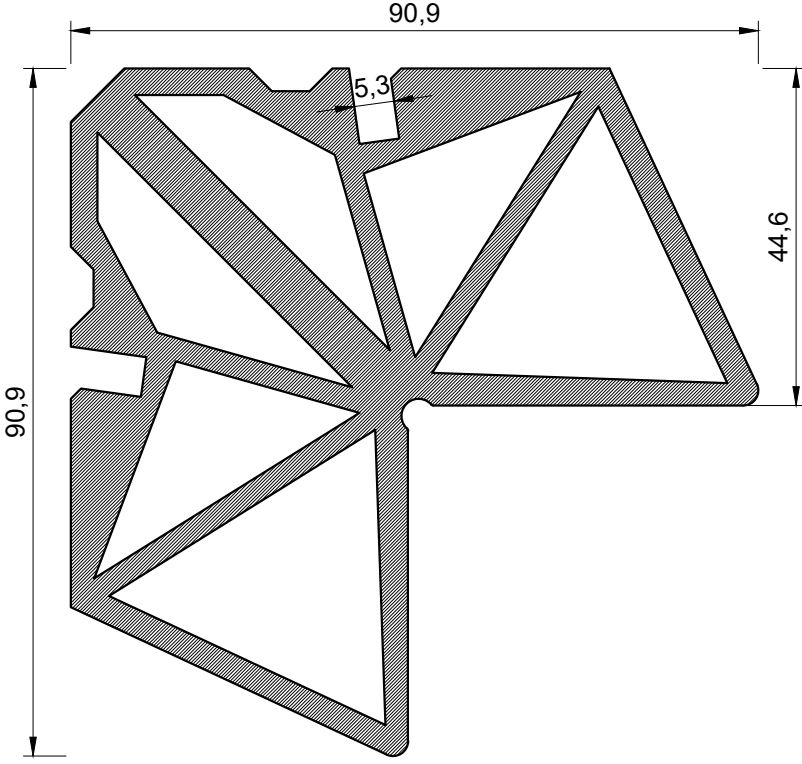

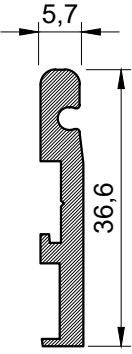
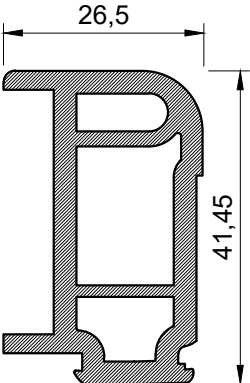
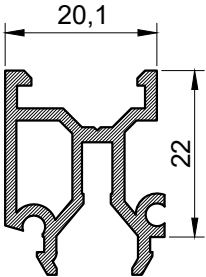
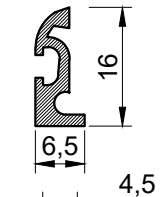

Сечение	Артикул Наименование	I_x см ⁴ I_y см ⁴	W_x см ³ W_y см ³	S см ² P мм
	<p>10-0440 Сухарь 44,6 мм</p>			<p>224 366</p>

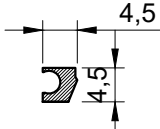
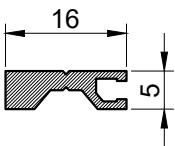

Сечение	Артикул Наименование	I_x см ⁴ I_y см ⁴	W_x см ³ W_y см ³	S см ² P мм
	<p>10-1051 Сухарь 5,7 мм крепления импоста</p>			$\frac{1,3987}{97}$
	<p>10-1261 Сухарь 26 мм крепления импоста</p>			$\frac{4,0032}{147}$
	<p>10-3001 Адаптер штапика с крылом</p>			$\frac{0}{0}$
	<p>10-4040 Штапик наружный створки скрытой</p>			$\frac{0}{0}$
	<p>10-5060 Профиль стыковочный</p>			$\frac{2,9}{35}$
	<p>10-5050 Профиль крепления мембраны</p>			$\frac{1,4}{22}$
	<p>10-5201 Профиль для уплотнителя порога</p>			$\frac{---}{---}$

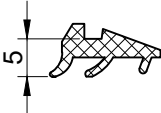
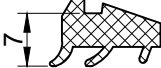
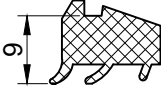
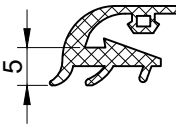
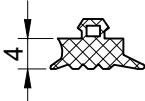
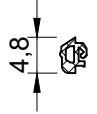
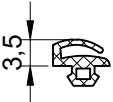
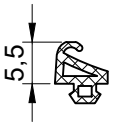
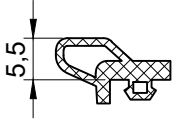

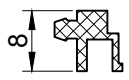
Сечение	Ед. Изм.	Н.У.	Артикул Наименование
	пог. м	250	50-1250 Уплотнитель под штапик 5 мм
	пог. м	200	50-1270 Уплотнитель под штапик 7 мм
	пог. м	200	50-1290 Уплотнитель под штапик 9 мм
	пог. м	300	50-1450 Уплотнитель под штапик 5 мм створки скрытой
	пог. м	300	50-2040 Уплотнитель под СП 4 мм
	пог. м	400	50-3001 Уплотнитель притвора 0,5 мм
	пог. м	400	50-3030 Уплотнитель притвора 3,5 мм
	пог. м	400	50-3051 Уплотнитель притвора 5,5 мм
	пог. м	100	50-3053
	пог. м	100	50-3054
	пог. м	320	50-3060 Уплотнитель притвора 6 мм



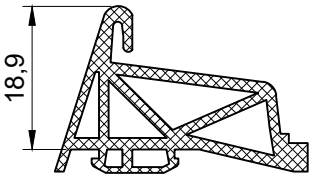
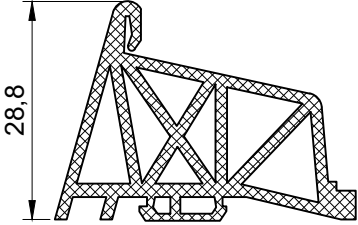
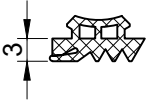
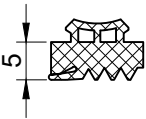
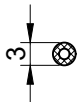
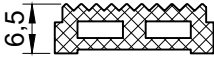
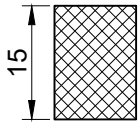
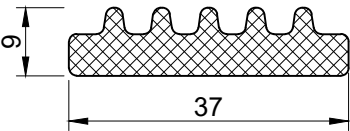



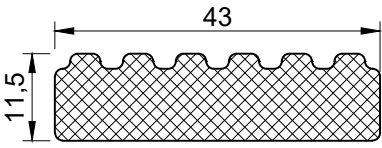
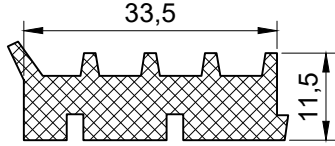
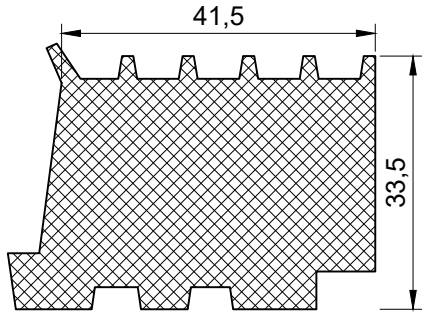
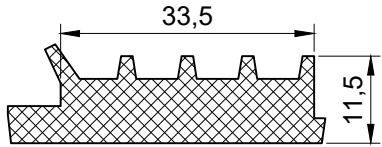
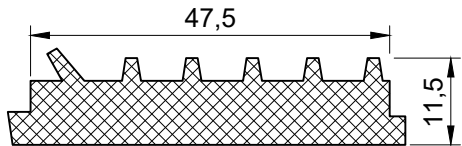
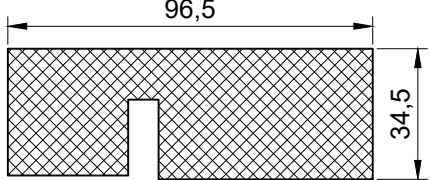
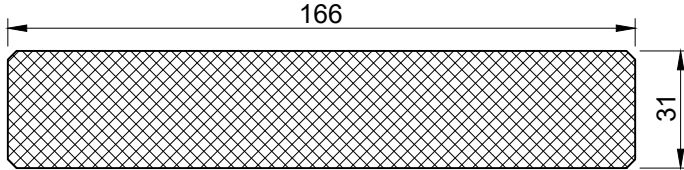



















Сечение	Ед. Изм.	Н.У.	Артикул Наименование
	пог. м	40	50-4230 Уплотнитель центральный WD74
	пог. м	40	50-4231 Уплотнитель центральный
	пог. м	210	50-5030 Уплотнитель внутренний 3 мм
	пог. м	160	50-5050 Уплотнитель внутренний 5 мм
	пог. м	500	50-7010 Уплотнитель круглый Д3 мм
	пог. м	200	51-2002 Заглушка порога
	пог. м	25	52-2001 ПСУЛ 15x5 мм
	пог. м	-	52-2003 Уплотнитель вспененный 37*9 мм











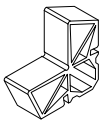

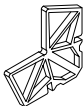

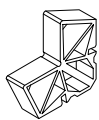

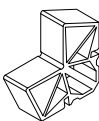

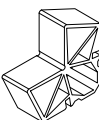





Сечение	Ед. Изм.	Н.У.	Артикул Наименование
	пог. м	-	52-2004 Уплотнитель вспененный 11,5x43 мм
	пог. м	-	52-5001 Уплотнитель фальца 11,5x33,5 мм
	пог. м	-	52-5002 Уплотнитель фальца 33,5x41,5 мм
	пог. м	-	52-5003 Уплотнитель фальца 11,5x33,5 мм
	пог. м	-	52-5004 Уплотнитель фальца 11,5x47,5 мм
	пог. м	-	52-5006 Уплотнитель 34,6x96,5 мм
	пог. м	-	52-5007 Уплотнитель 31x166 мм













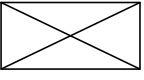

Сечение	Внешний вид	Ед. Изм.	Н.У.	Артикул Наименование
		шт.	20	20-0060/0059 Сухарь 6,7 мм х5,9 мм
		шт.	20	20-0130/0059 Сухарь 13,2 мм х5,9 мм
		шт.	20	20-0130/0074 Сухарь 13,2 мм х7,4 мм
		шт.	10	20-0130/0266 Сухарь 13,2 мм х26,6 мм
		шт.	10	20-0130/0311 Сухарь 13,2 мм х31,1 мм
		шт.	20	20-0200/0059 Сухарь 20,2 мм х5,9 мм
		шт.	10	20-0200/0266 Сухарь 20,2 мм х26,6 мм
		шт.	10	20-0200/0315 Сухарь 20,2 мм х31,5 мм
		шт.	20	20-0300/0059 Сухарь 30,2 мм х5,9 мм
		шт.	10	20-0300/0266 Сухарь 30,0 мм х26,6 мм
		шт.	20	20-0370/0059 Сухарь 37,6 мм х5,9 мм
		шт.	20	20-0370/0100 Сухарь 37,6 мм х10,0 мм

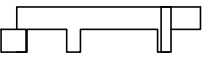
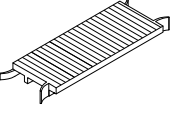

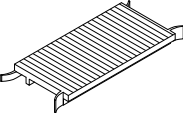
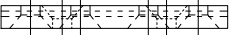
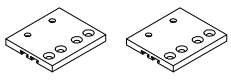
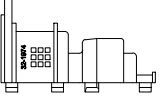
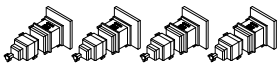
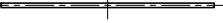
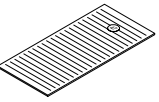

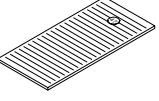
Сечение	Внешний вид	Ед. Изм.	Н.У.	Артикул Наименование
		шт.	10	20-0370/0296 Сухарь 37,6 мм х29,6 мм
		шт.	20	20-0440/0061 Сухарь 44,6 мм х6,1 мм
		шт.	10	20-0440/0211 Сухарь 44,6 мм х21,1 мм
		шт.	10	20-0440/0279 Сухарь 44,6 мм х27,9 мм
		шт.	10	20-0440/0314 Сухарь 44,6 мм х31,4 мм
		шт.	50	20-1051/0127 Сухарь 5,7 мм х12,7 мм
		шт.	50	20-1051/0207 Сухарь 5,7 мм х20,7 мм
		шт.	50	20-1051/0307 Сухарь 5,7 мм х30,7 мм
		шт.	1	20-1051/0817 Сухарь 5,7 мм х81,7 мм
		шт.	50	20-1261/0127 Сухарь 26,0 мм х12,7 мм
		шт.	50	20-1261/0207 Сухарь 26,0 мм х20,7 мм
		шт.	40	20-1261/0307 Сухарь 26,0 мм х30,7 мм

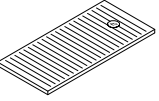
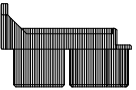
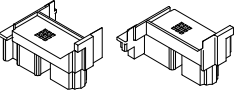



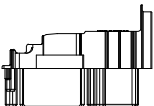
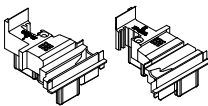
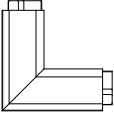
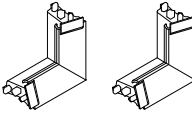
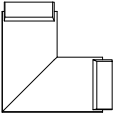
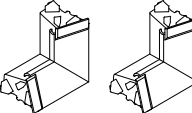

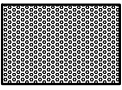













Сечение	Внешний вид	Ед. Изм.	Н.У.	Артикул Наименование
		шт.	50	31-0010 Уголок выравнивающий
		шт.	10	32-0004 Опора СП 22x46 мм
		шт.	10	32-0020 Крышка дренажная оконная
		шт.	10	32-1510 Заглушка Д10 мм
		шт.	1	32-1640 Опора СП 40 мм
		шт.	1	32-1650 Опора СП 50 мм
		пара.	1	32-1874 Комплект креплений порога WD74
		компл.	1	32-1974 Комплект заглушек створки вентиляционной
		шт.	100	32-6471 Пластина рихтовочная 47x1 мм
		шт.	100	32-6472 Пластина рихтовочная 47x2 мм
		шт.	100	32-6473 Пластина рихтовочная 47x3 мм
		компл.	1	33-1974 Комплект заглушек ступельных дверных WD74

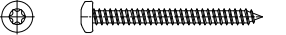

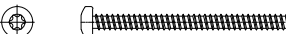

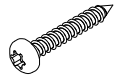
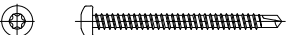
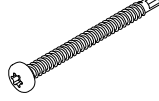
Сечение	Внешний вид	Ед. Изм.	Н.У.	Артикул Наименование
		компл.	1	33-2074 Комплект заглушек штульповых оконных WD74
		компл.	1	33-2174 Уголок уплотнения центрального WD74
		компл.	1	33-2175 Уголок уплотнения центрального WD74
		пог. м	6,5	65-1001 Профиль базы
		пог. м	1,2	65-1005 Trioterm 35x52 мм



Сечение	Внешний вид	Ед. Изм.	Н.У.	Артикул Наименование
		шт.	100	40-DIN916 A2 M5x6 HEX2,5 Винт установочный с кантом
		шт.		40-DIN1481 A2 D3x8 Штифт
		шт.		40-DIN1481 A2 D3x12 Штифт
		шт.		40-DIN1481 A2 D5x8 Штифт
		шт.		40-DIN1481 A2 D5x12 Штифт
		шт.		41-DIN7981C A2 3,9x50 TX15 Шуруп с полукруглой головкой
		шт.	200	41-DIN7981C A2 4,2x45 TX20 Шуруп с полукруглой головкой
		шт.	200	41-DIN7981C A2 4,2x60 TX20 Шуруп с полукруглой головкой
		шт.	500	41-DIN7981C A2 4,8x32 TX25 Шуруп с полукруглой головкой
		шт.		42-DIN7504M A2 4,2x50 TX20 Шуруп сверлоконечный с полукруглой головкой
		шт.	1000	43-DIN7982C A2 3,9x16 TX15 Шуруп с тайной головкой

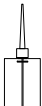
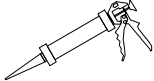

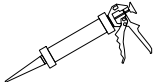
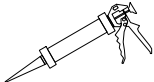
Сечение	Внешний вид	Ед. Изм.	Н.У.	Артикул Наименование
		шт.	1	80-2002 Клей двухкомпонентный Cosmofen DUO
		шт.	1	80-3002 Клей-герметик полиуретановый черный COSMO HD-100.412
		шт.	1	80-4001 Очиститель Cosmofen 60
		шт.	1	80-6002 Клей гибридный полимерный blaugelb Power Fix
		шт.	1	80-9001 Клей-герметик для ЭПДМ SikaBond TF Plus N



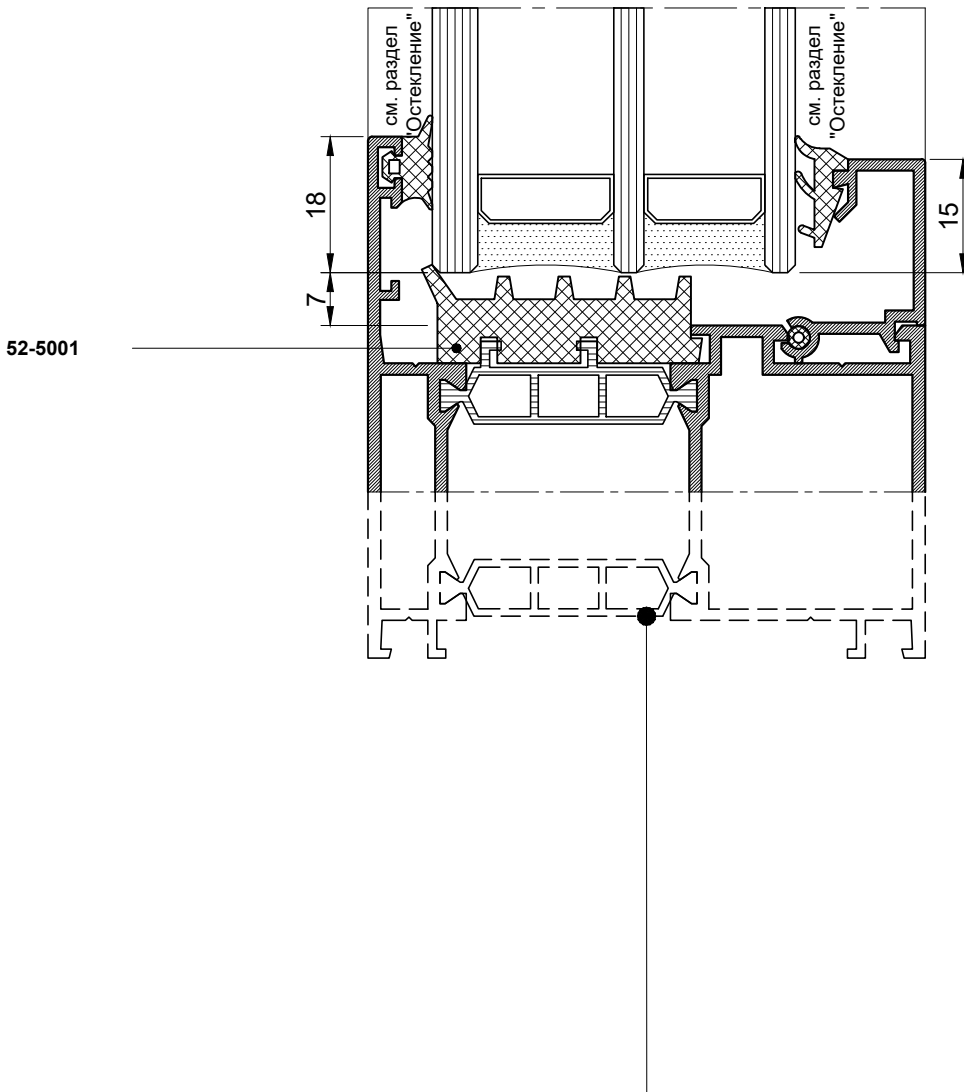
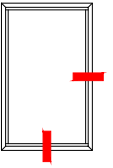

12-3110

12-3130

12-3152

12-3210

12-3220

12-3221

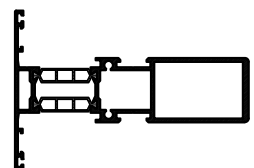
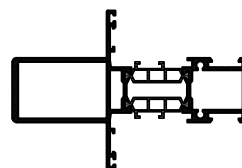
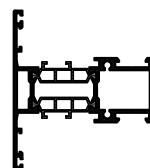
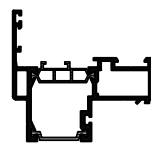
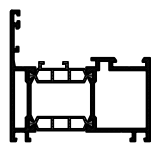
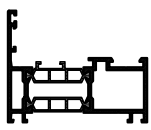

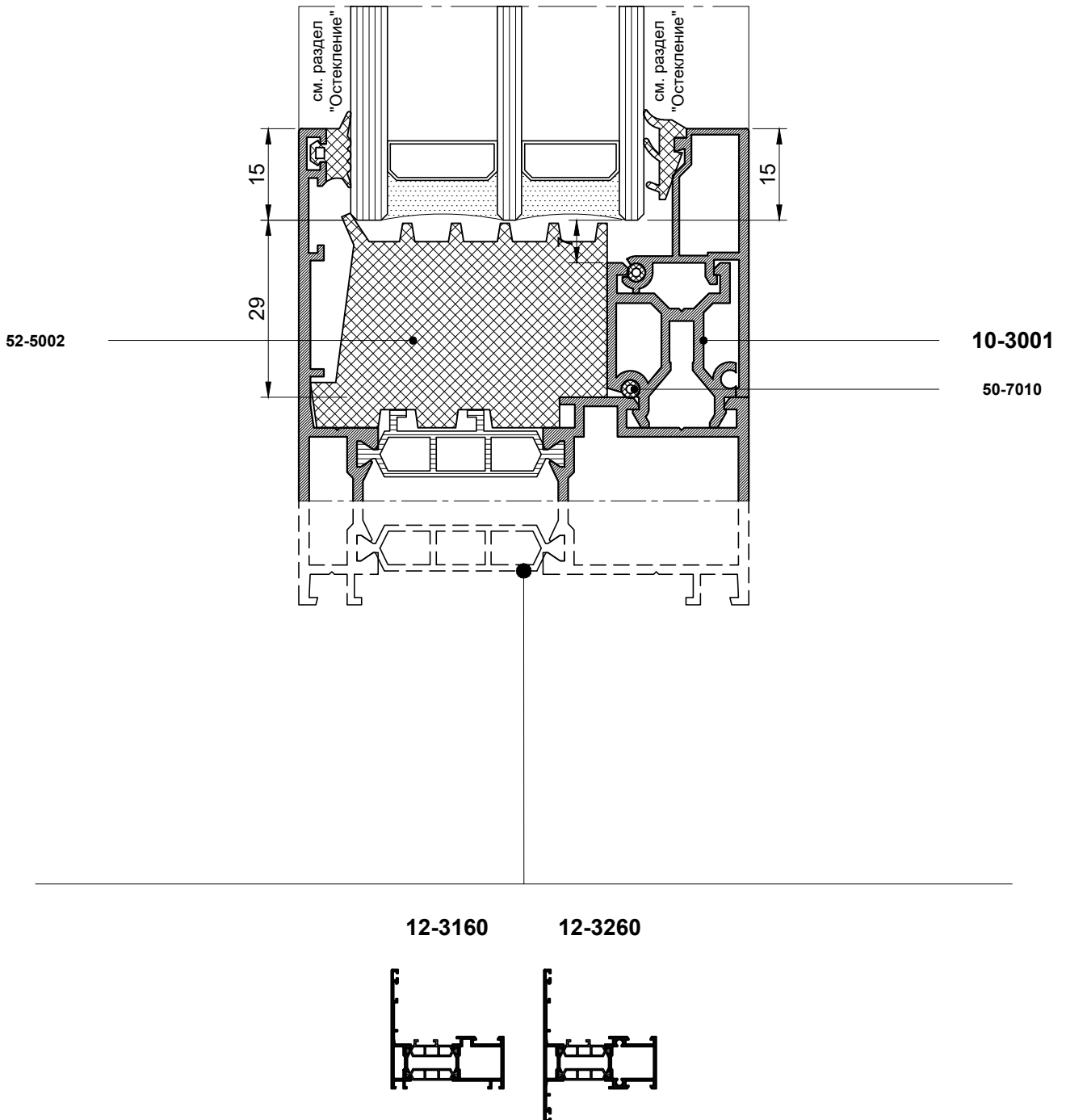
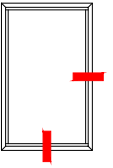

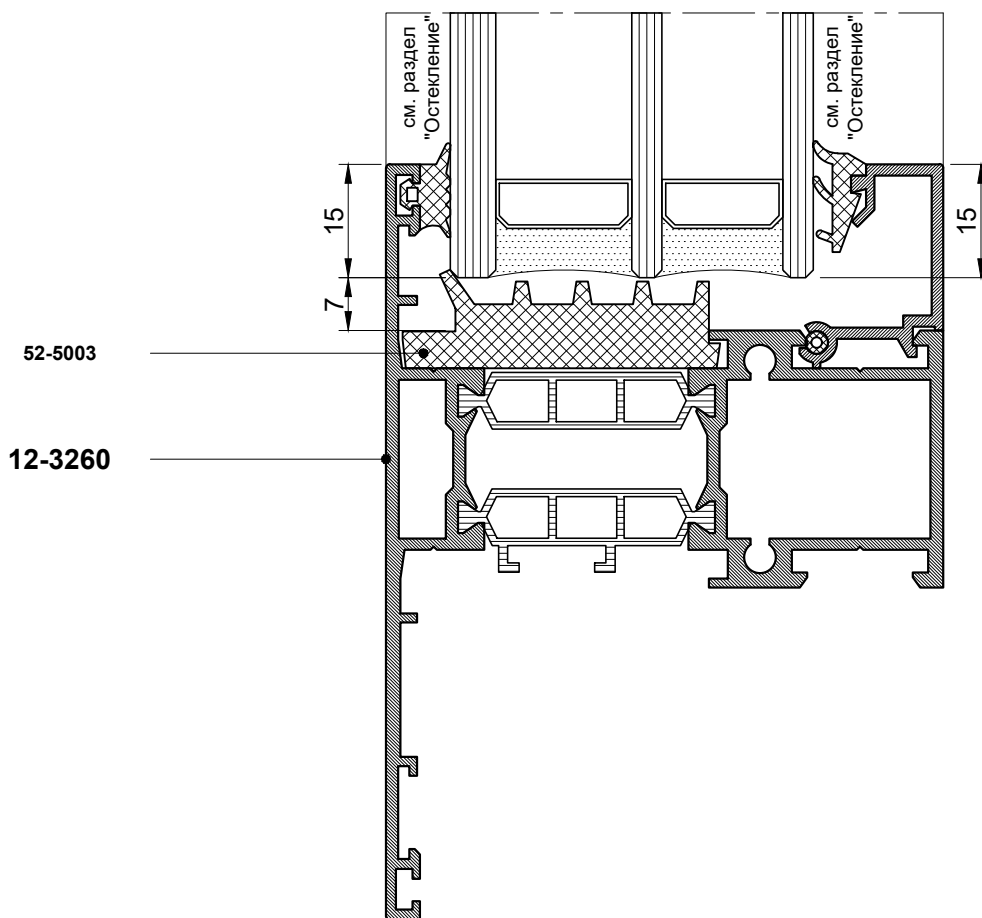
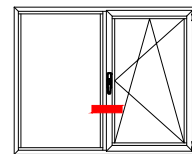

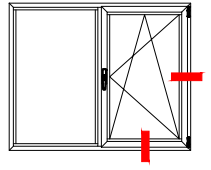

52-5004

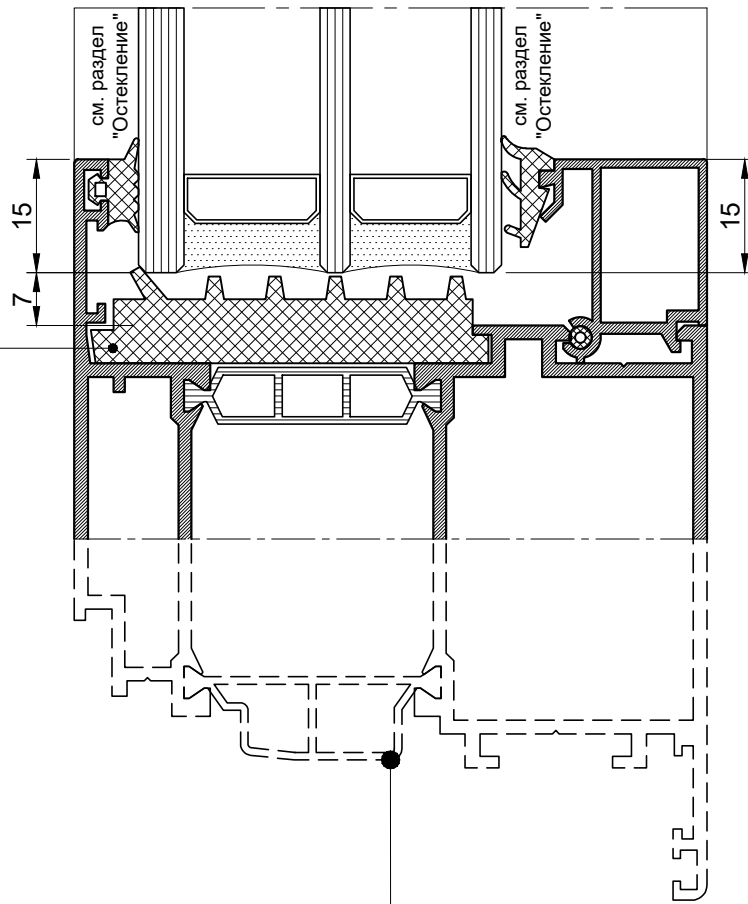

12-3310

12-3320

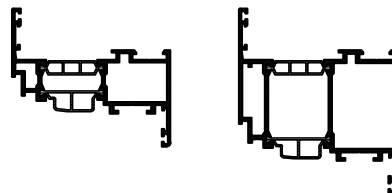

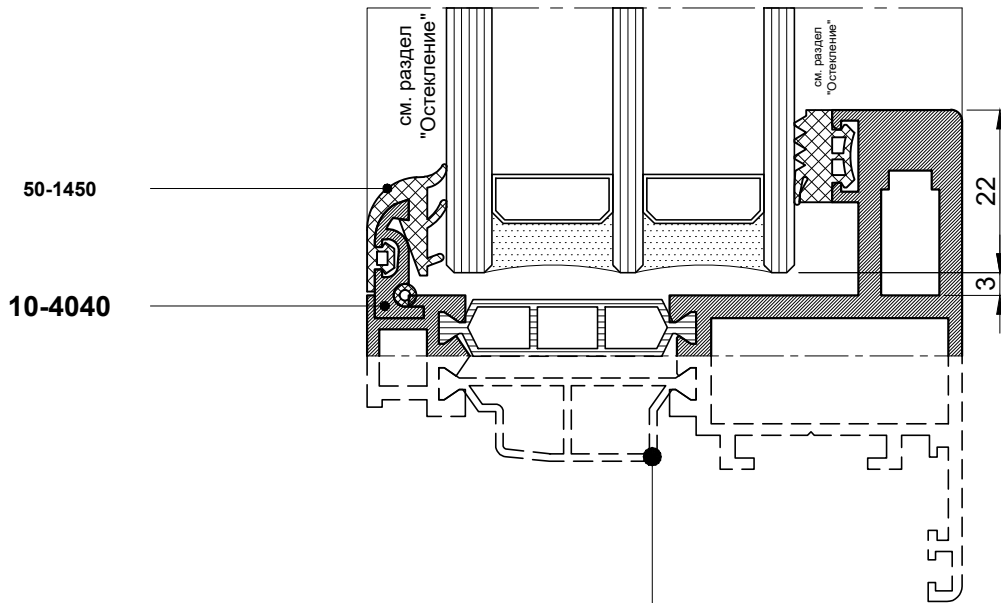
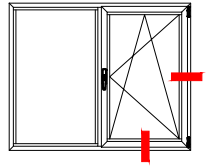

12-3360

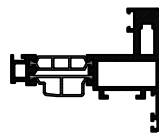

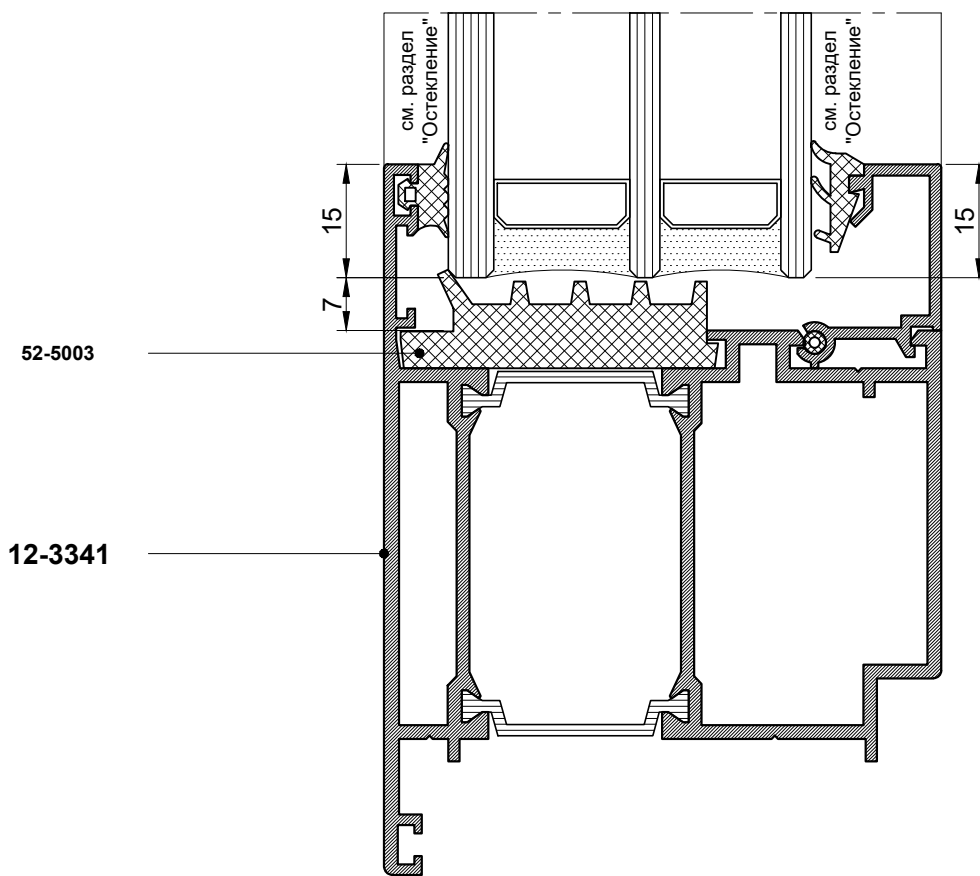
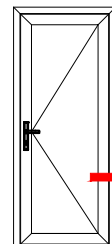

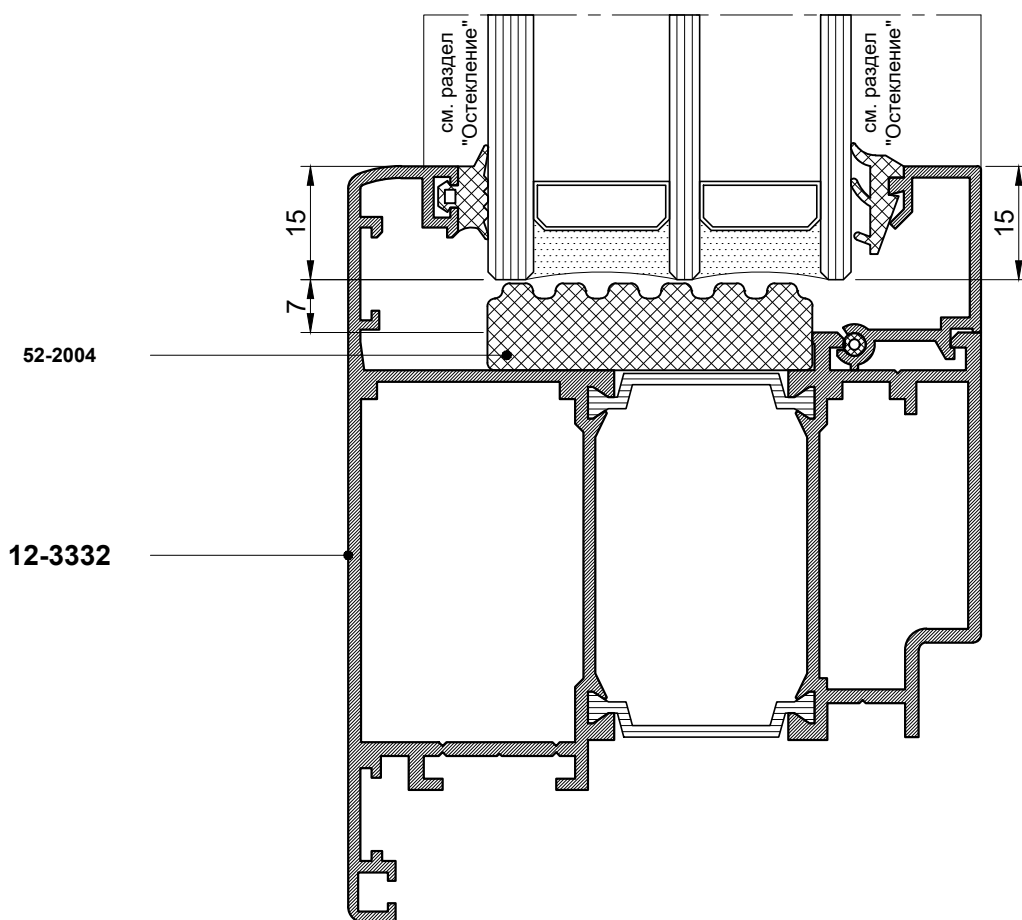
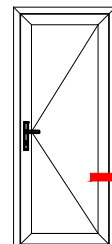

12-3310

12-3320

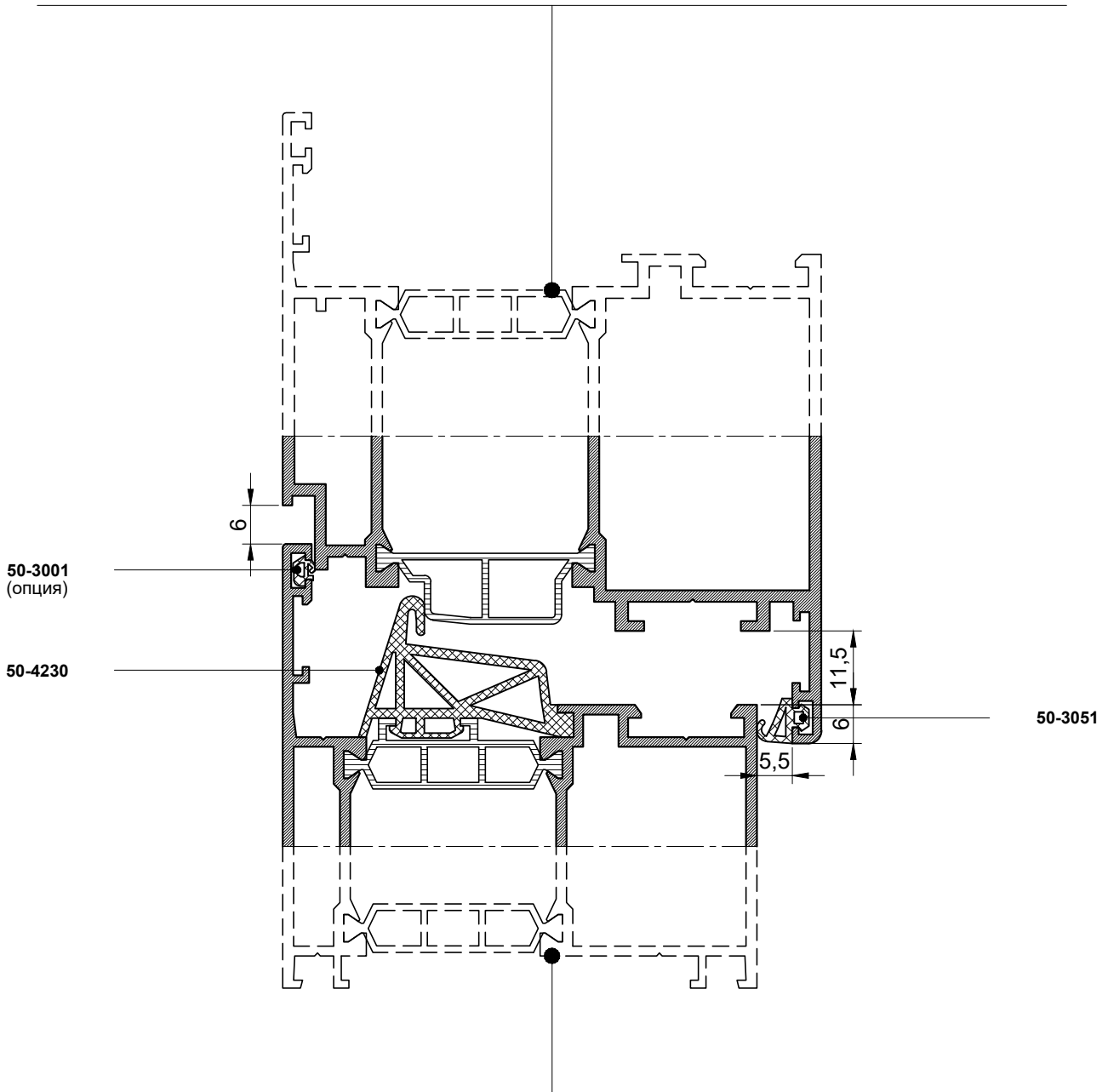
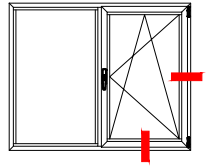
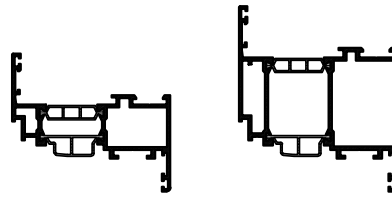

12-3110

12-3130

12-3152

12-3210

12-3220

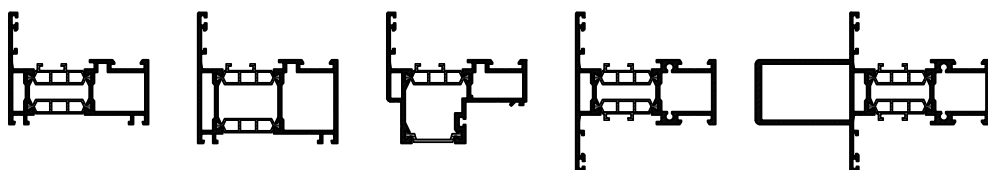

12-3360

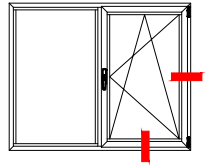
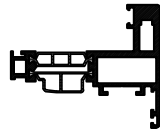

50-1450
10-4040
50-3001
(опция)

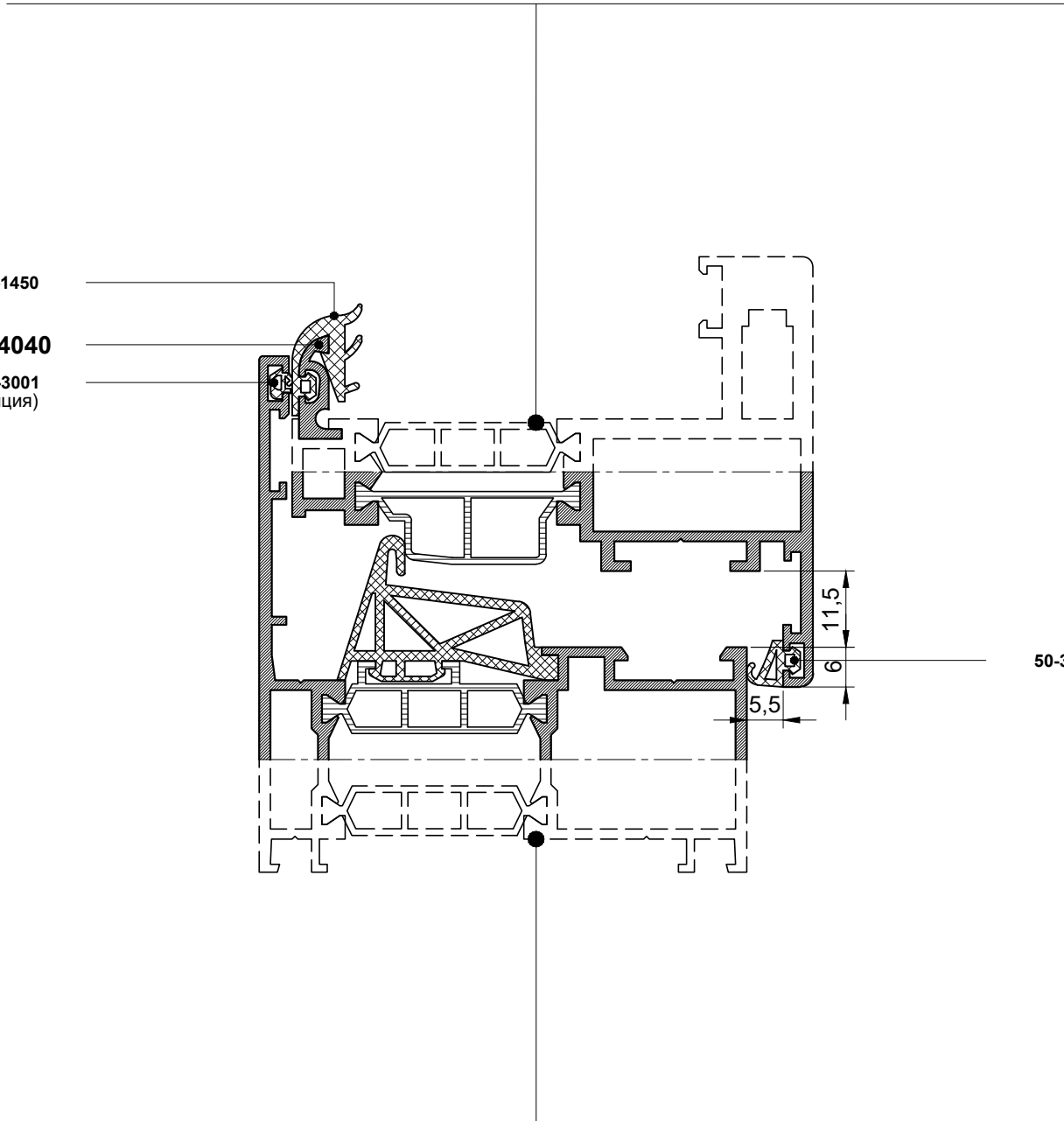

12-3160

12-3260

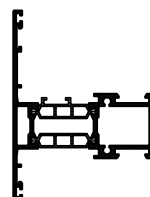
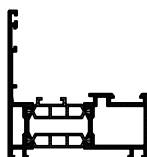

12-3310

12-3320

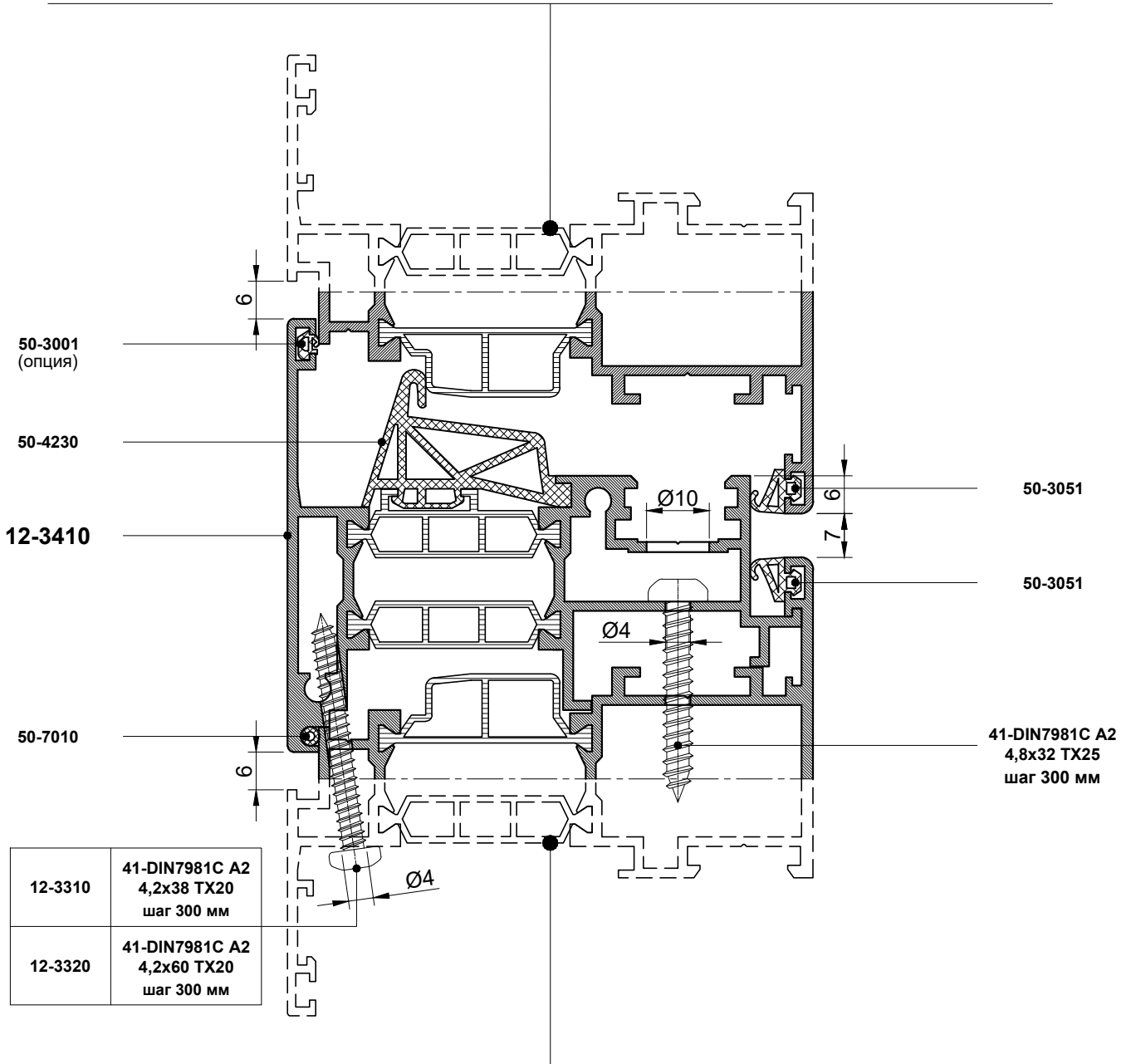
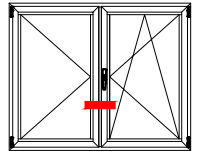
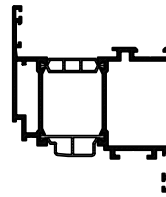
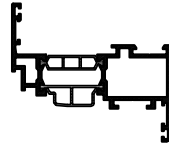

12-3310

12-3320

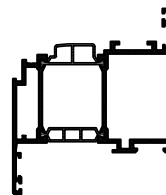
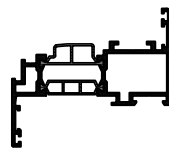

12-3110

12-3130

12-3152

12-3210

12-3220

12-3221

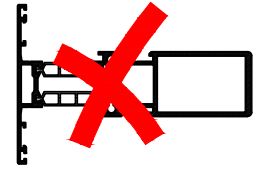
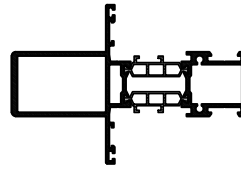
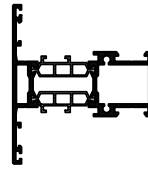
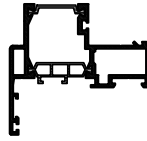
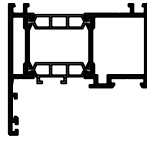
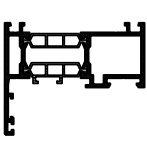

50-4231

50-3053

12,5

M 1:2

52-5007

50-3053

50-4231

12,5

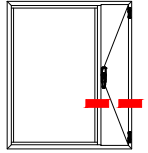
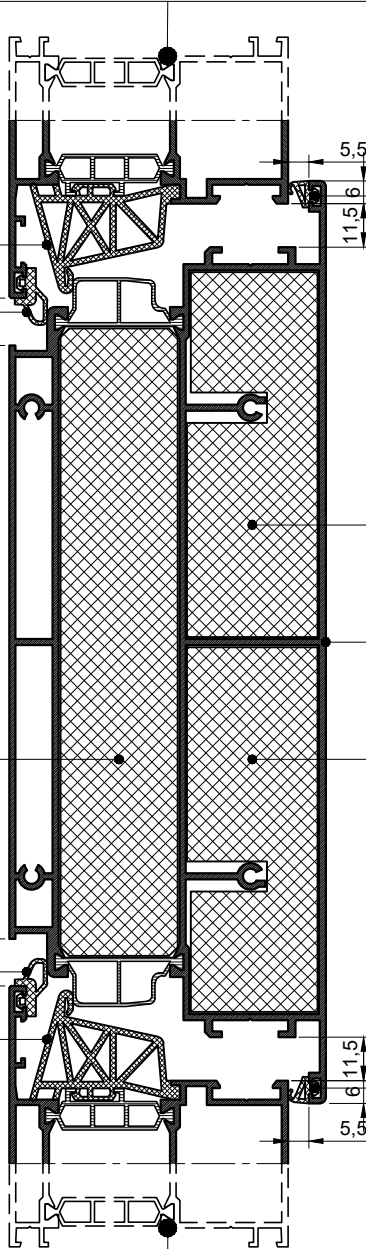

50-3051

52-5006

12-3370

52-5006

50-3051

5,5

11,5

6

11,5

5,5

12-3110

12-3130

12-3152

12-3210

12-3220

12-3221

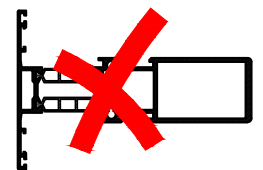
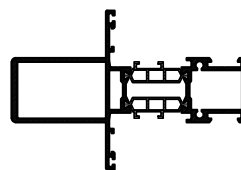
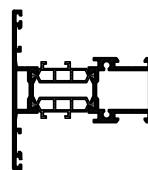
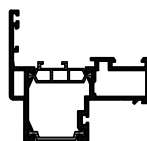
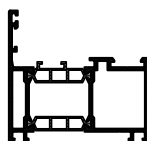
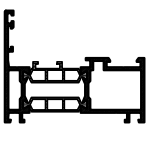

12-3110

12-3130

12-3152

12-3210

12-3220

12-3221

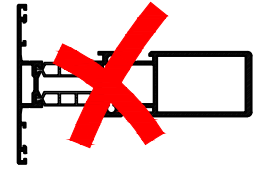
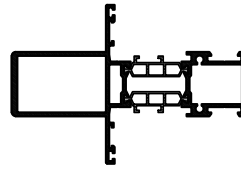
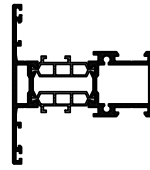
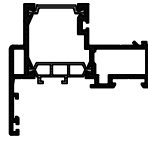
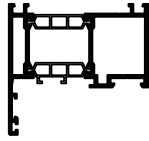
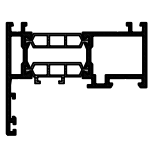

52-5001

52-2004

50-3053

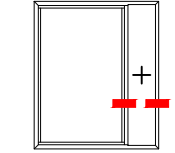
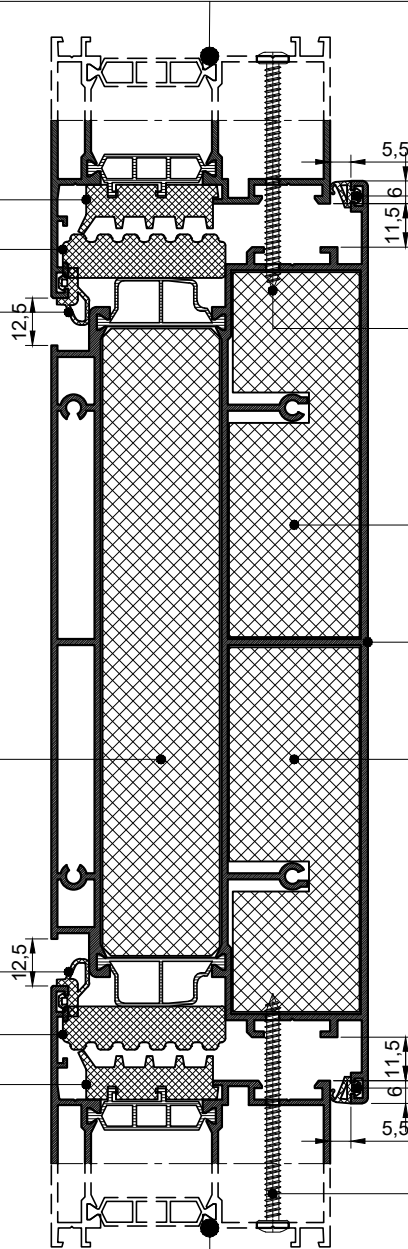

50-3051

41-DIN7981C A2
4,2x60 TX20
шаг 300 мм

52-5006

M 1:2

12-3370

52-5007

52-5006

50-3053

52-2004

52-5001

50-3051

41-DIN7981C A2
4,2x60 TX20
шаг 300 мм

12-3110

12-3130

12-3152

12-3210

12-3220

12-3221

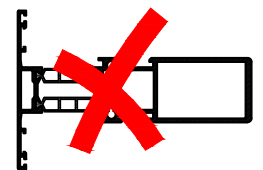
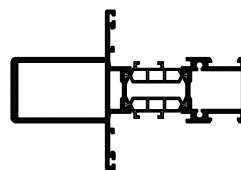
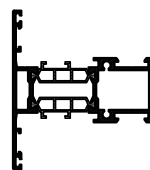
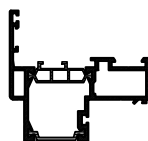
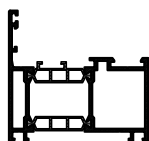
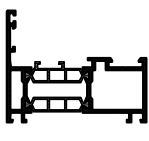

12-3370

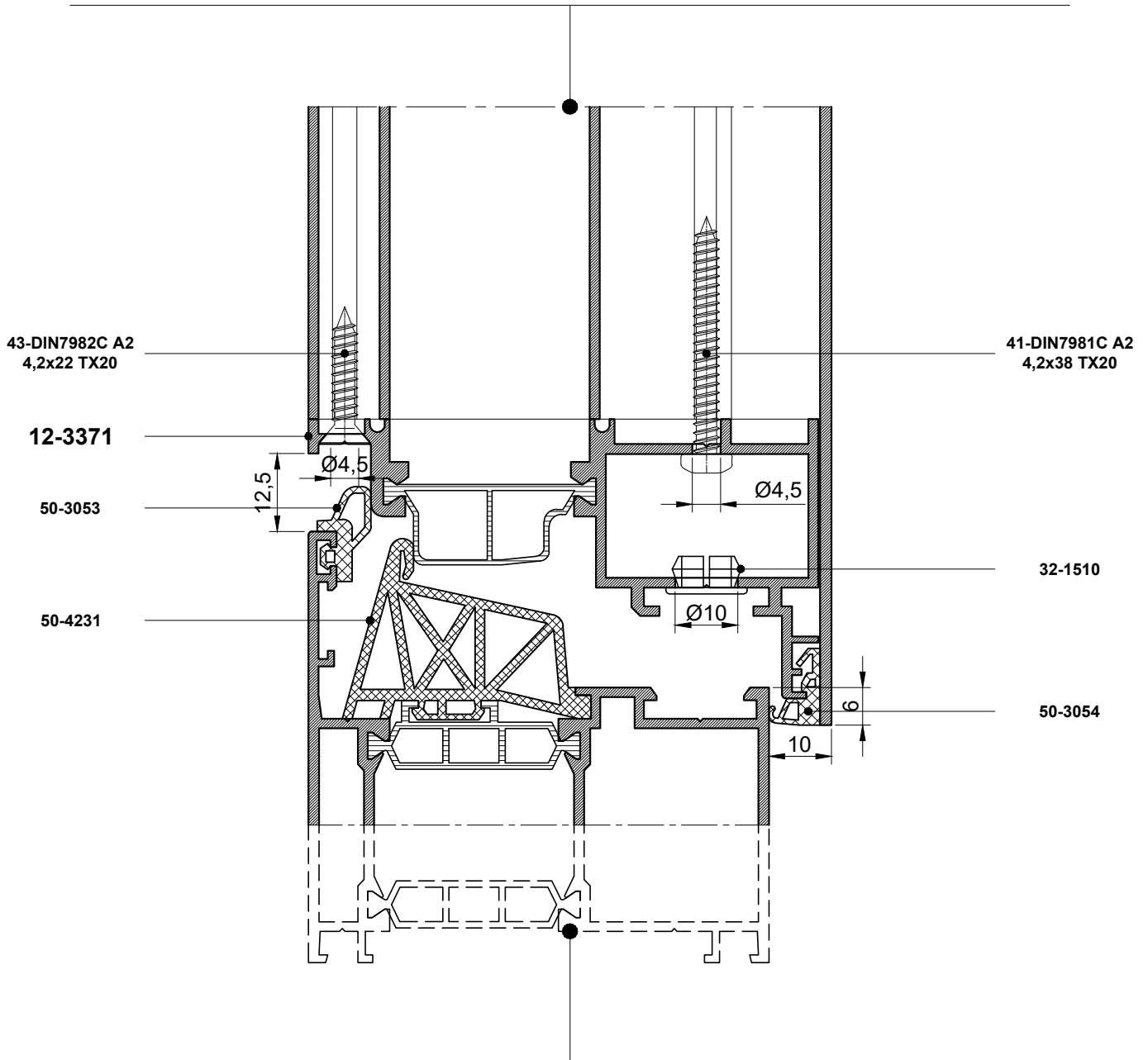
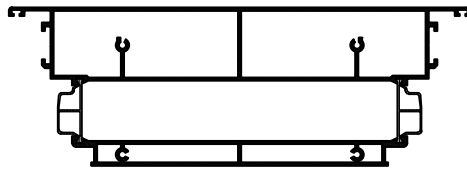
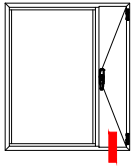

12-3110

12-3130

12-3152

12-3210

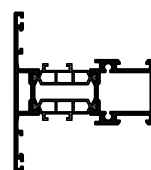
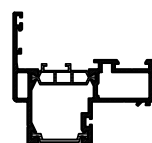
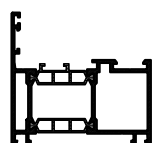
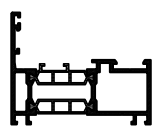

12-3370

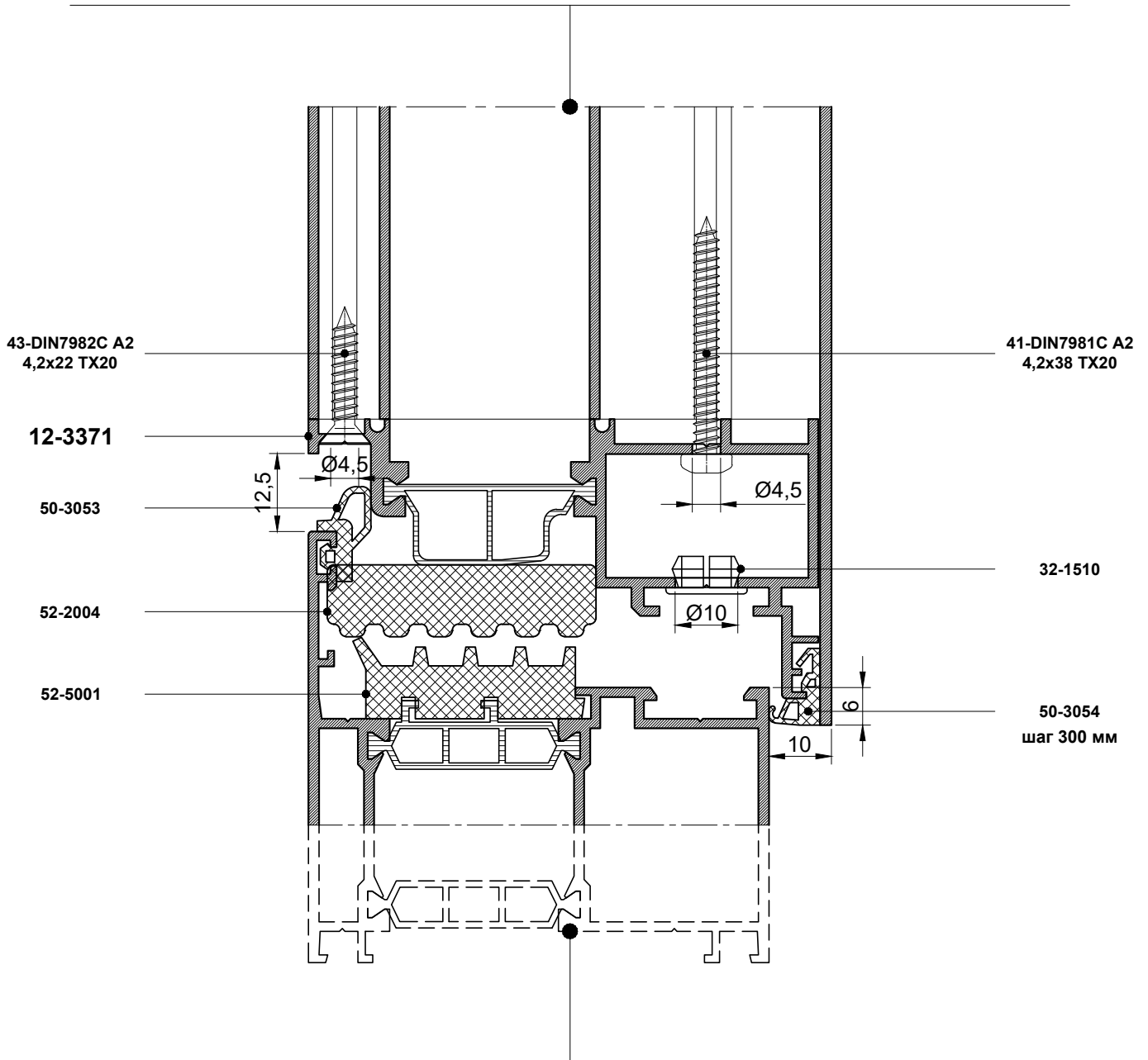
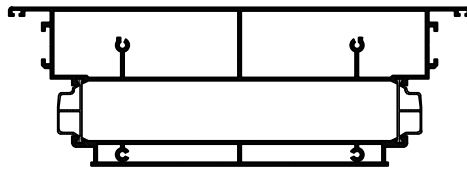
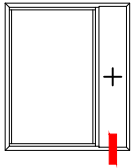

12-3110

12-3130

12-3152

12-3210

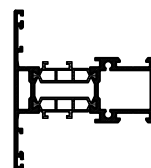
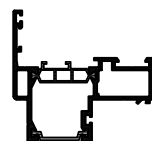
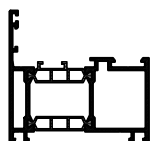
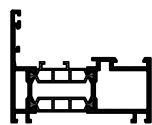

12-3110

12-3130

12-3122

12-3160

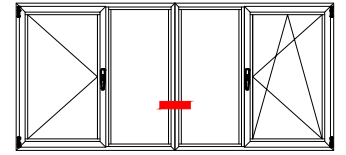
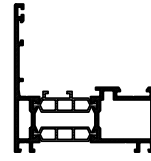
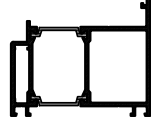
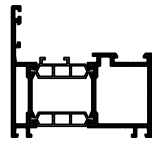
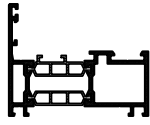

52-2001

10-5060
50-7010

10-5060
50-7010

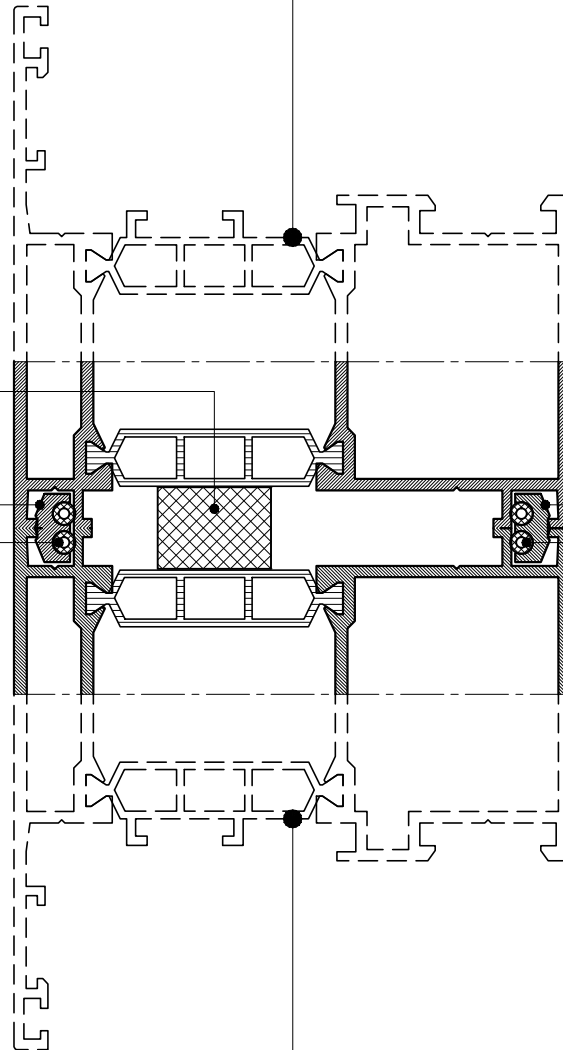

12-3110

12-3130

12-3122

12-3160

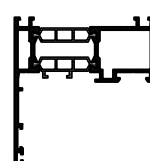
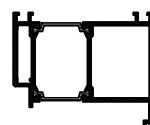
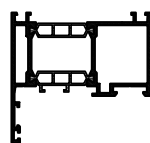
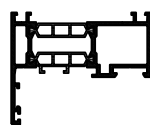

12-3110

12-3130

12-3122

12-3160

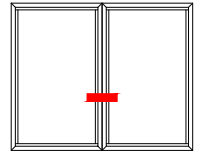
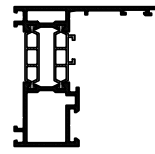
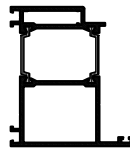
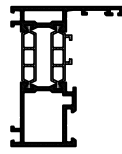
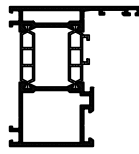

12-3511

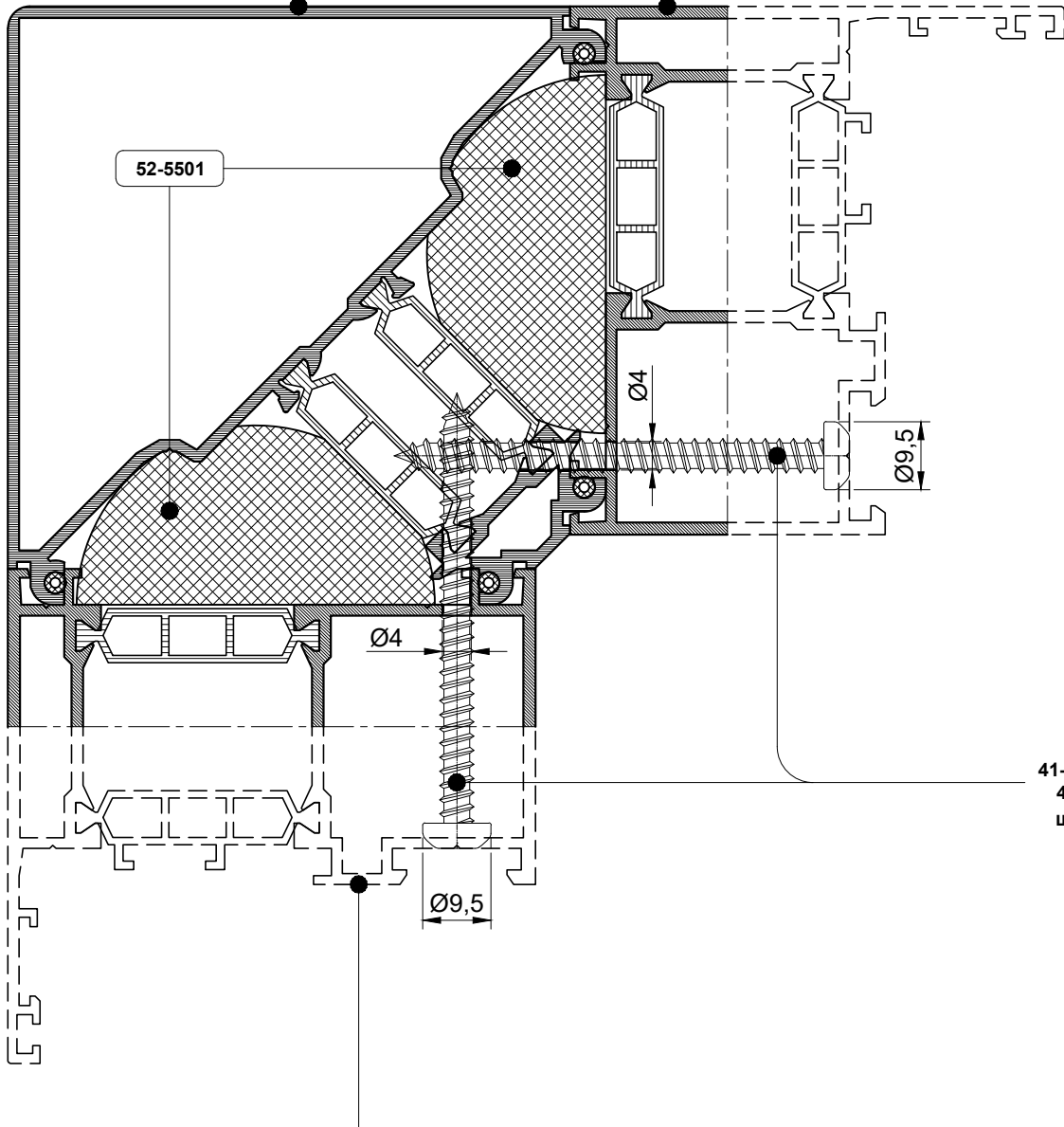

41-DIN7981C A2
4,8x60 TX25
шаг 300 мм

12-3110

12-3130

12-3122

12-3160

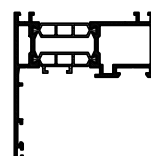
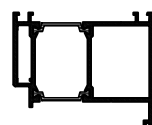
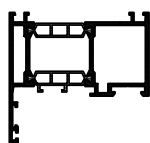
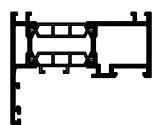

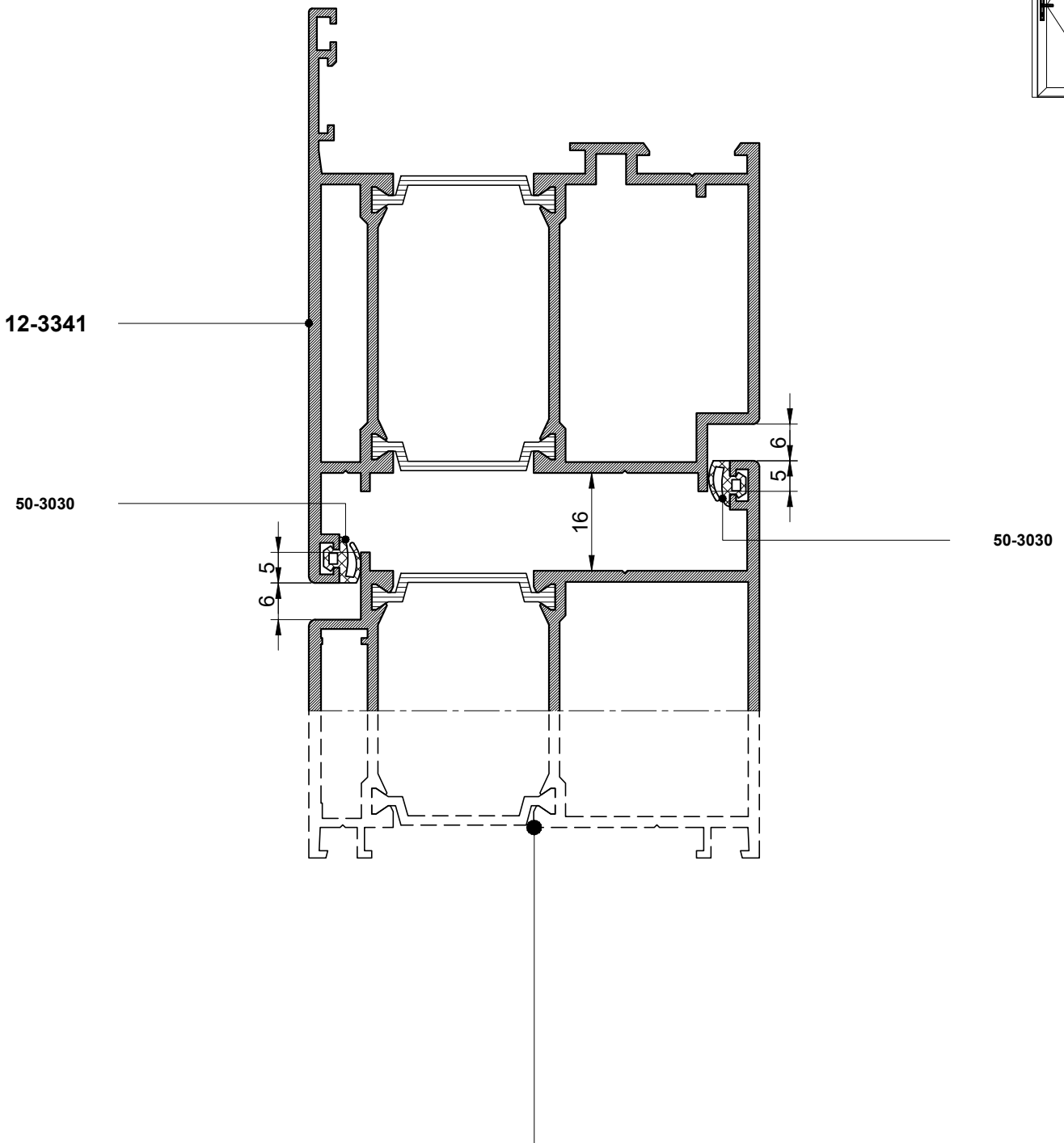
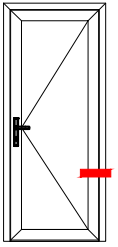

12-3122

12-3141

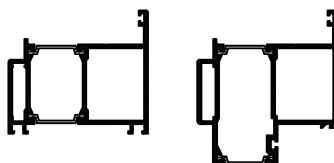

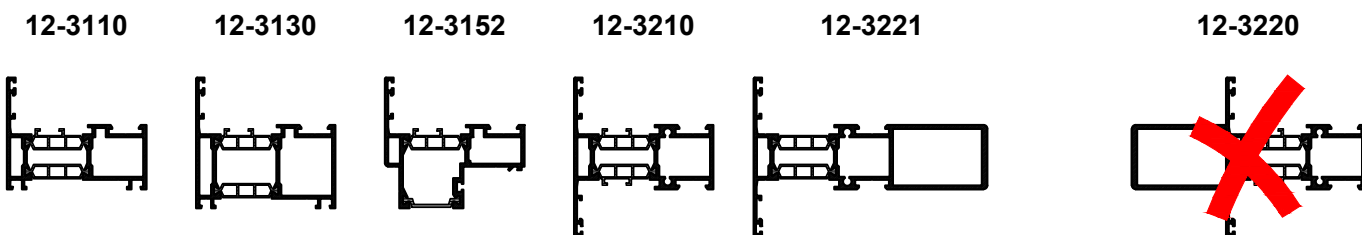
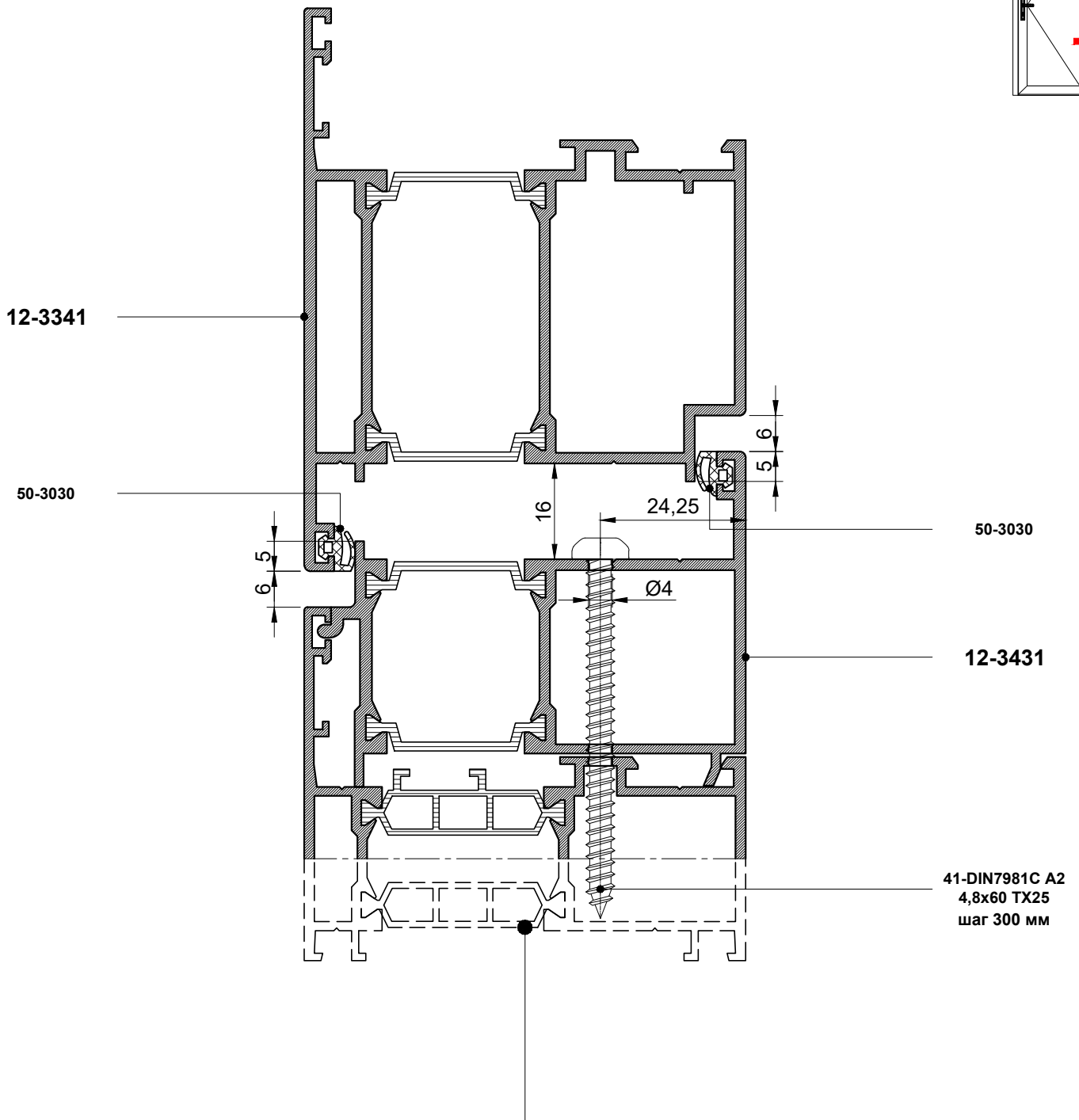
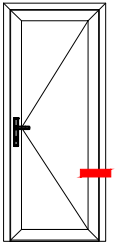

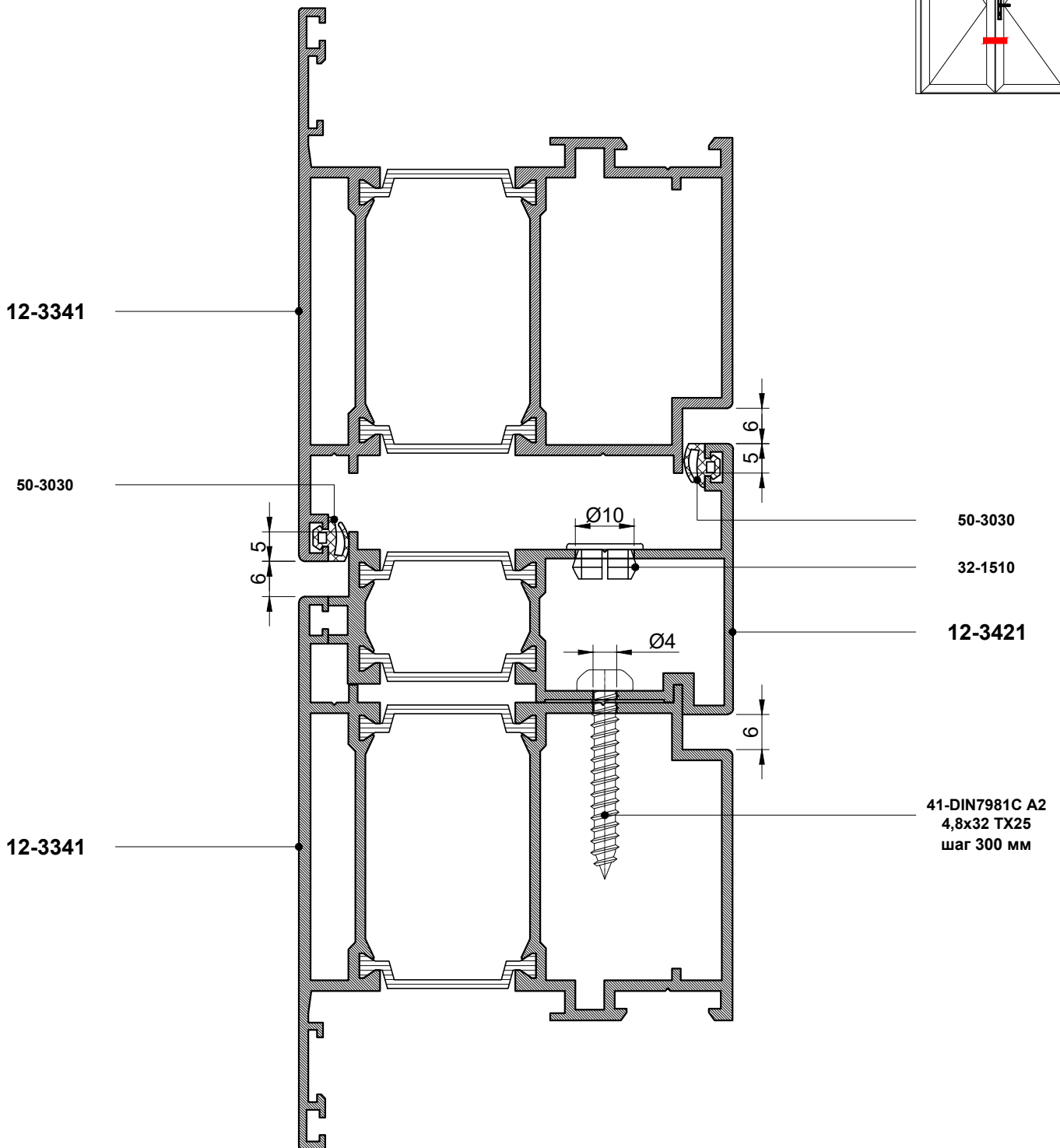
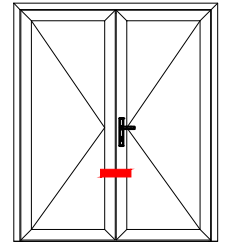

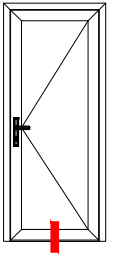

12-3341

50-3030

12-3172

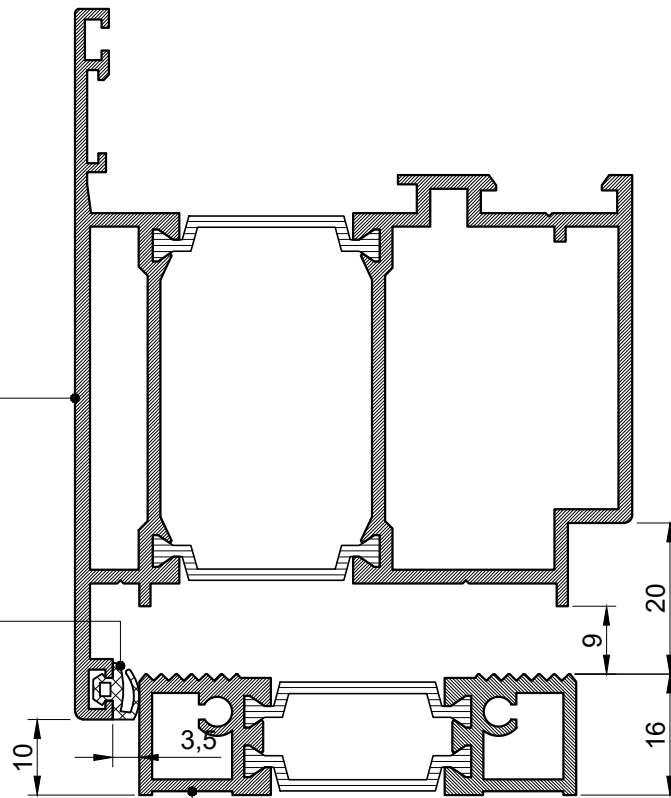

12-3341

50-3030

12-3171

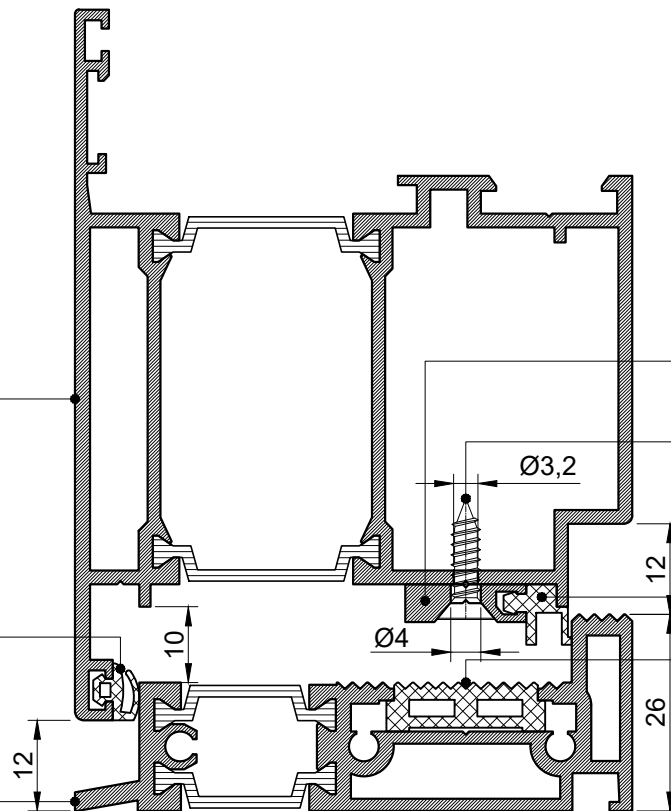

10-5201

43-DIN7982C A2
3,9x16 TX15
шаг 200 мм

50-3060

51-2002



12-3341

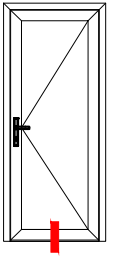
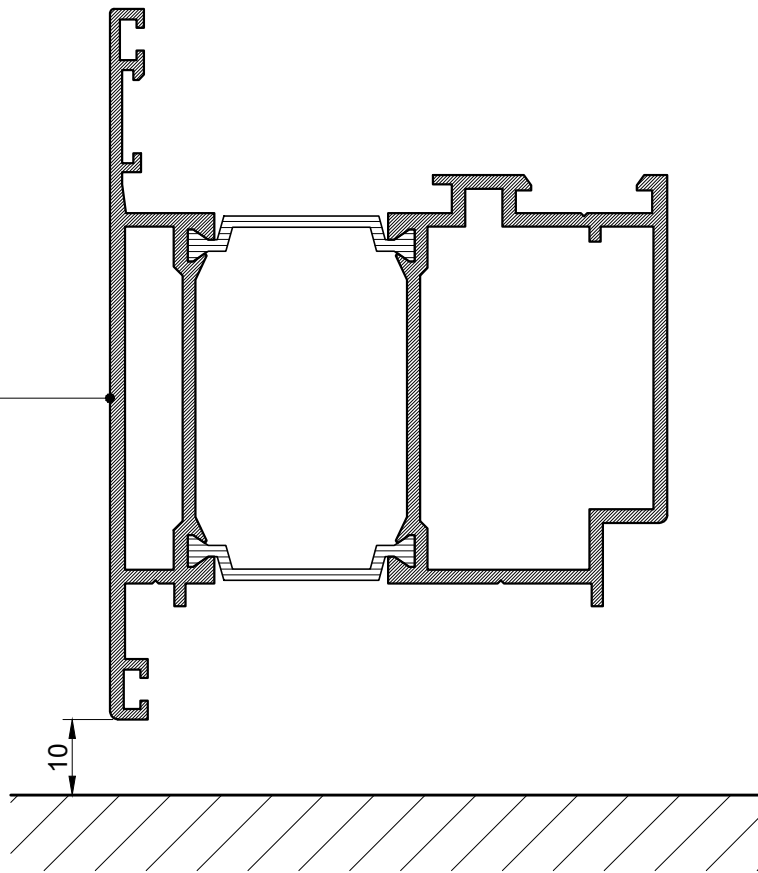

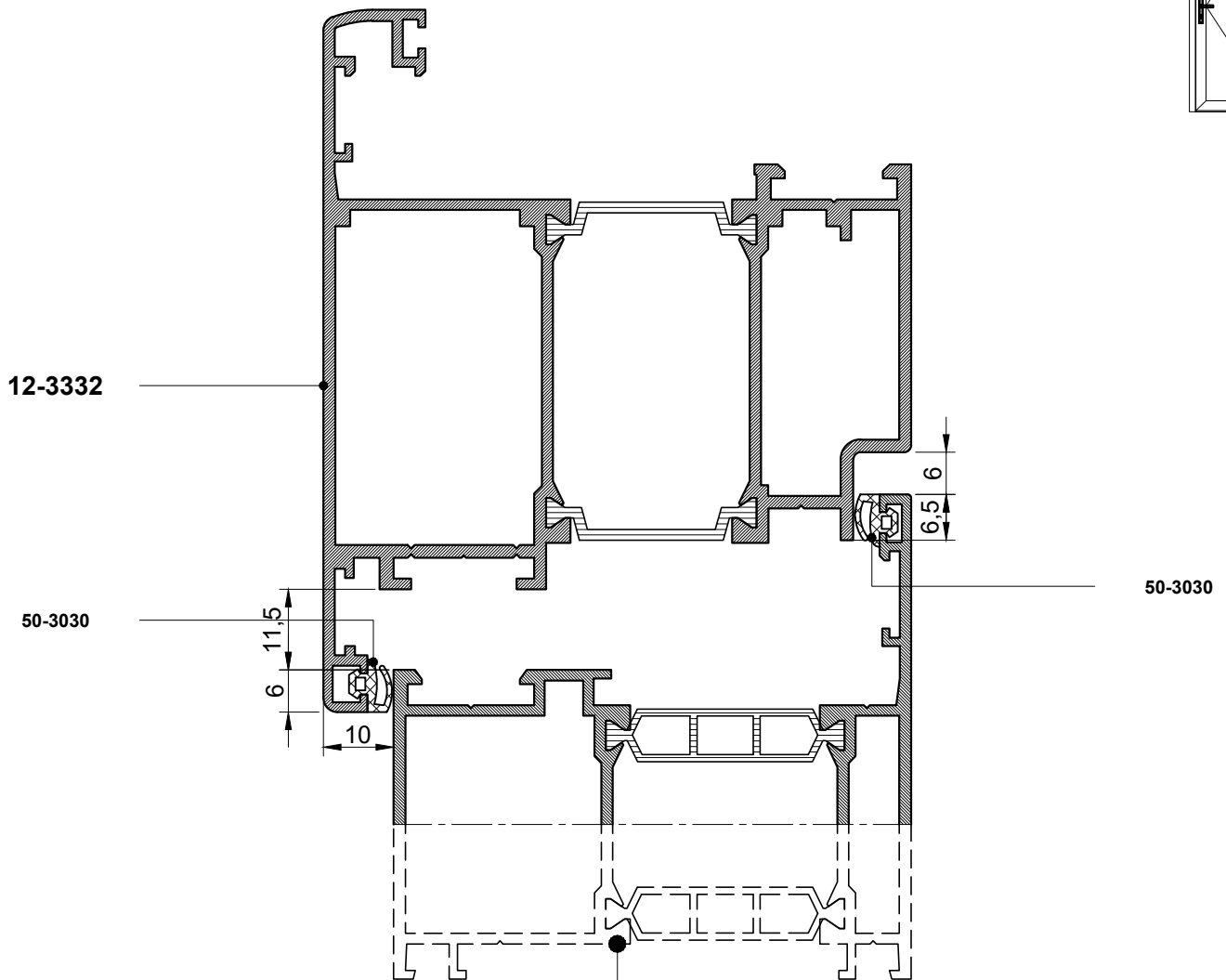
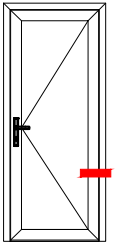

12-3111

12-3131

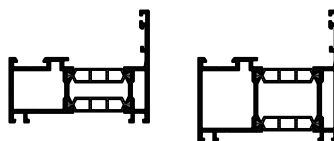

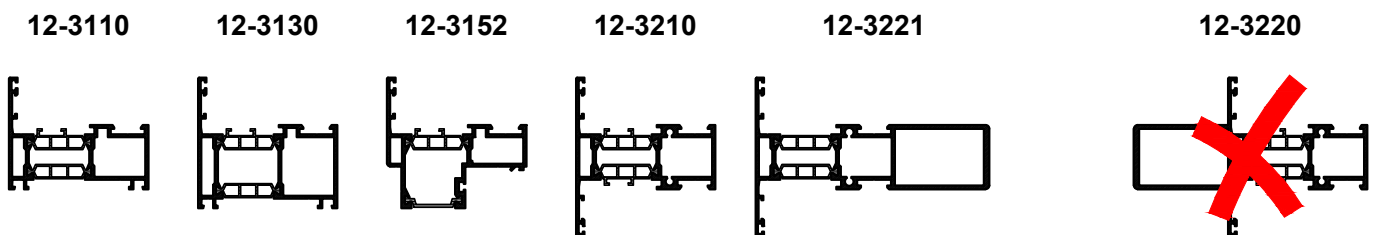
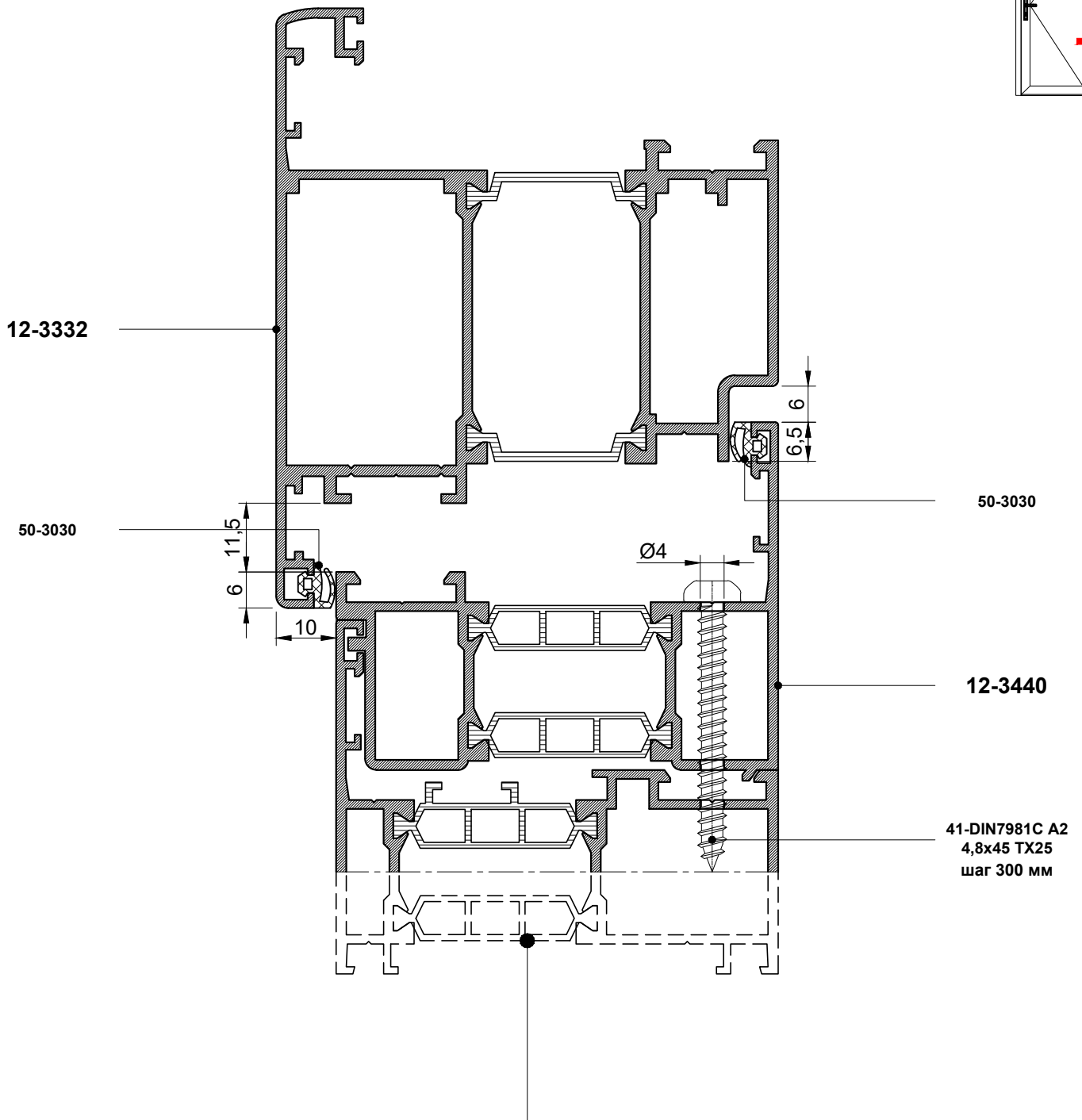
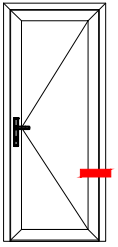

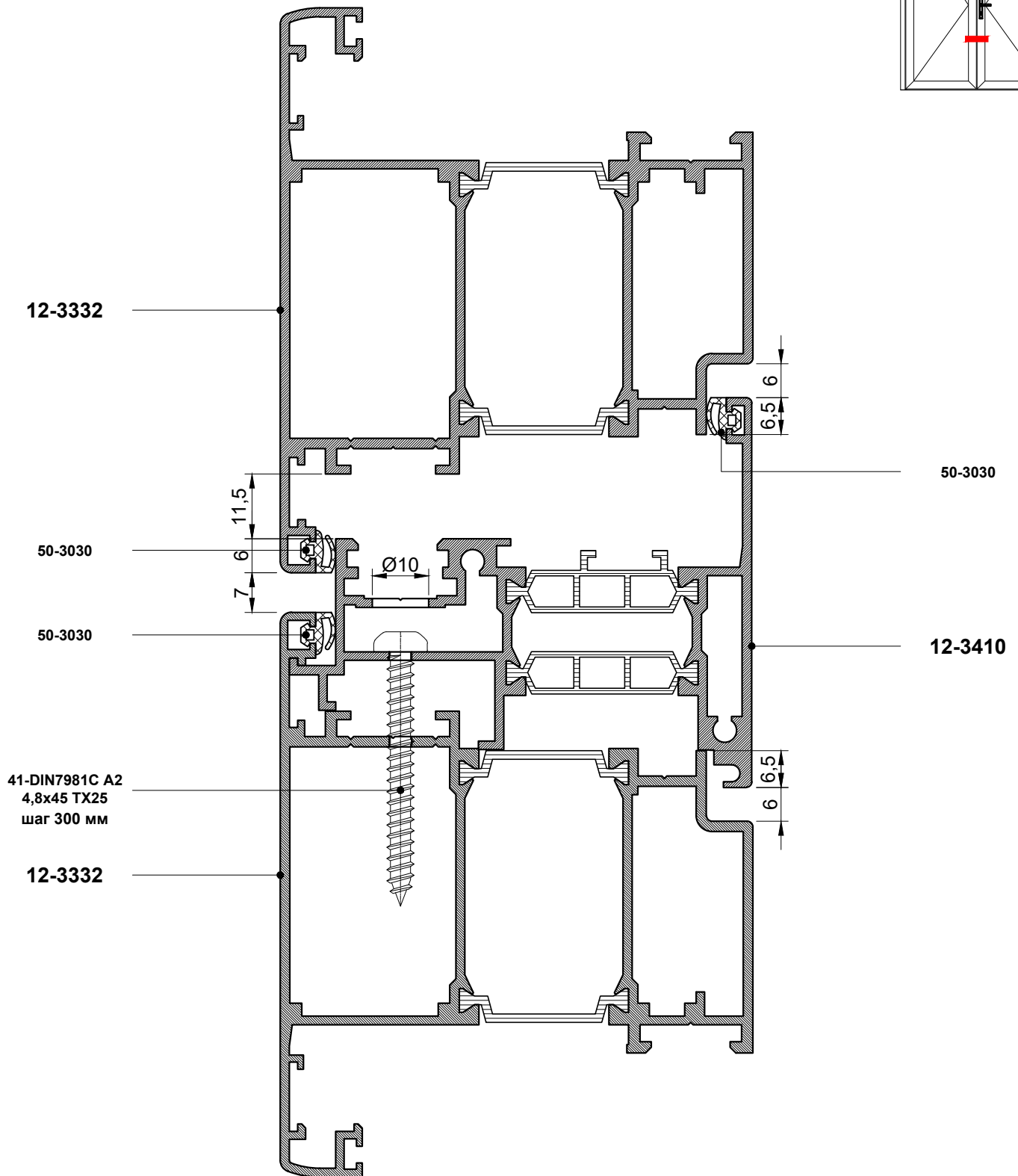
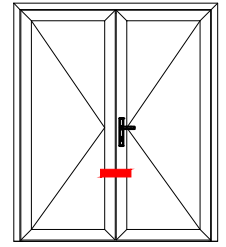

12-3141

12-3152

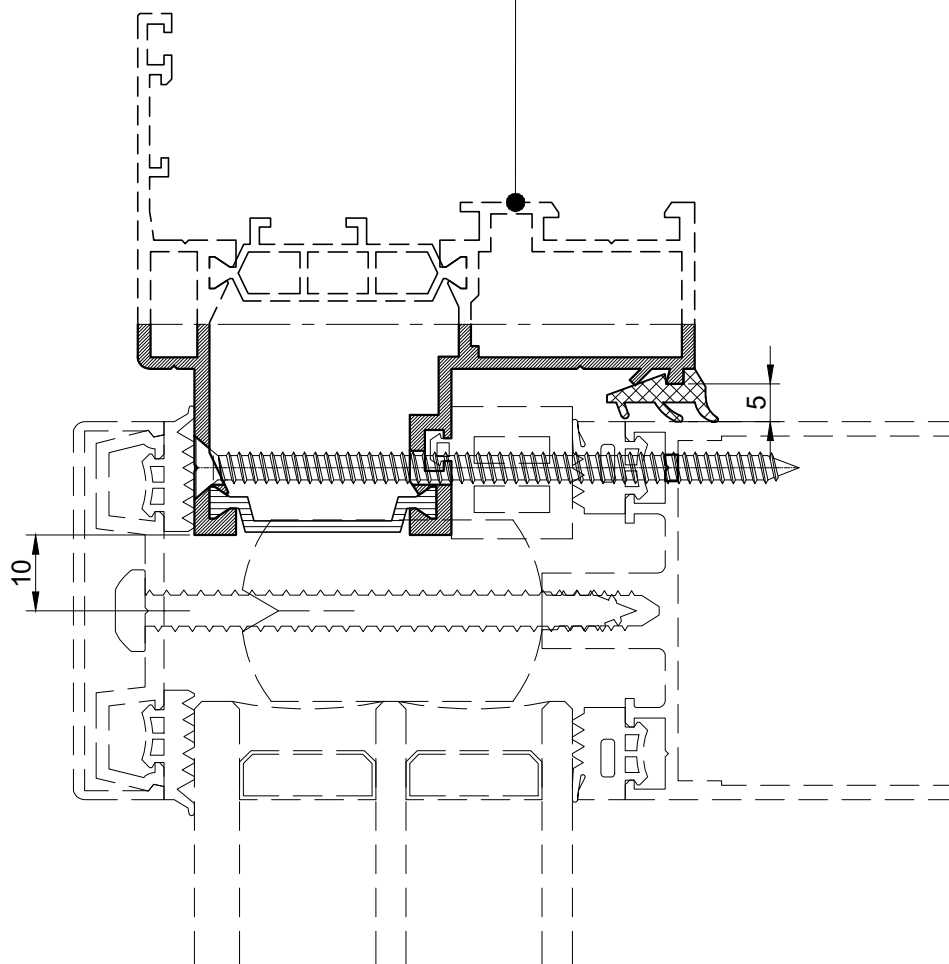
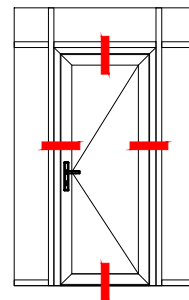
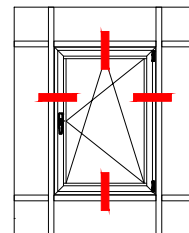
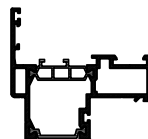
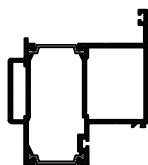

Смотри каталог F50



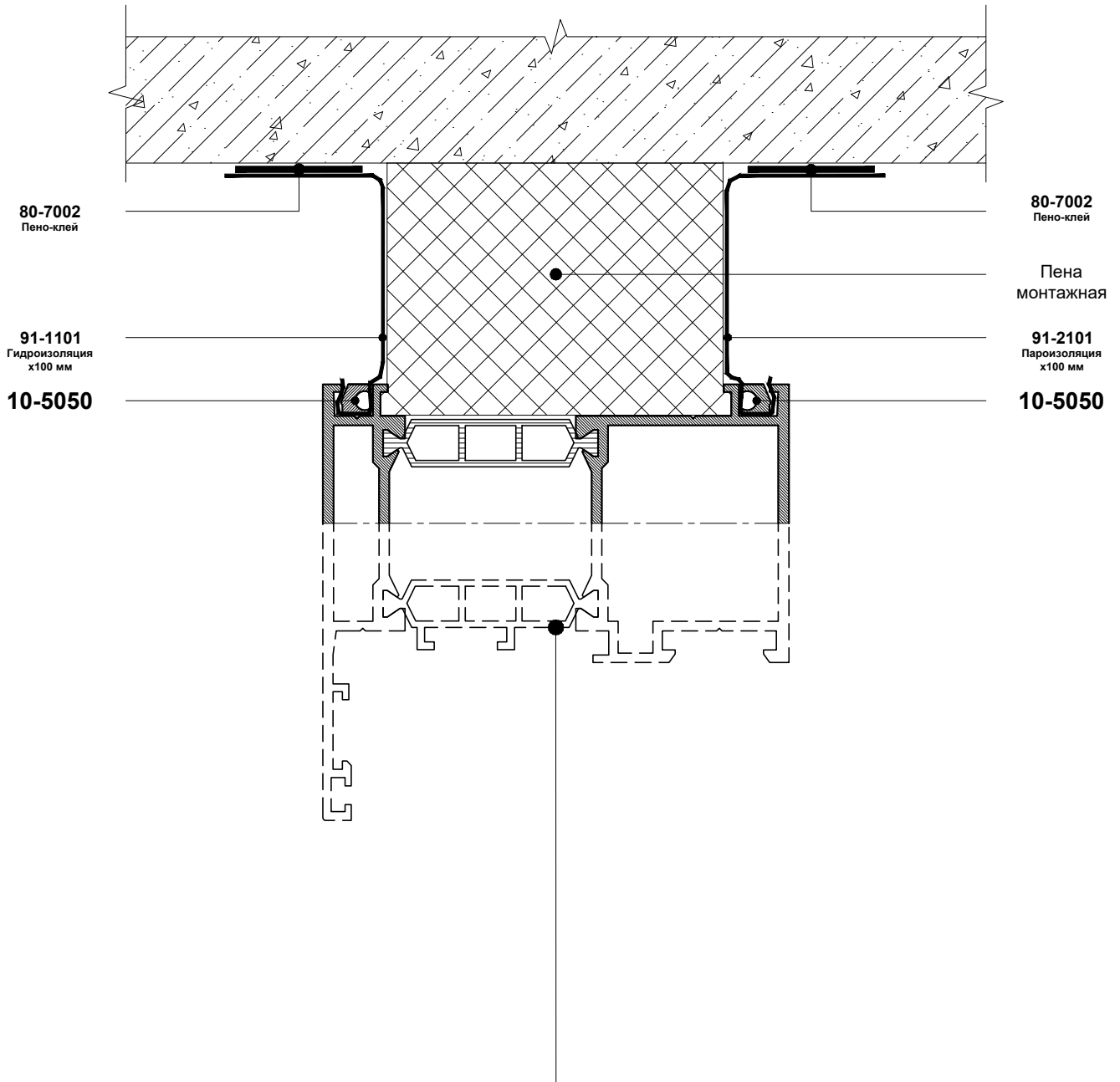
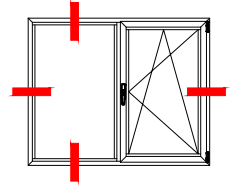

12-3110

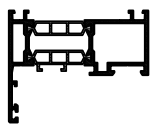

12-3111

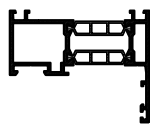

12-3122

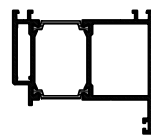

12-3130

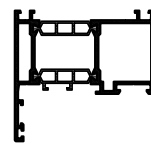

12-3131

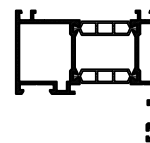

12-3110

12-3111

12-3122

12-3130

12-3131

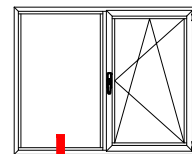
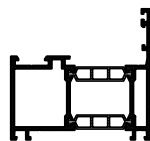
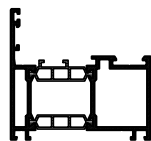
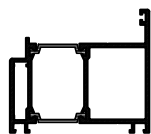
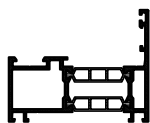
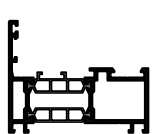

10-5050

91-1101
Гидроизоляция
x100 мм

80-7002
Пено-клей

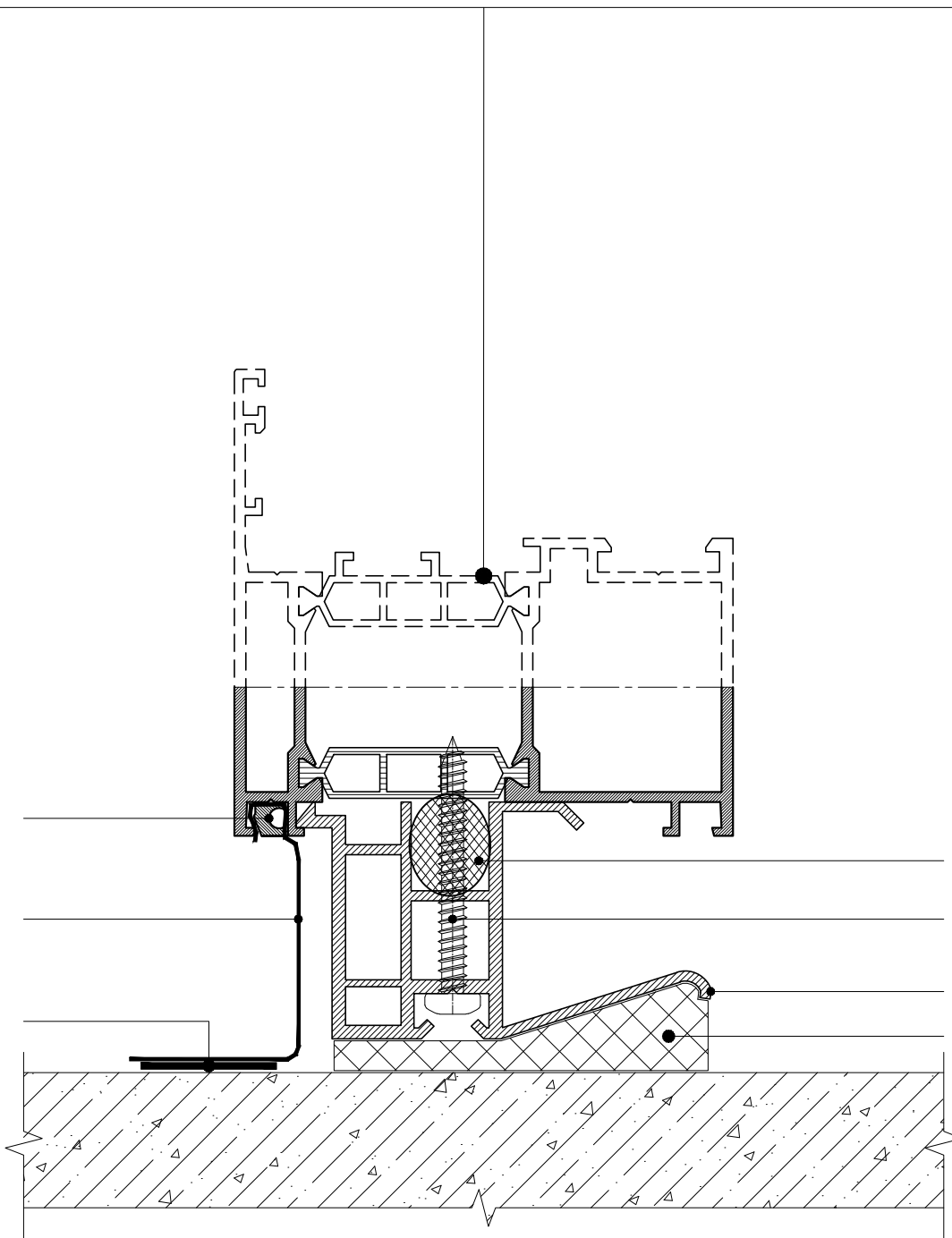

52-0150

41-DIN7981C A2
4,2x38 TX20
шаг 300 мм

65-1001

Пена
монтажная



12-3110

12-3111

12-3122

12-3130

12-3131

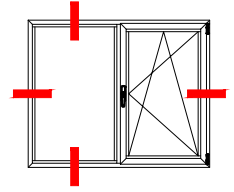
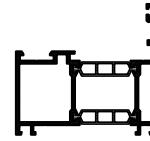
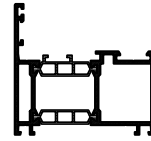
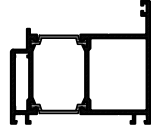
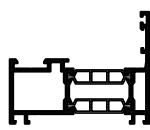
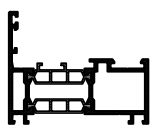

80-6002
Клей гибридный полимерный
blaugelb Power Fix

10-5050

91-1101
Гидроизоляция
x100 мм

65-1005
Trioterm
35x52 мм

80-7002
Пено-клей

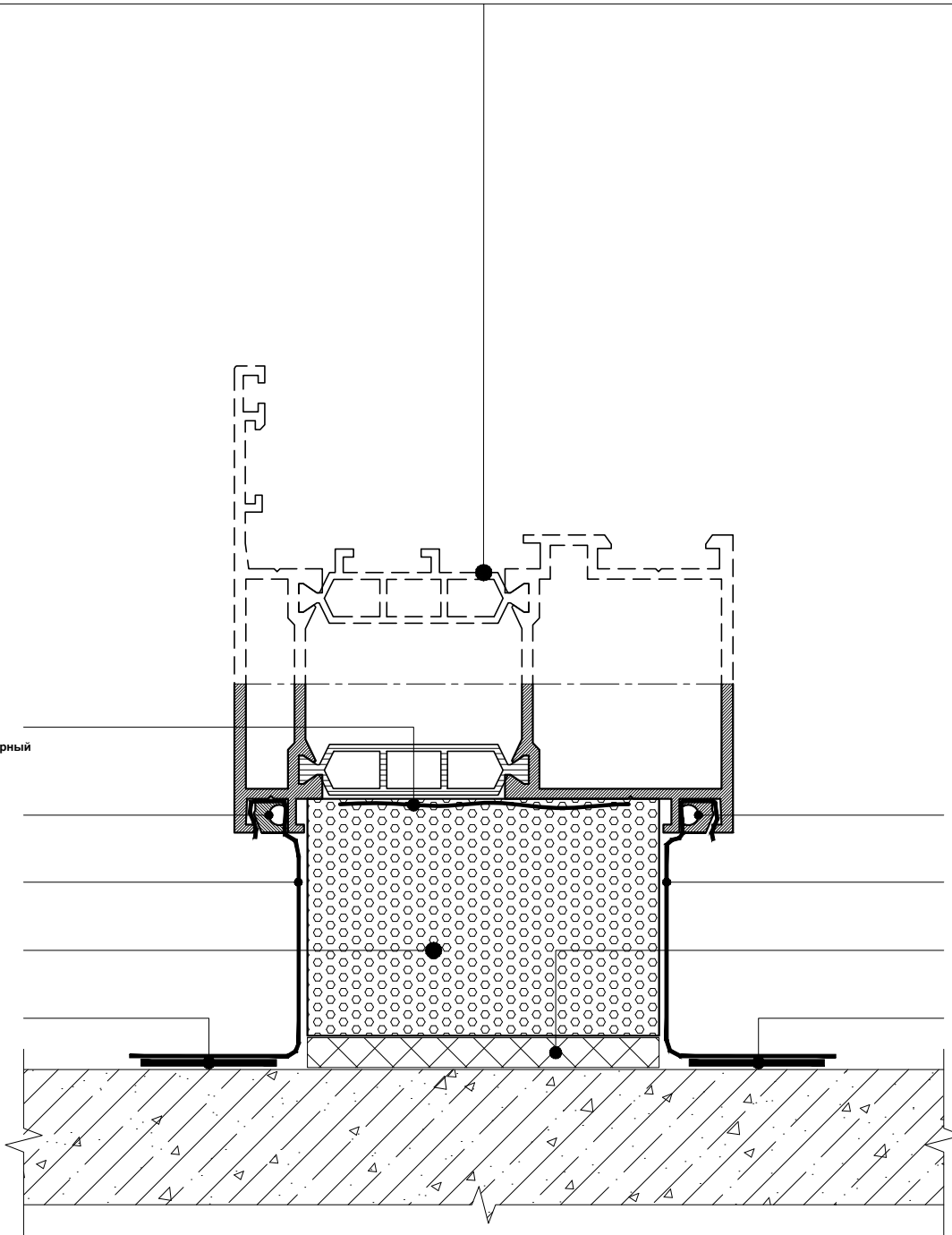

10-5050

91-2101
Пароизоляция
x100 мм

Пена
МОНТАЖНАЯ

80-7002
Пено-клей



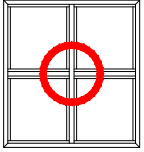
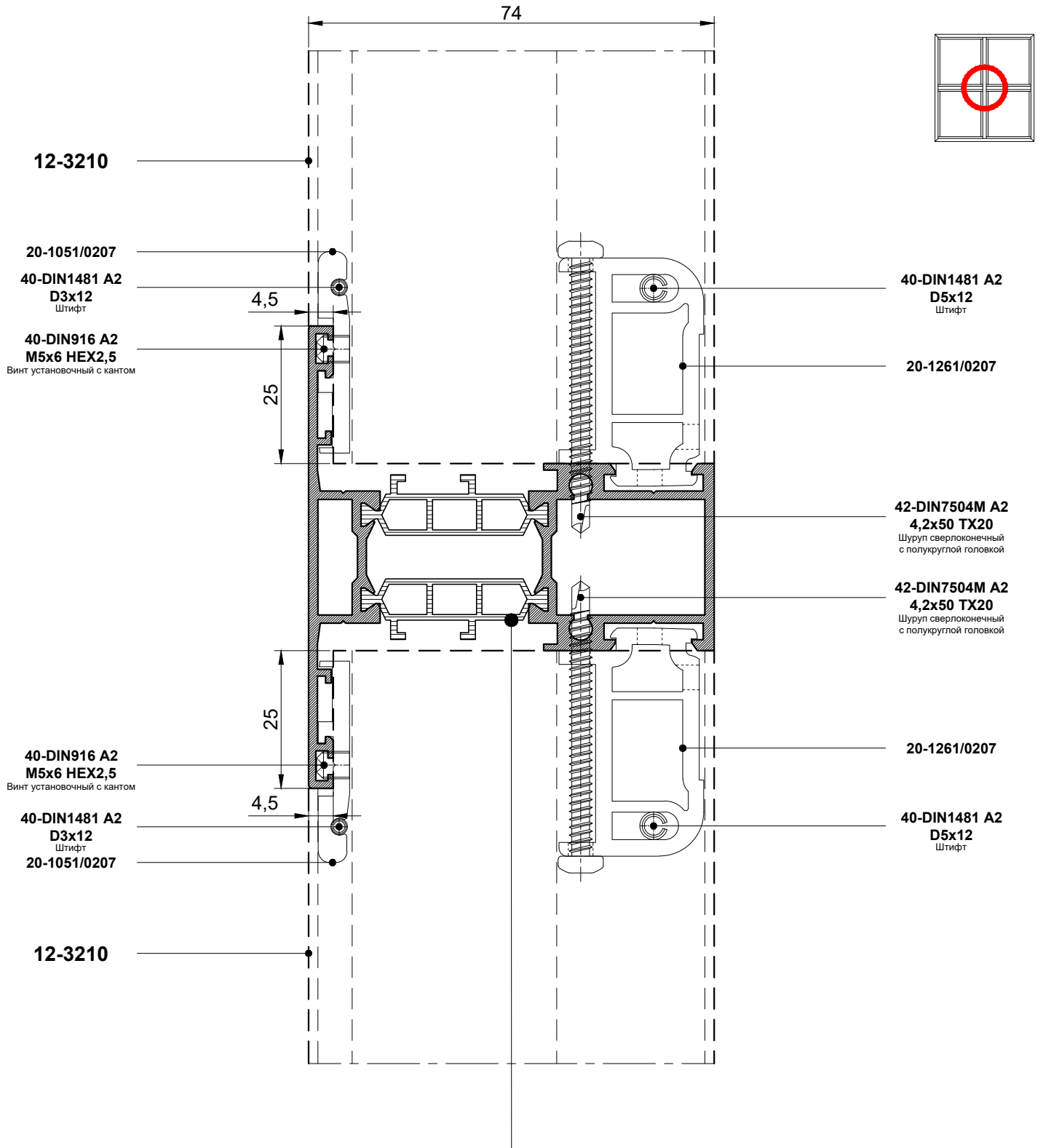

12-3210

12-3220

12-3221

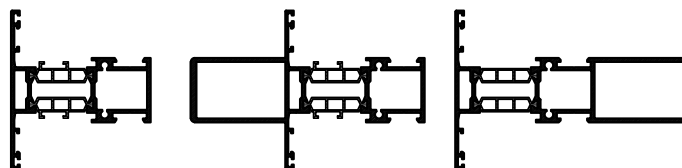

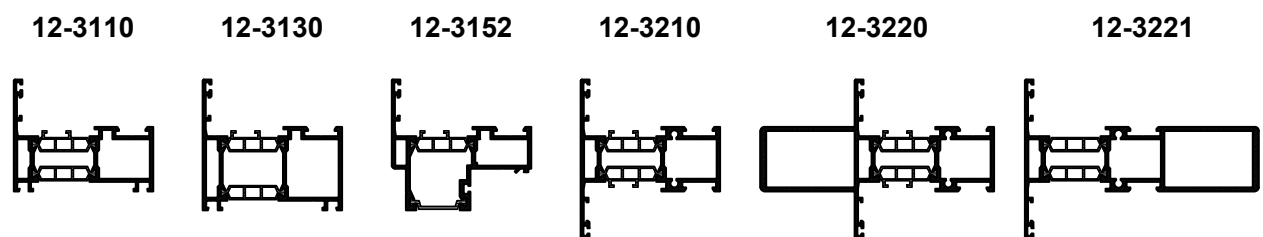
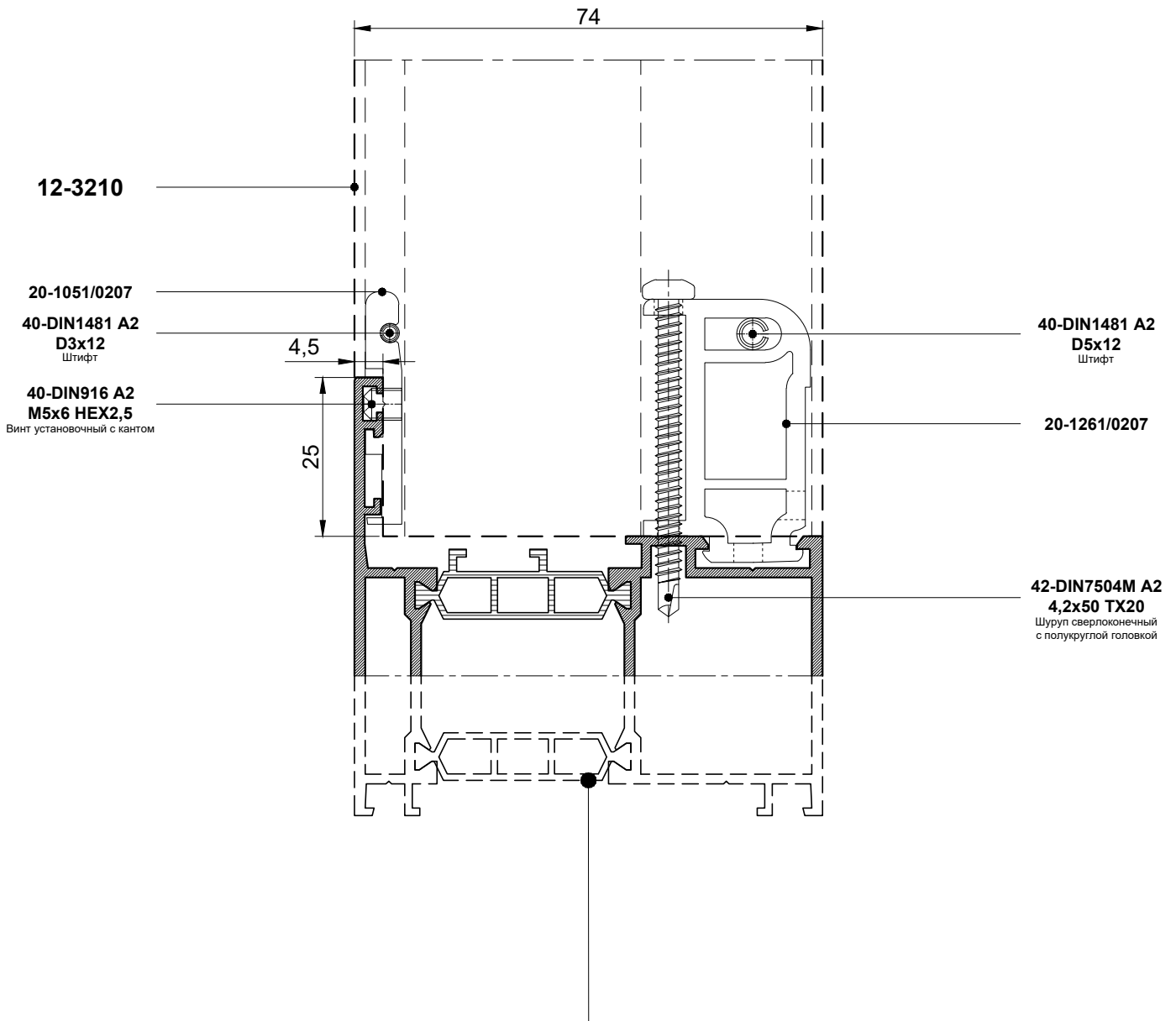
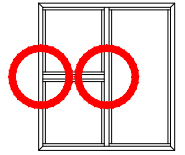

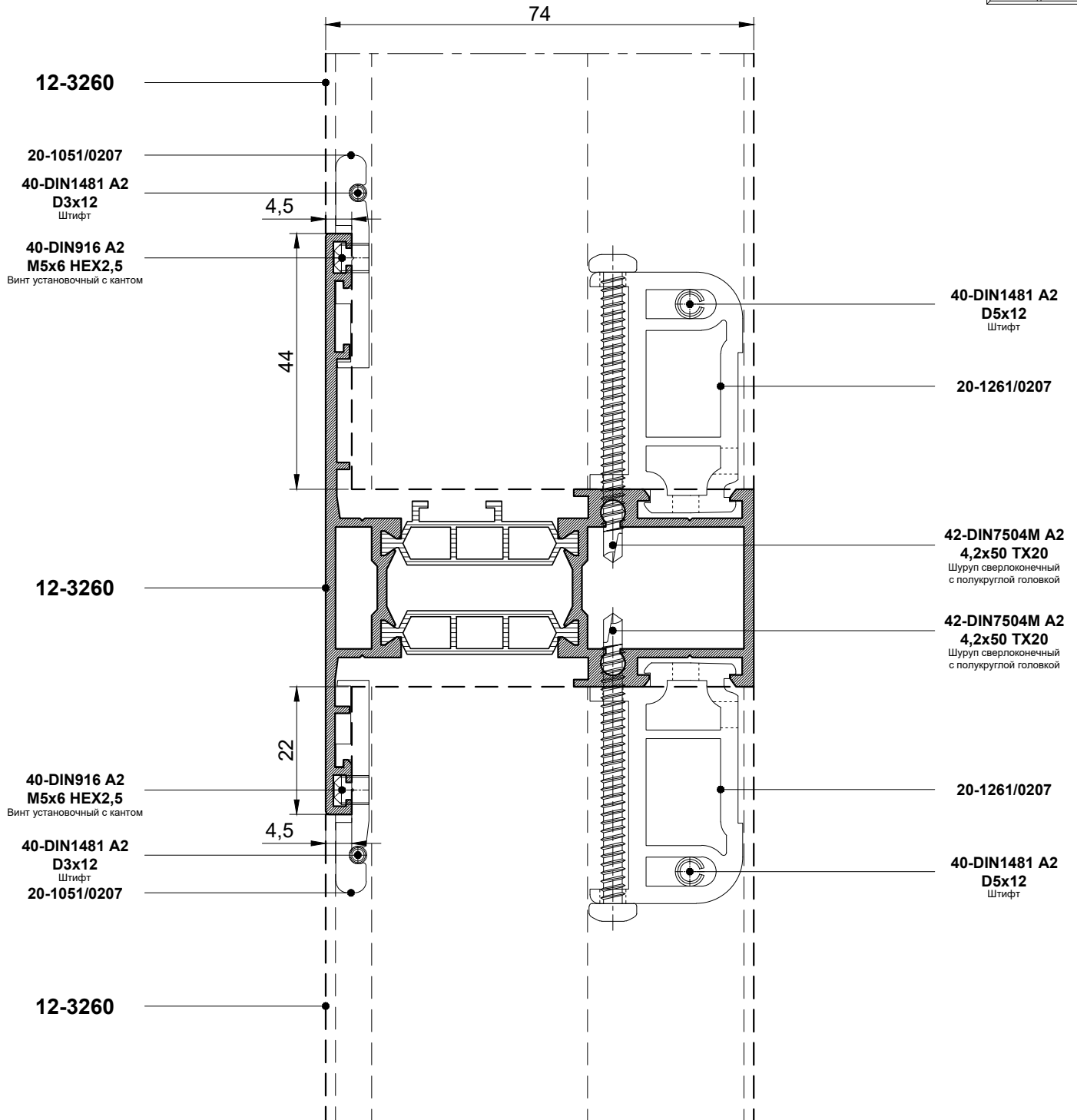
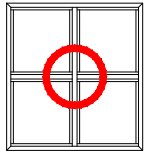

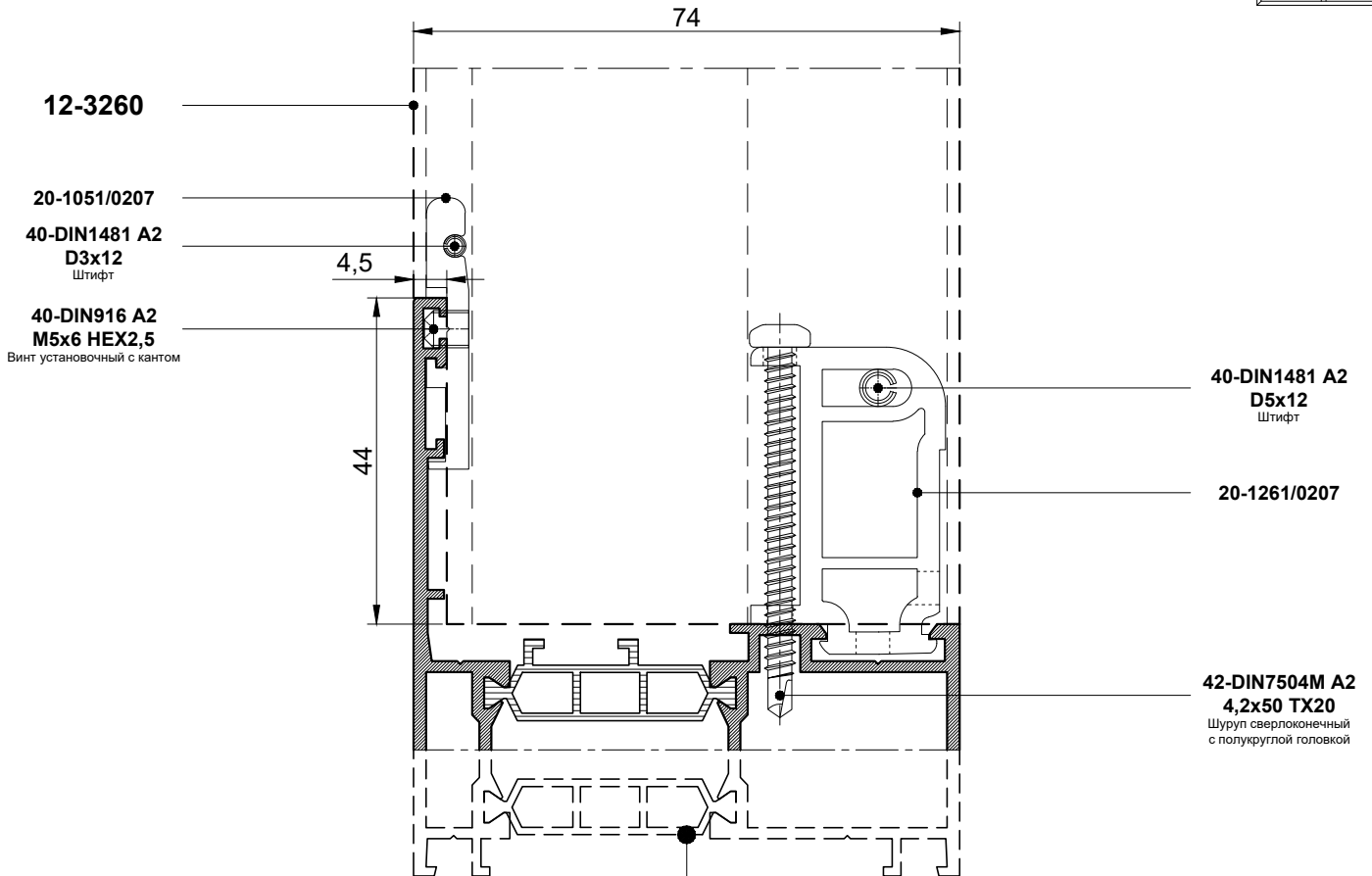
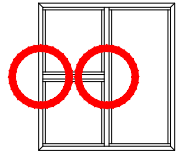

12-3160

12-3260

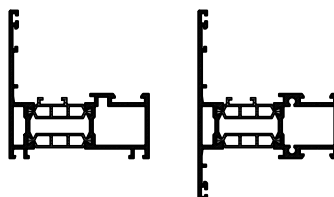

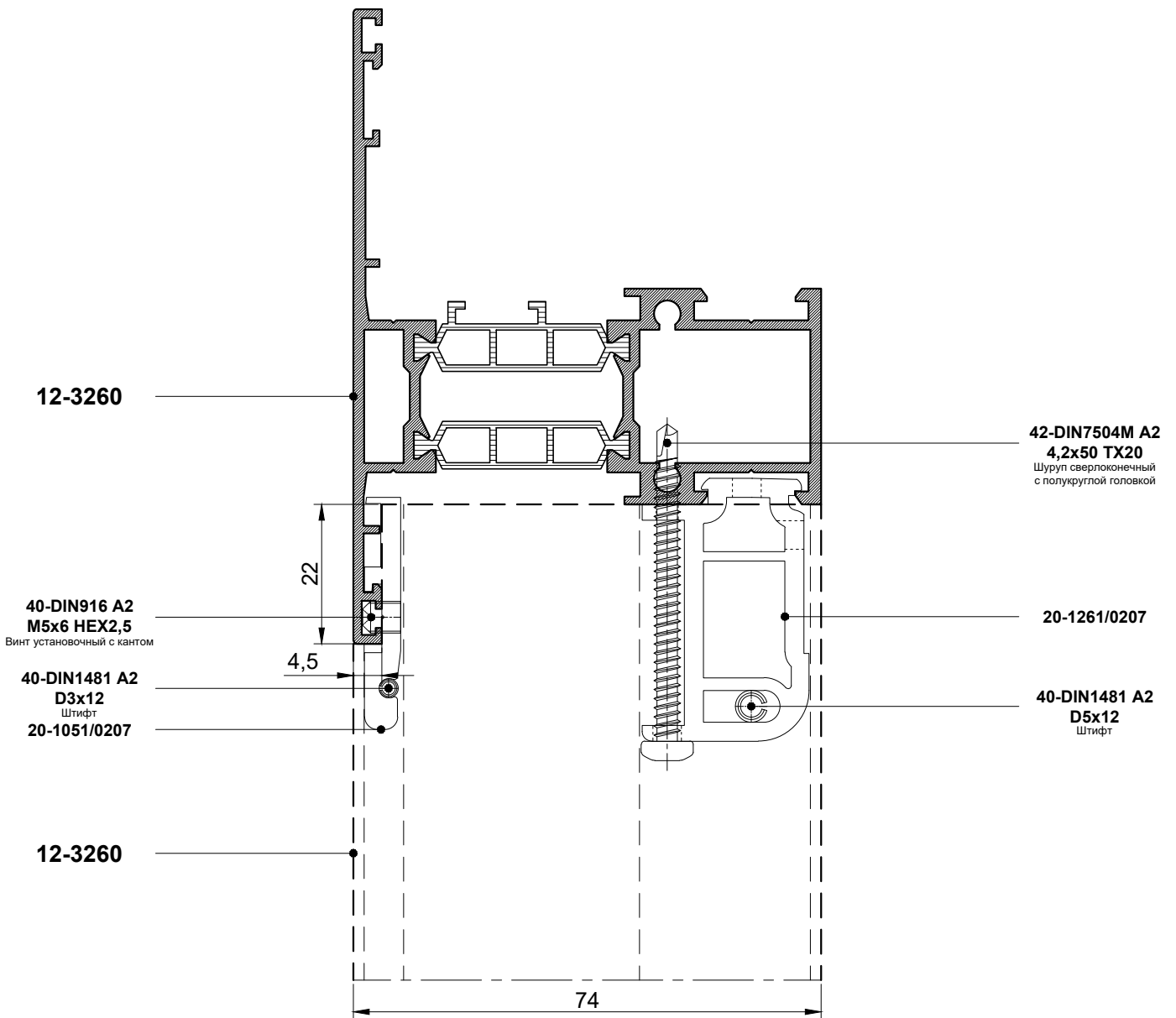
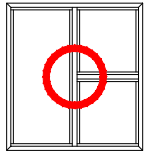

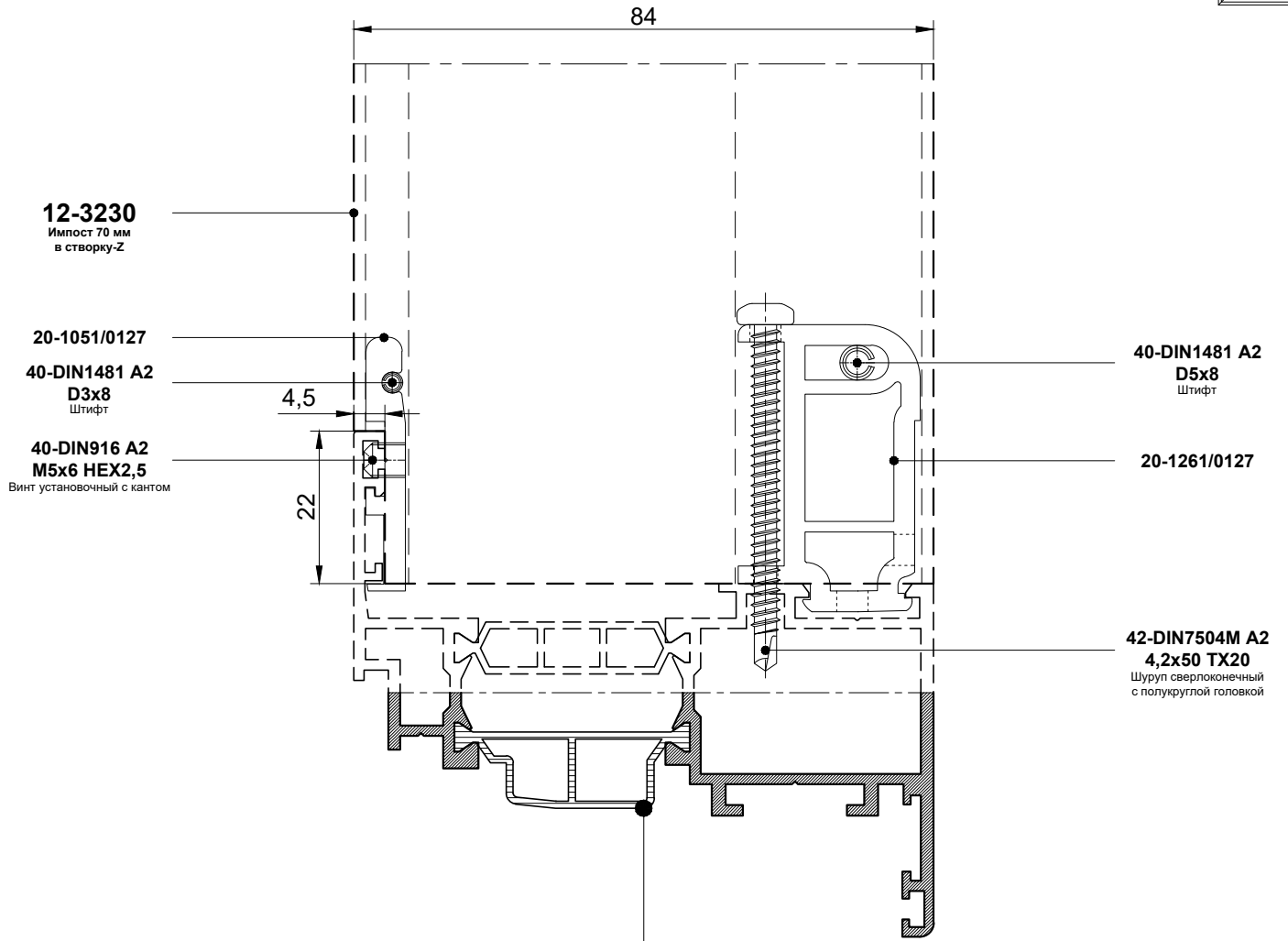
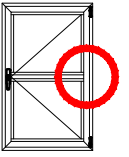

12-3310

12-3320

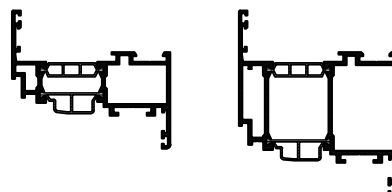

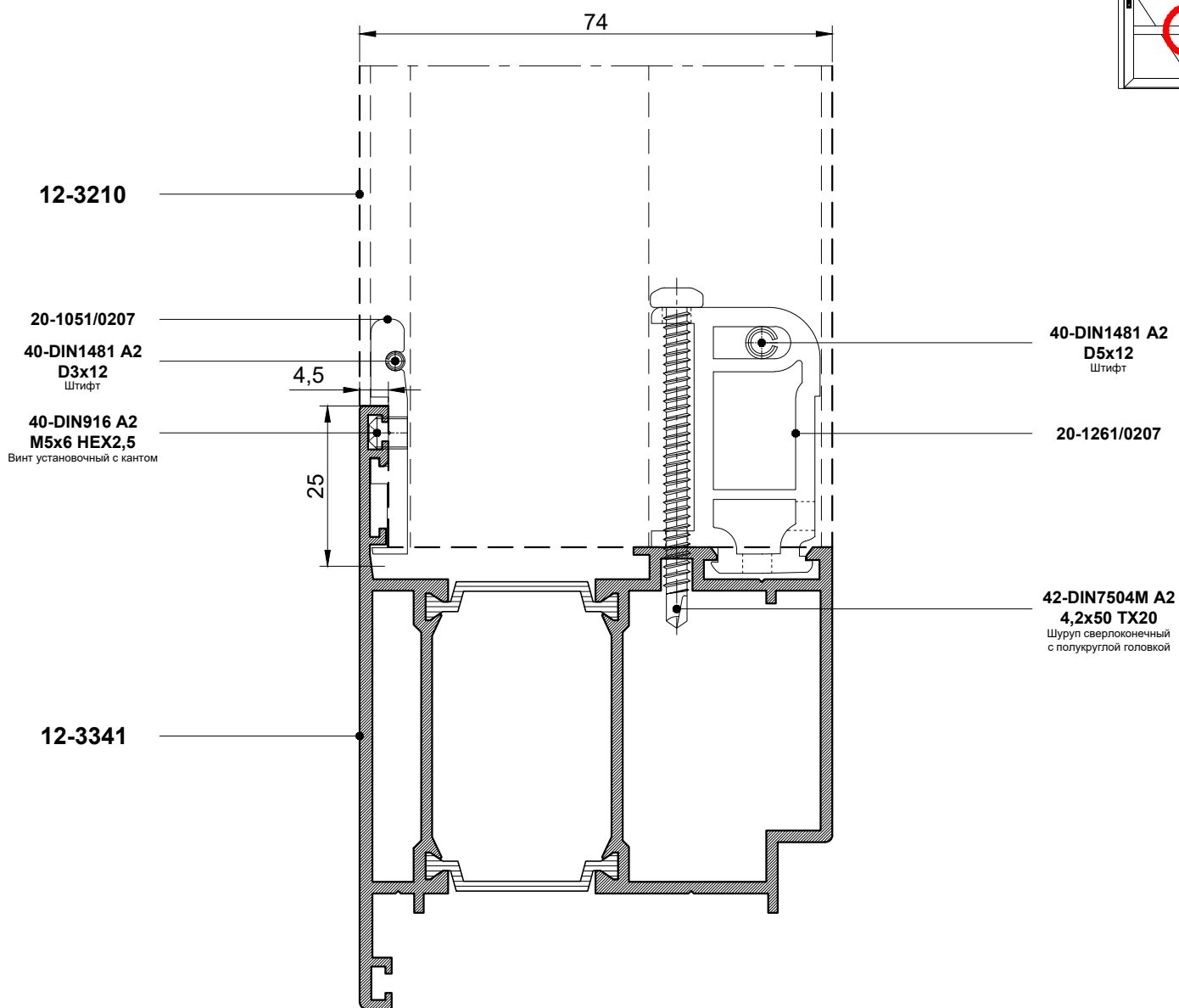
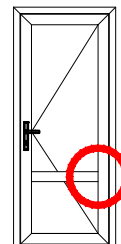

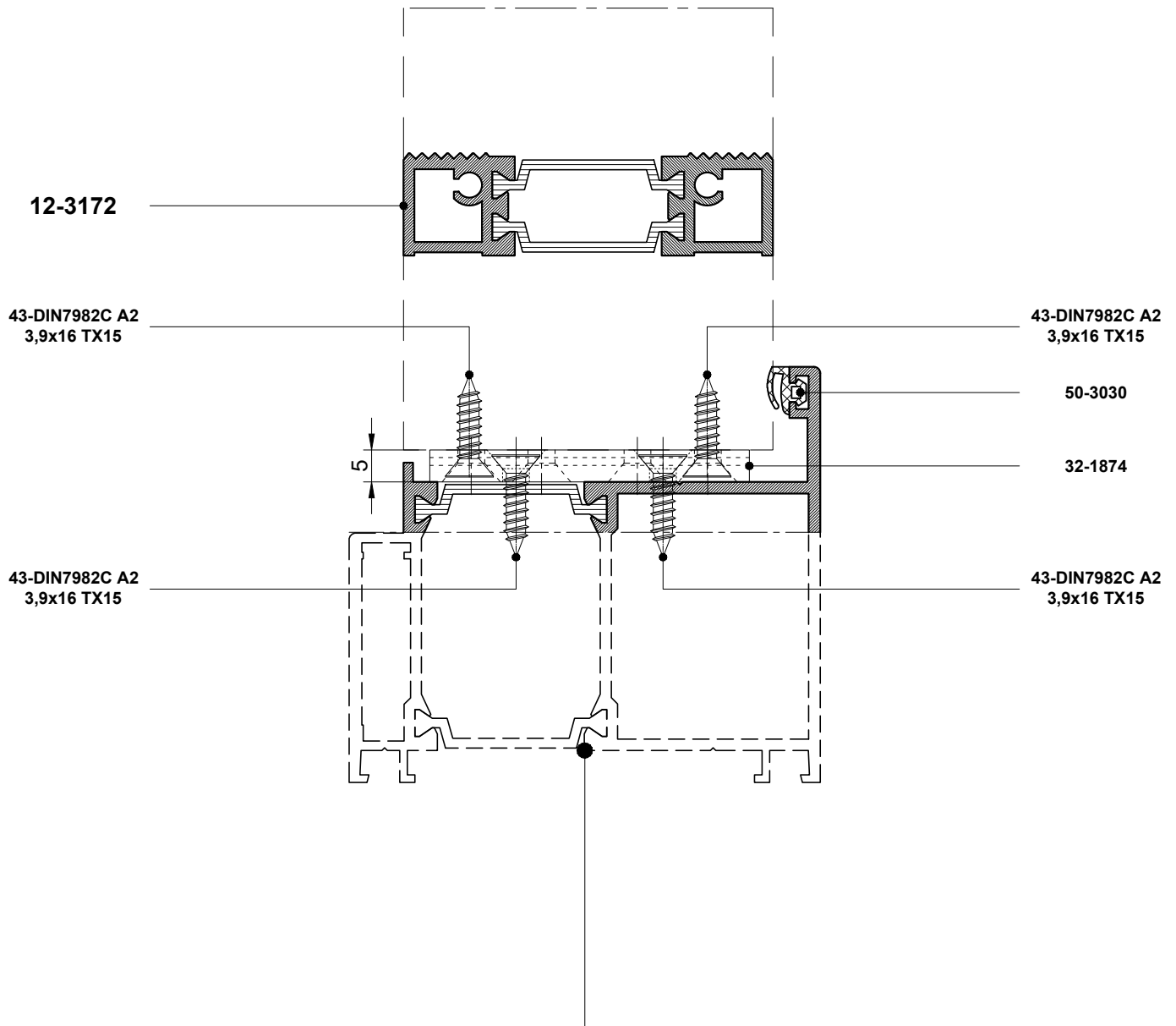
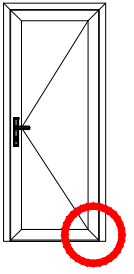

12-3122

12-3141

12-3431

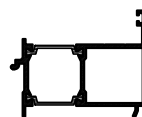
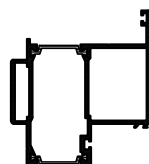
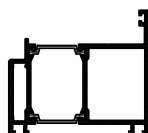

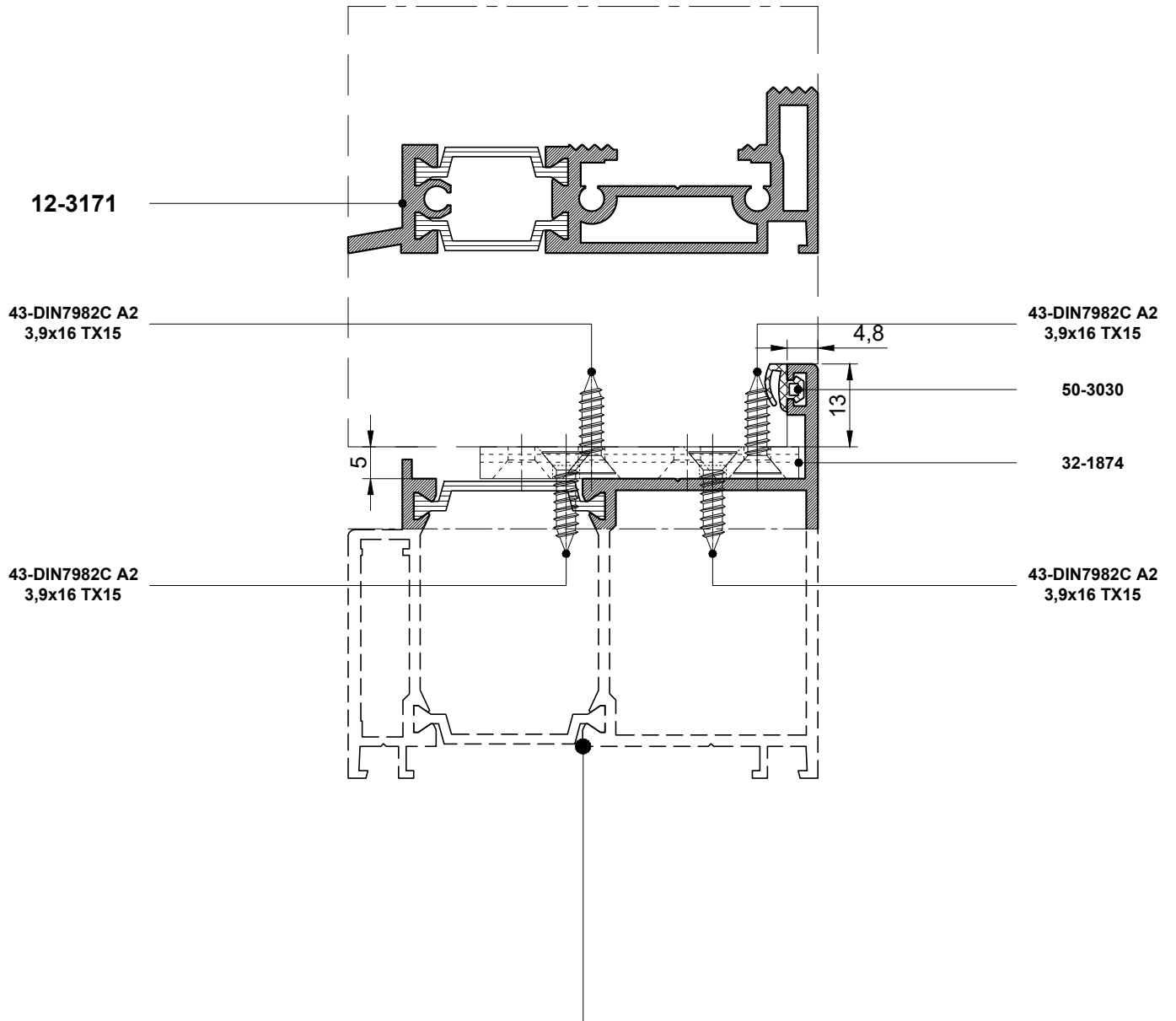
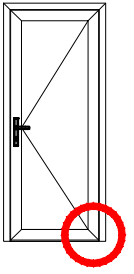

12-3122

12-3141

12-3431

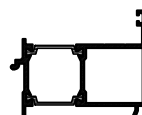
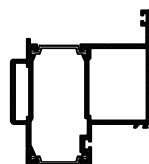
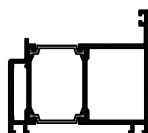

12-3110

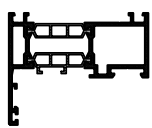

12-3130

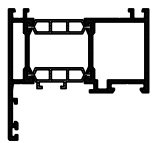

12-3152

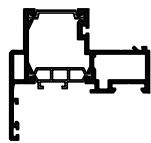

12-3210

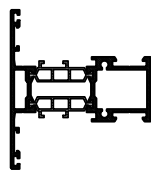

12-3220

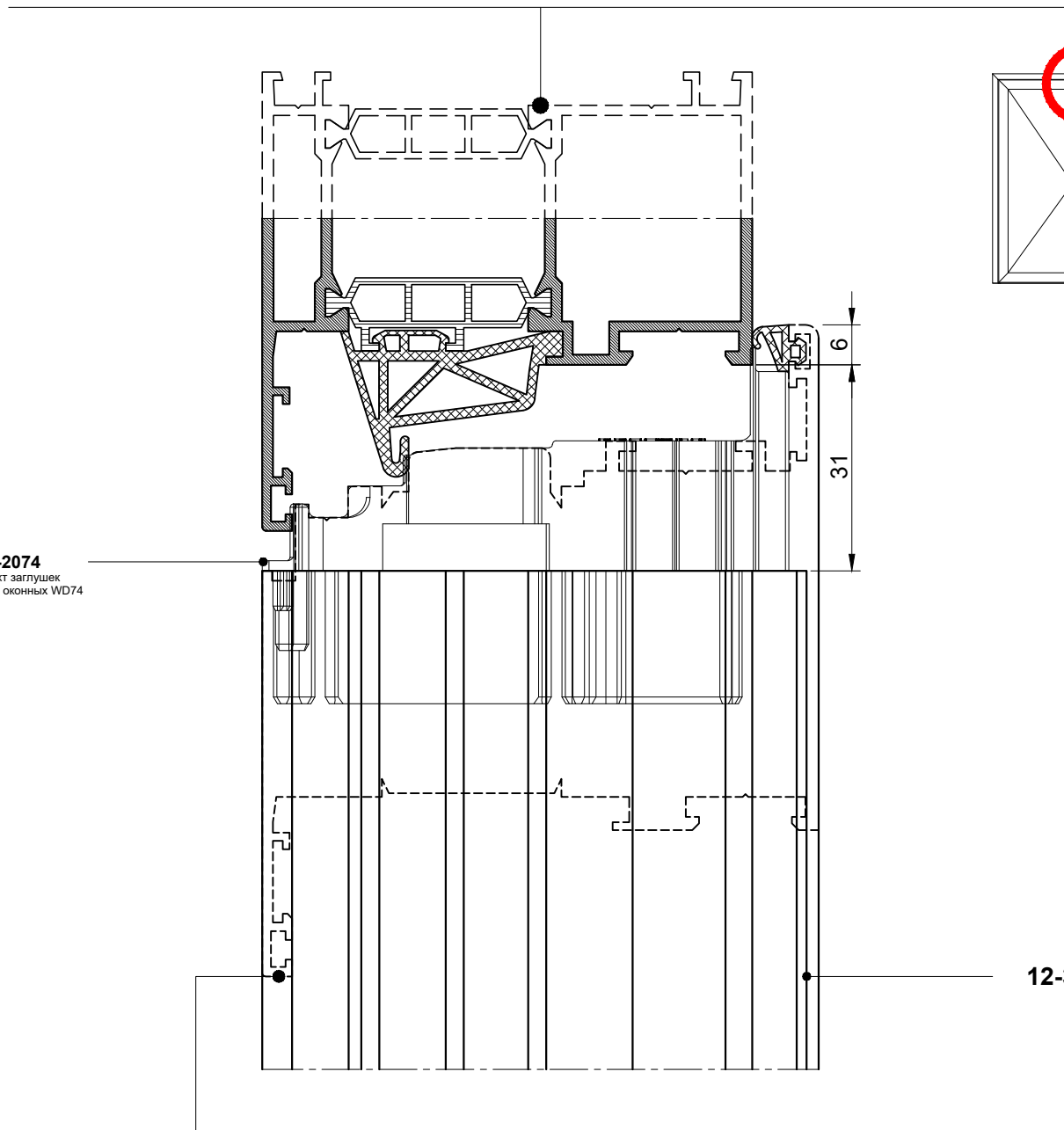
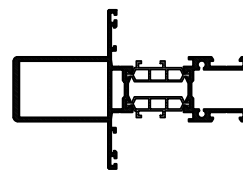

33-2074
Комплект заглушек
штульповых оконных WD74

12-3410

12-3320

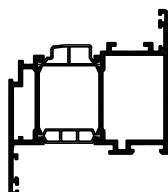

12-3122

12-3141

12-3431

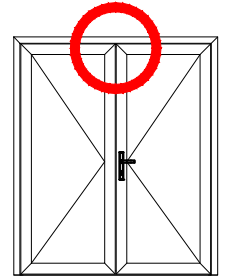
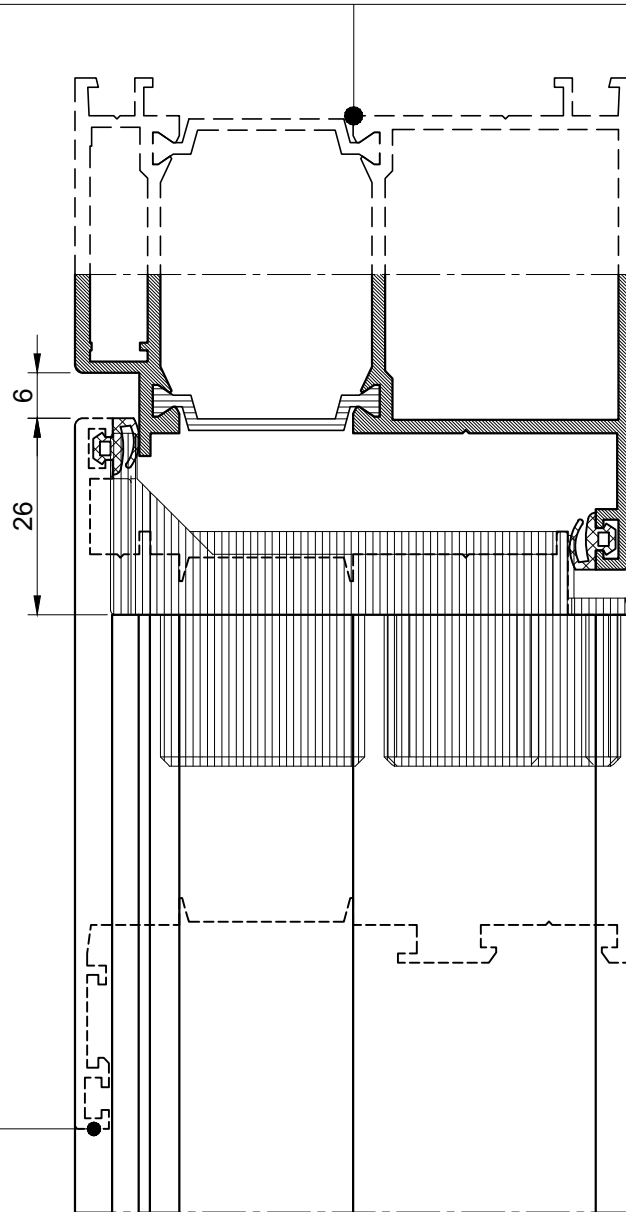
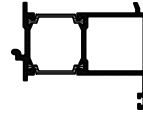
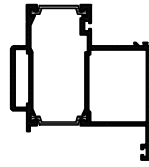
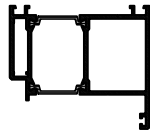

33-1974
Комплект заглушек
штупельных дверных WD74

12-3421

12-3341

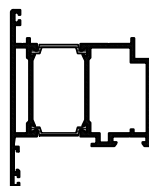

12-3341

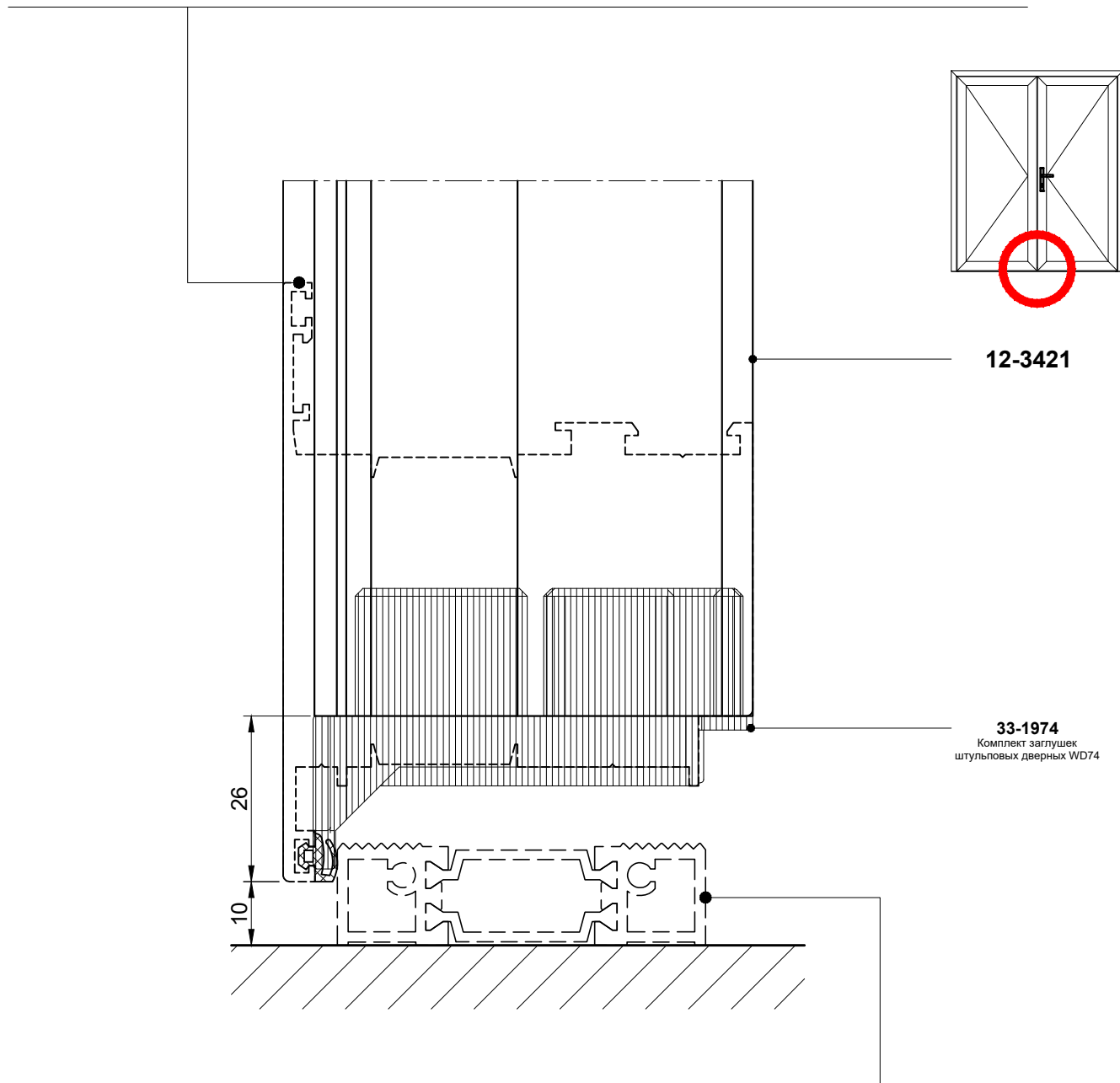
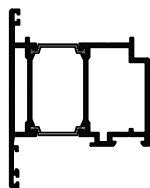

12-3421

33-1974
Комплект заглушек
штульповых дверных WD74

12-3172
(опция)

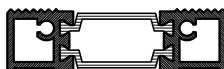

12-3341

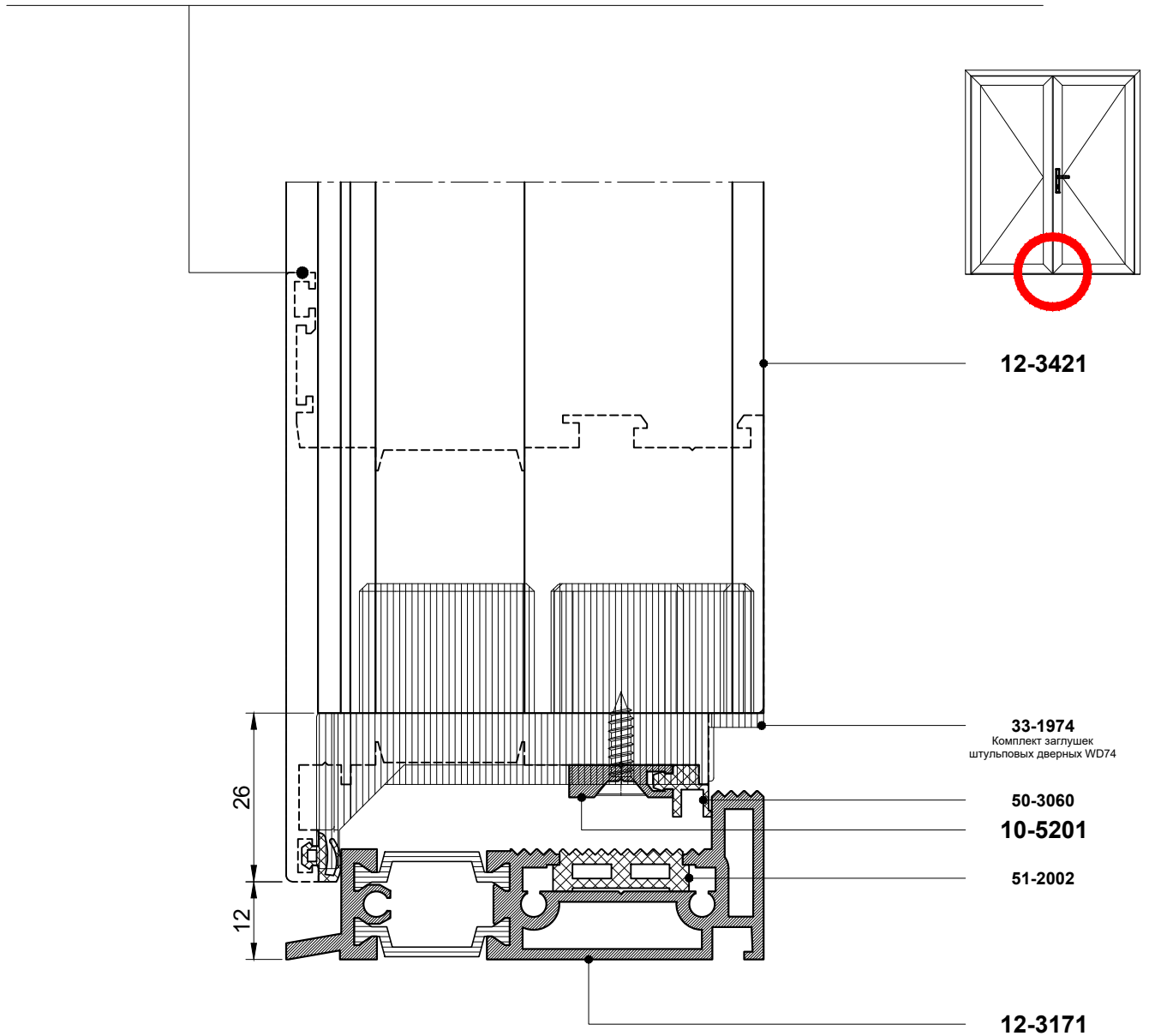
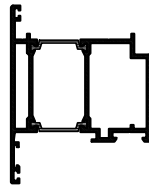

12-3111

12-3131

12-3440

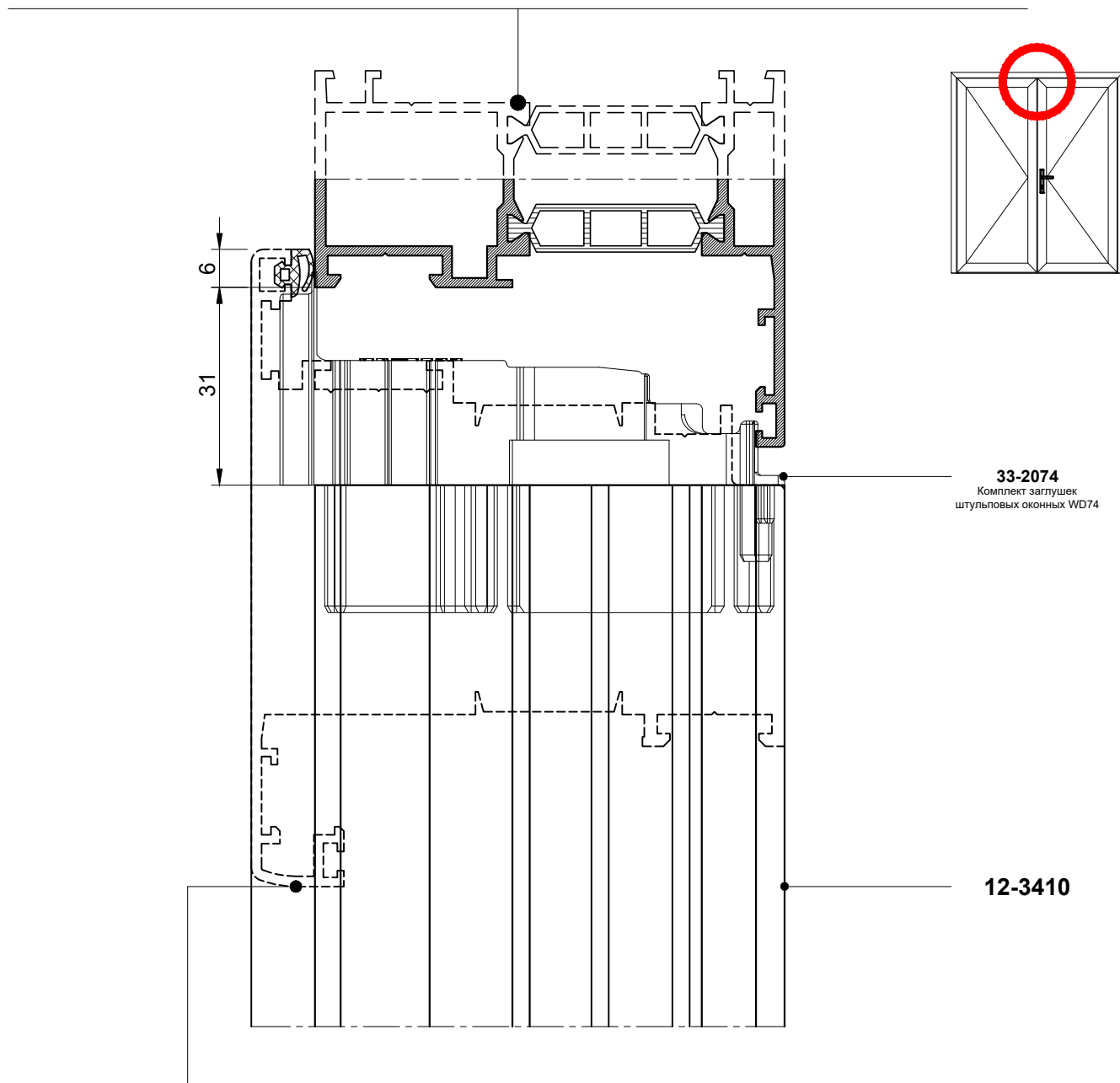
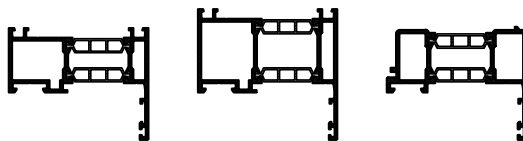

33-2074
Комплект заглушек
штульповых оконных WD74

12-3410

12-3332

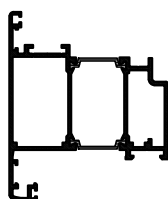

12-3332

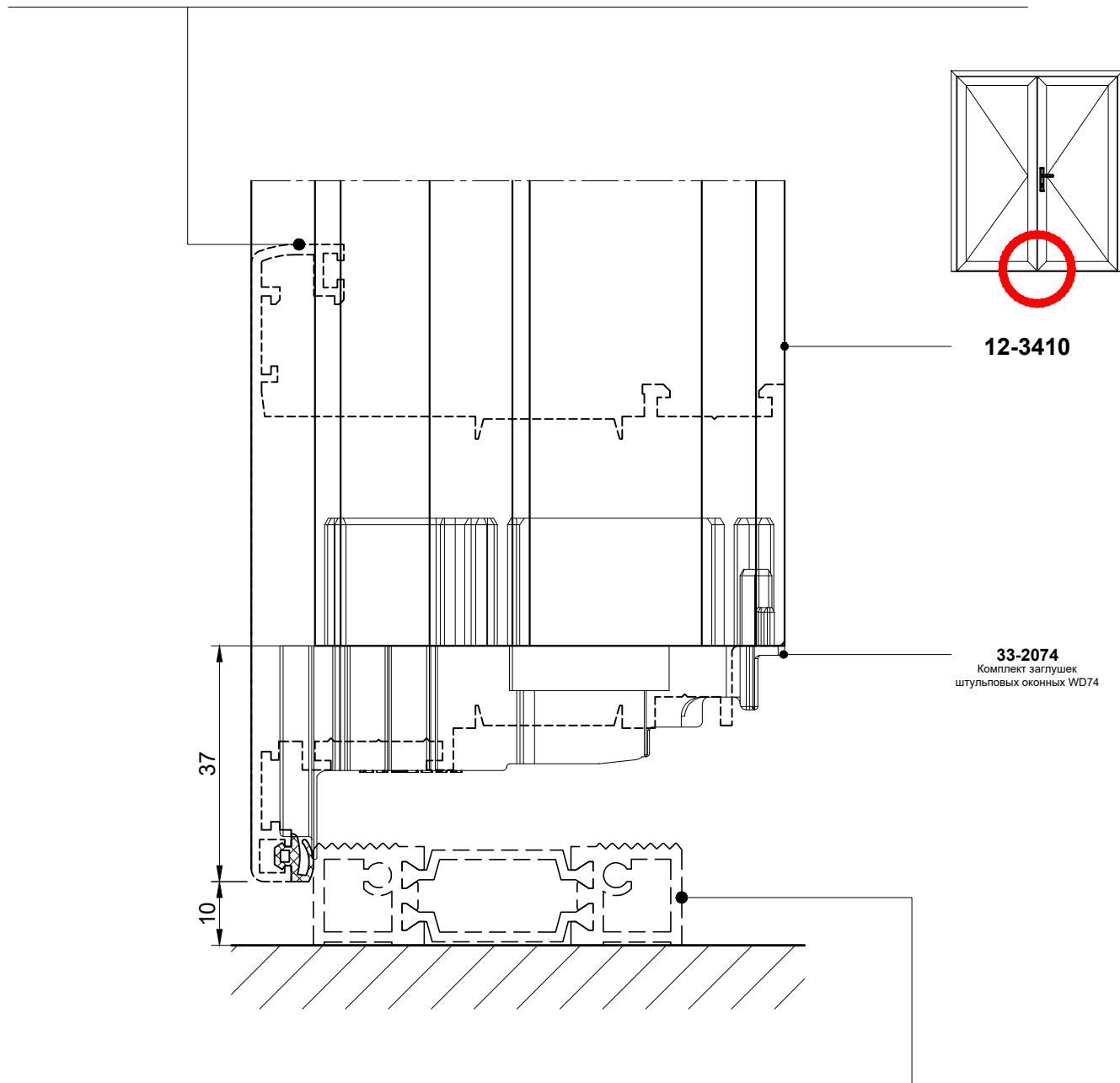
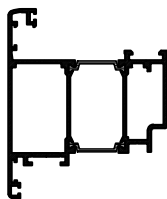

12-3172
(опция)

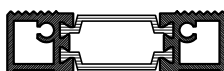

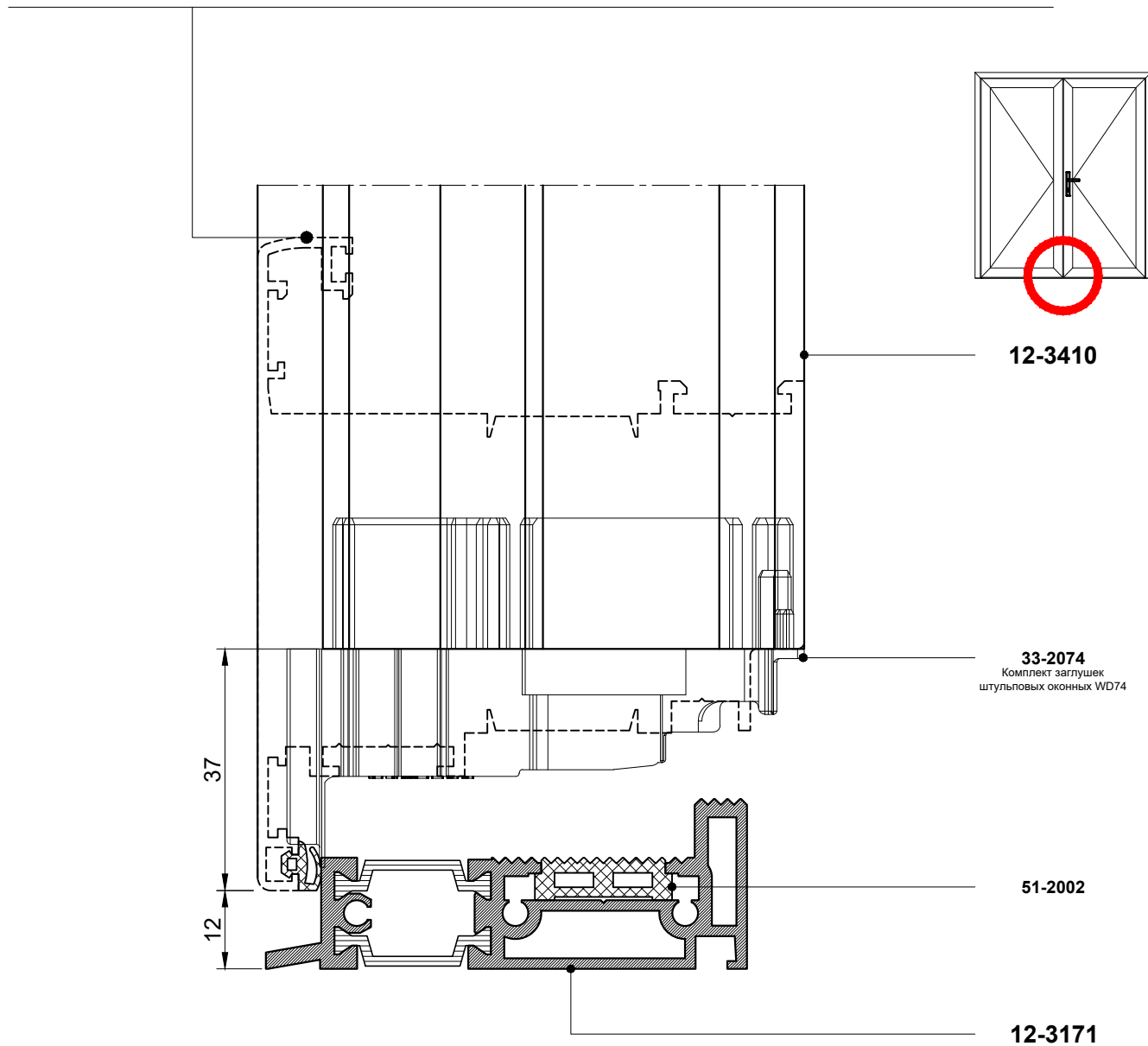
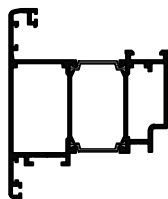

12-3332

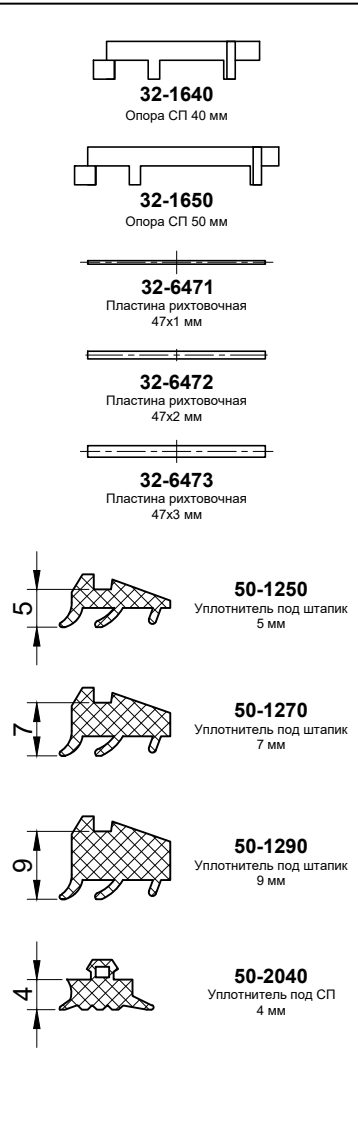
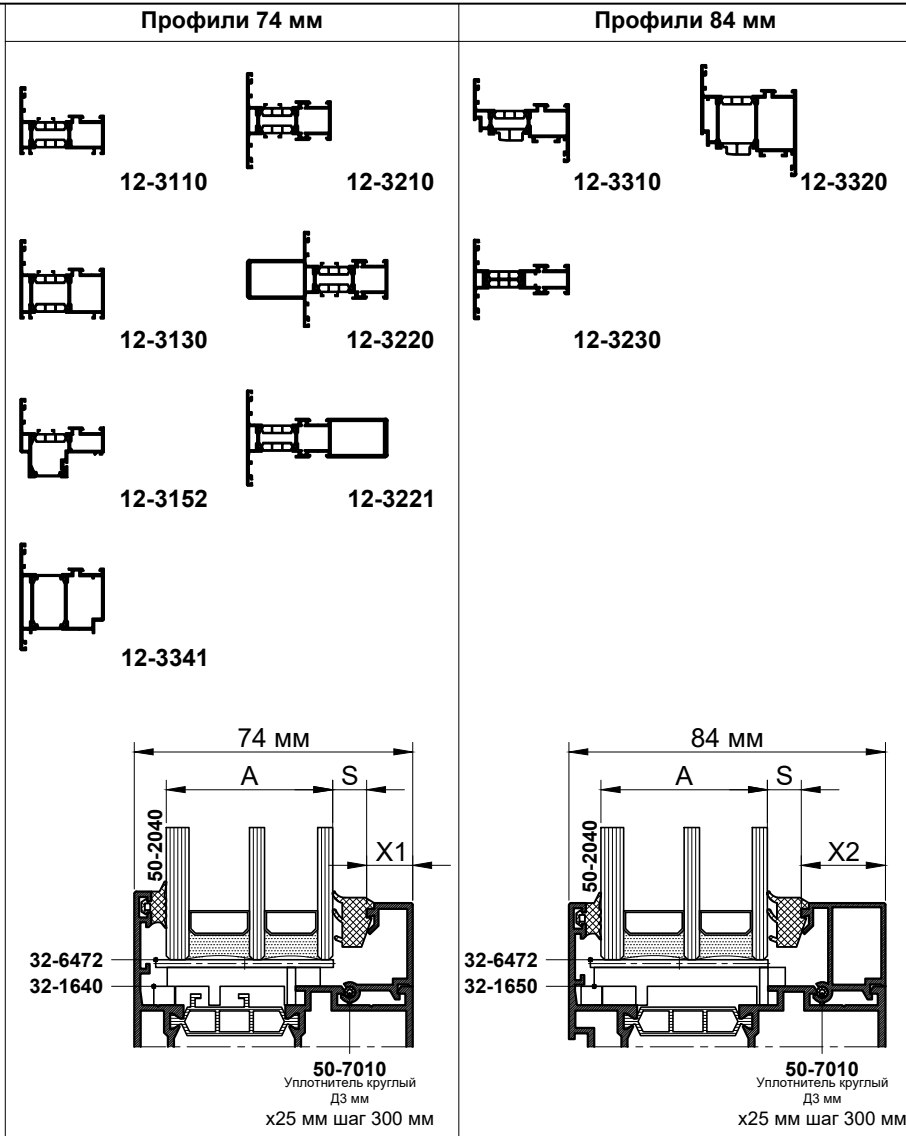

Толщина заполнения, А мм	Профили 74 мм		Профили 84 мм		Уплотнитель	
	Артикул	X1, мм	Артикул	X2, мм	Артикул	S, мм
	14					
16						
18						
20					50-1290	9
22	10-3360	36,5	10-3460	46,5	50-1270	7
24					50-1250	5
26					50-1270	7
28	10-3320	32,5	10-3420	42,5	50-1250	5
30					50-1290	9
32	10-3260	26,5	10-3360	36,5	50-1270	7
34					50-1250	5
36					50-1270	7
38	10-3220	22,5	10-3320	32,5	50-1250	5
40					50-1290	9
42	10-3160	16,5	10-3260	26,5	50-1270	7
44					50-1250	5
46					50-1270	7
48	10-3120	12,5	10-3220	22,5	50-1250	5

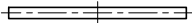
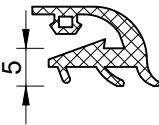
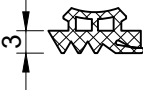
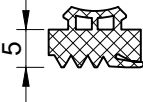

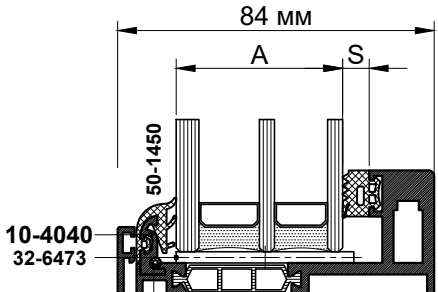
Профили створки скрытой						
 12-3360				 32-6473 Пластина рихтовочная 47x3 мм		
 50-1450 Уплотнитель под штапик 5 мм створки скрытой				 50-5030 Уплотнитель внутренний 3 мм		
 50-5050 Уплотнитель внутренний 5 мм				 50-5070 Уплотнитель внутренний 7 мм		
 84 мм A S 50-1450 10-4040 32-6473 50-7010 Уплотнитель круглый Д3 мм На всю длину						
Толщина заполнения, А мм	Штапик				Уплотнитель	
	Артикул				Артикул	S, мм
44	10-4040				50-5070	7
46					50-5050	5
48					50-5030	3



Толщина заполнения, А мм	Профили 74 мм, крыло 44 мм		Профили 74 мм, крыло 22 мм		Уплотнитель	
	Артикул	X1, мм	Артикул	X1, мм	Артикул	S, мм
	44	10-3121	12,5	10-3120	12,5	50-1290
46	50-1270					7
48	50-1250					5

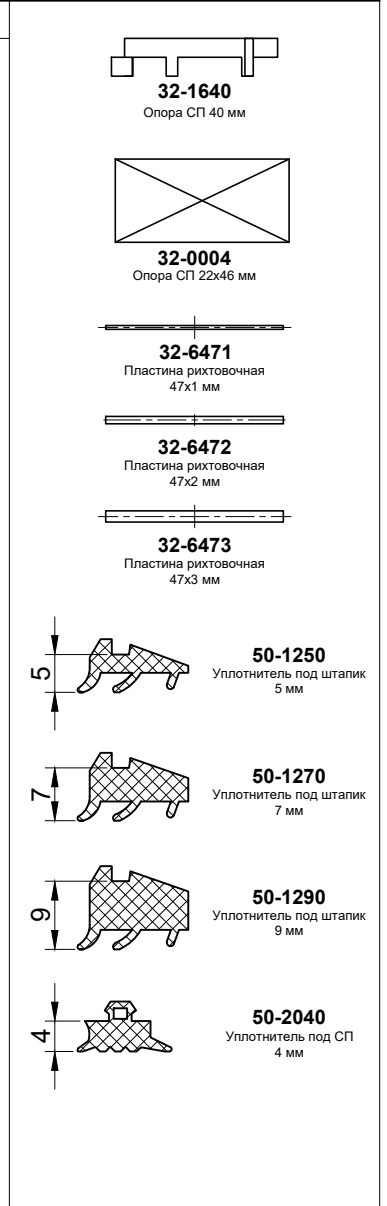
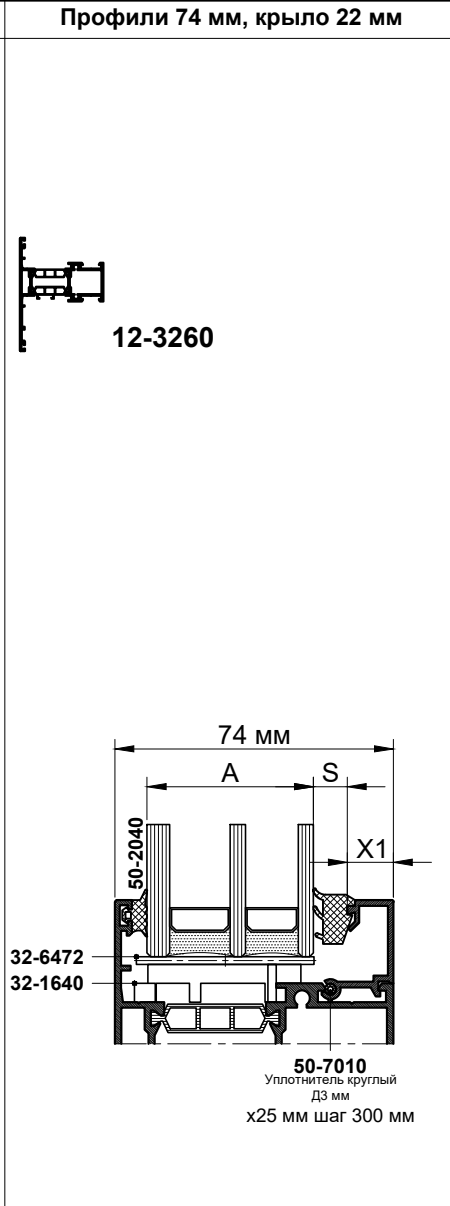
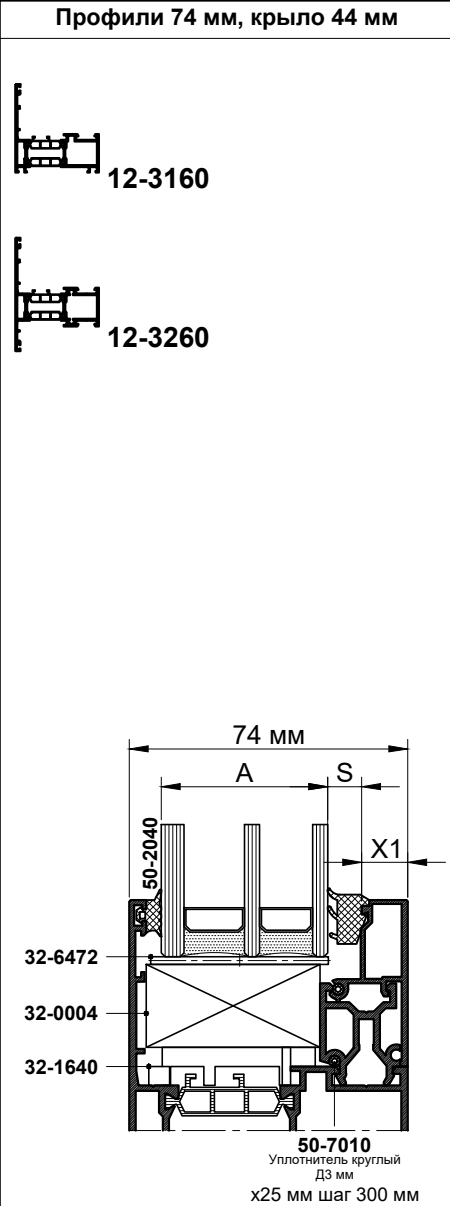

№ Комплекта	Схема изделия	Артикул	№ Комплекта	Схема изделия	Артикул
1		12-3110 12-3130 12-3152 12-3210 12-3220 12-3221	2		12-3310 12-3320
3		12-3310 12-3320 12-3332	4		12-3310 12-3320
5		12-3310 12-3320 12-3332	6		12-3310 12-3320
7		12-3341			

№ Комплекта	Опора стеклопакета		Пластина рихтовочная		
	32-1640 Опора СП 40 мм	32-1650 Опора СП 50 мм	32-6471 Пластина рихтовочная 47x1 мм	32-6472 Пластина рихтовочная 47x2 мм	32-6473 Пластина рихтовочная 47x3 мм
1	x2		x1	x2	
2		x4	x1	x4	x1
3		x4	x1	x4	x1
4		x8	x2	x8	x2
5		x6	x2	x6	x2
6		x10	x3	x10	x2
7	x6		x2	x6	x2



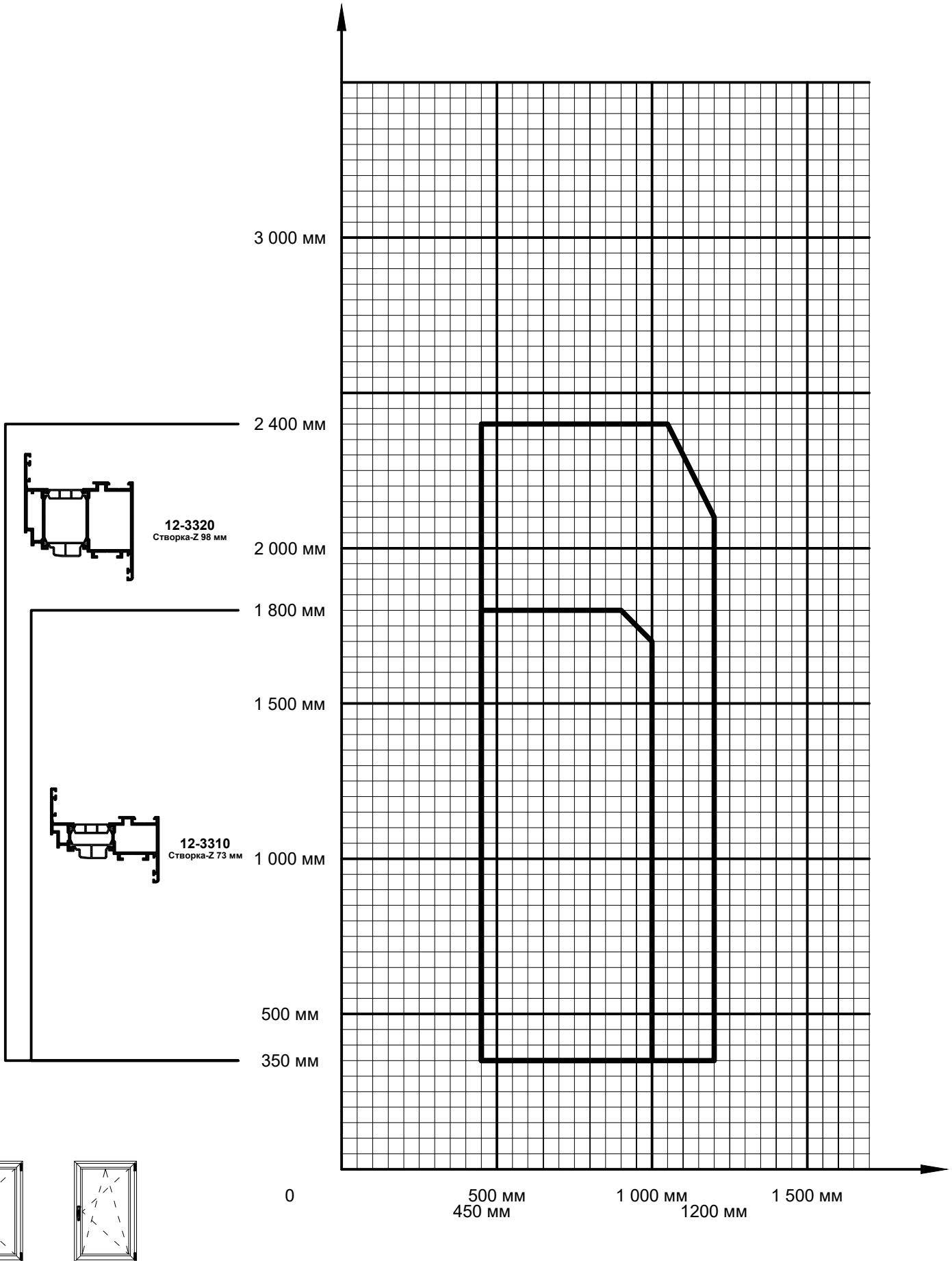

$h \leq 1200$

$1200 < h \leq 2400$

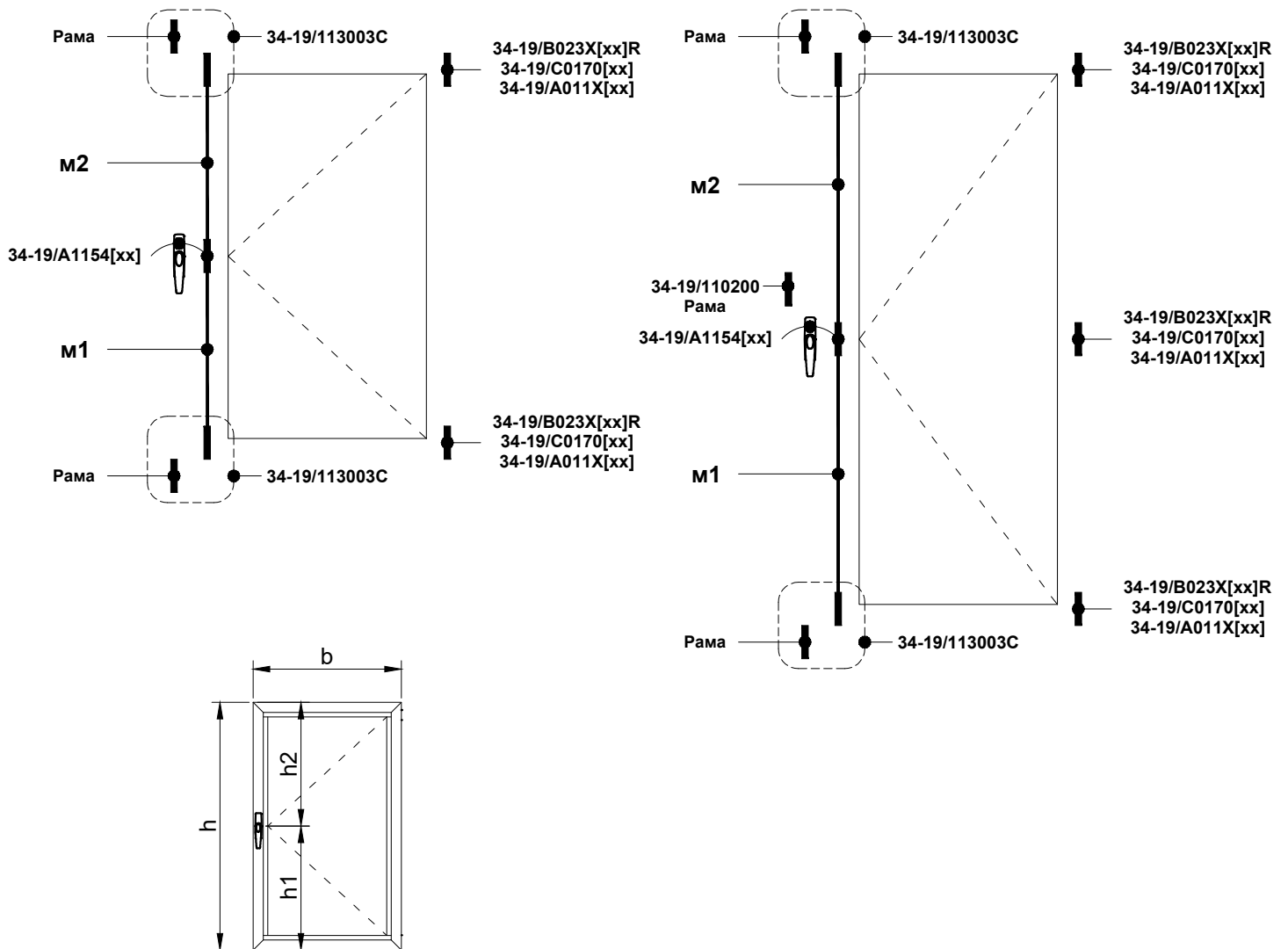

Мувиль	Длина, мм
м1	h1 - 82
м2	h2 - 190

Вес створки, кг	Навес	Ручка	Запорная часть		Ограничения	
			$h \leq 1200$	$1200 < h \leq 2400$	Ширина	Высота
≤ 50	34-19/B023X[xx]R	34-19/A1154[xx]	34-19/113003C x2	34-19/113003C x2 34-19/110200	см. диаграмму	
≤ 60	34-19/C0170[xx]					
≤ 90	34-19/A011X[xx]					



$h \leq 1200$

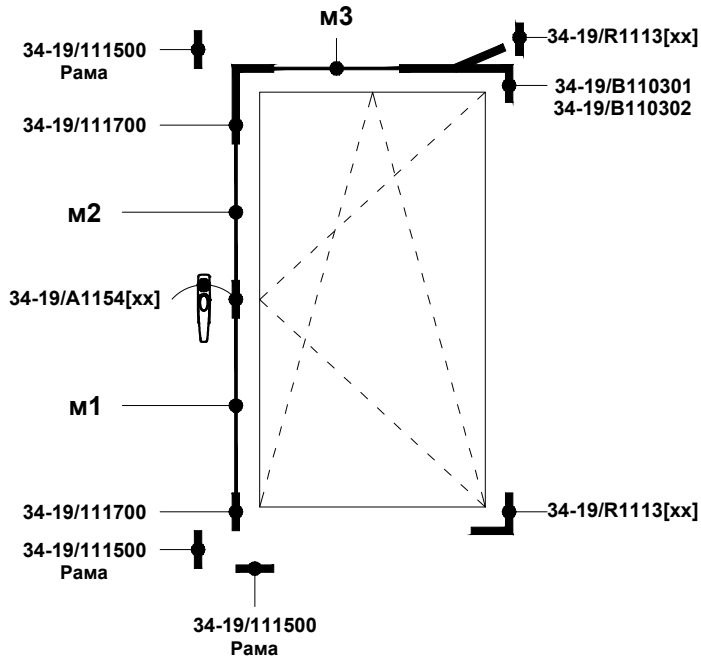

$1200 < h \leq 2400$

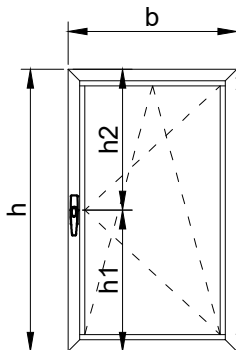
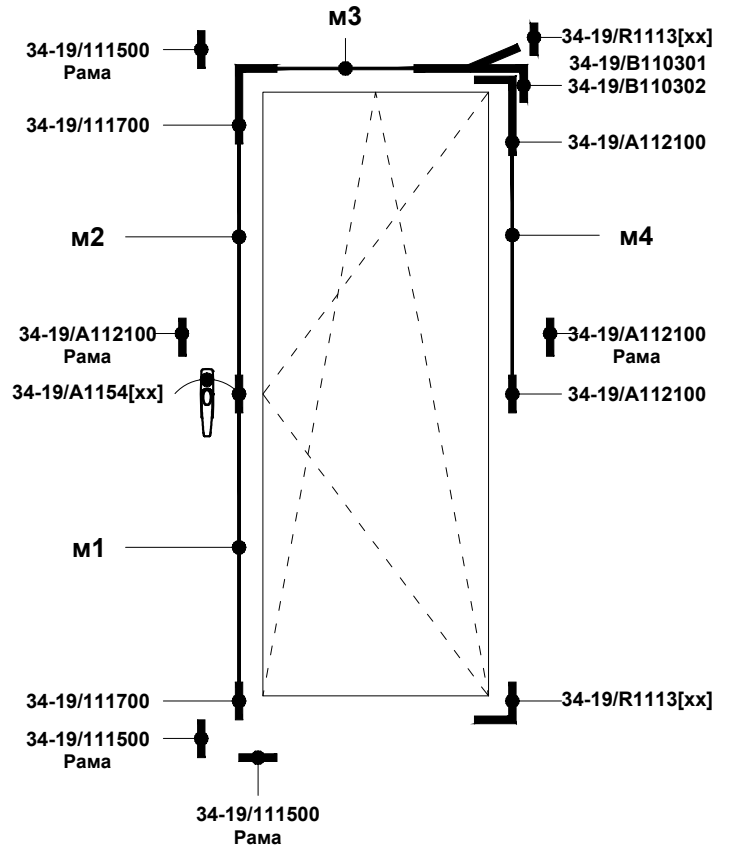

Мувиљ	Артикул	Длина, мм
м1		h1 - 82
м2		h2 - 190
м3	34-19/B110301	b - 495
	34-19/B110302	b - 373
м4		h/2 - 205

Высота (h), мм	Ширина (b), мм		Ручка
	450 ≤ b ≤ 750	750 < b ≤ 1200	
h ≤ 1200	34-19/B110302 x1 34-19/111700 x1 34-19/111500 x1 34-19/R1113[xx] x1	34-19/B110301 x1 34-19/111700 x1 34-19/111500 x1 34-19/R1113[xx] x1	34-19/A1154[xx]
1200 < h ≤ 2400	34-19/B110302 x1 34-19/111700 x1 34-19/111500 x1 34-19/R1113[xx] x1 34-19/A112100 x1	34-19/B110301 x1 34-19/111700 x1 34-19/111500 x1 34-19/R1113[xx] x1 34-19/A112100 x1	



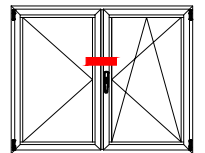
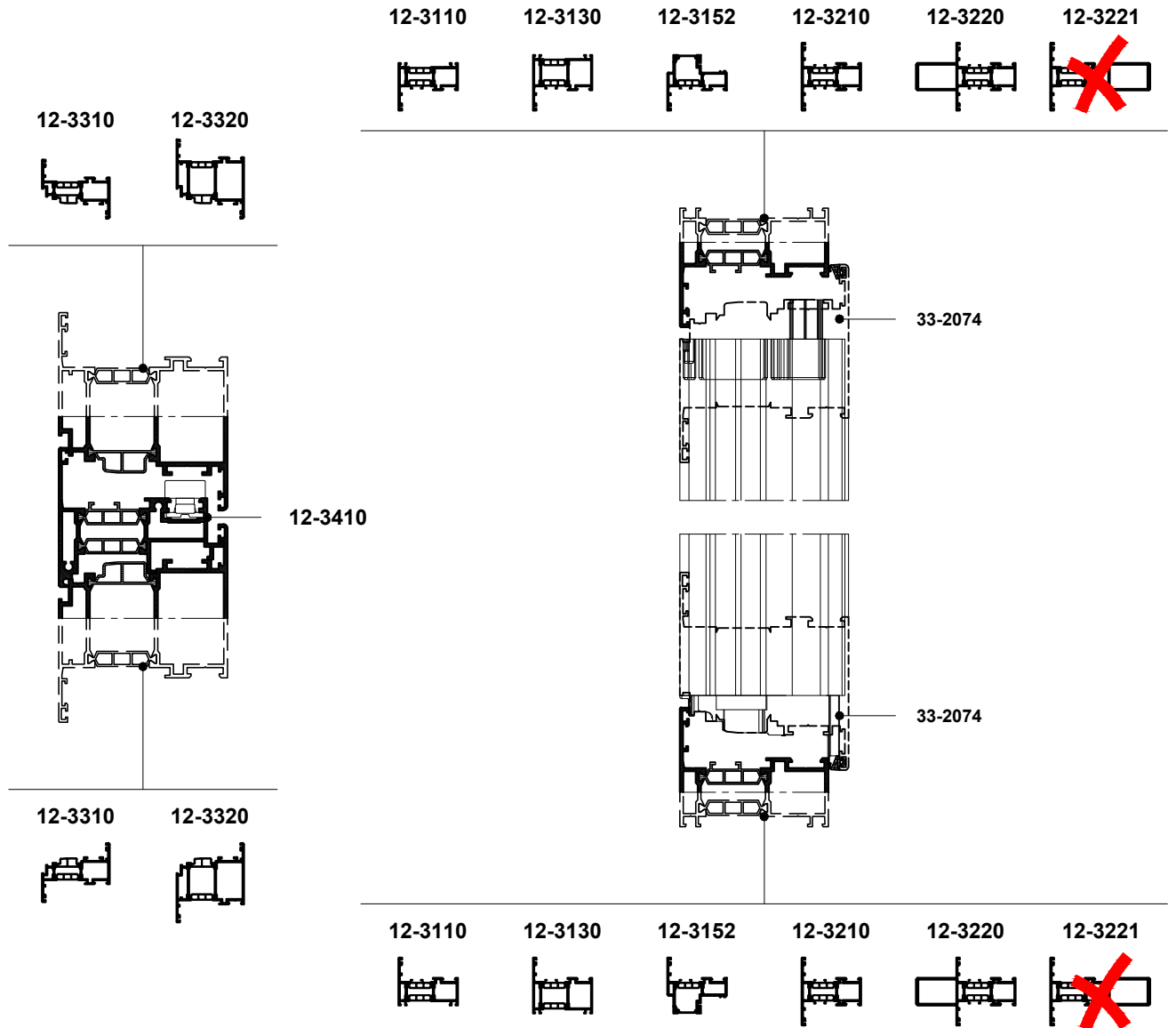

Шпингалет				Планка ответная			Примыкающий элемент
Внешний вид	Артикул	Наименование	Крепление	Внешний вид	Артикул	Крепление	Артикул
	34-19/111601	Комплект шпингалетов шульповых	В комплекте			В комплекте	12-3110 12-3130 12-3152 12-3210 12-3220



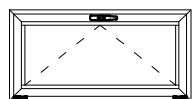
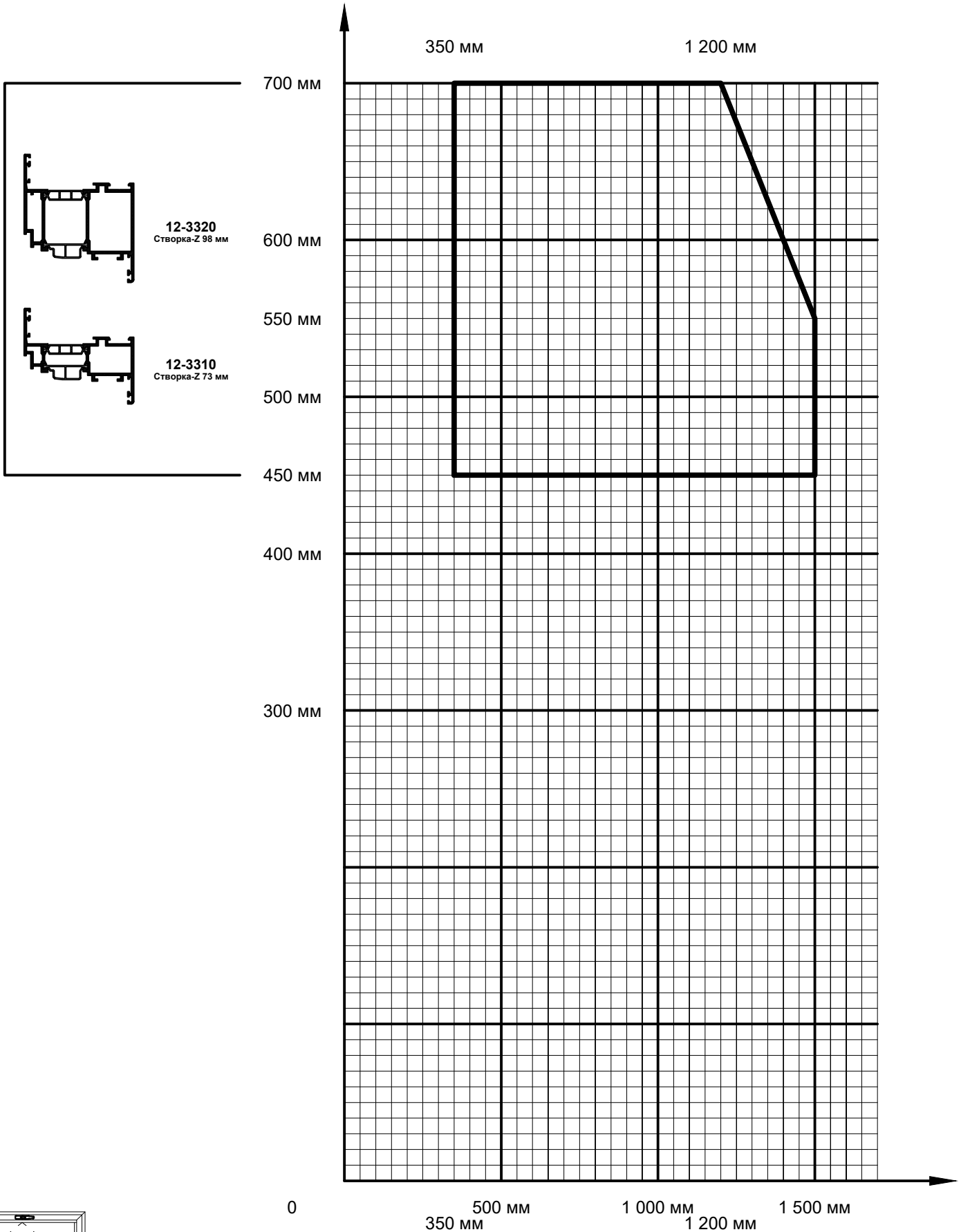

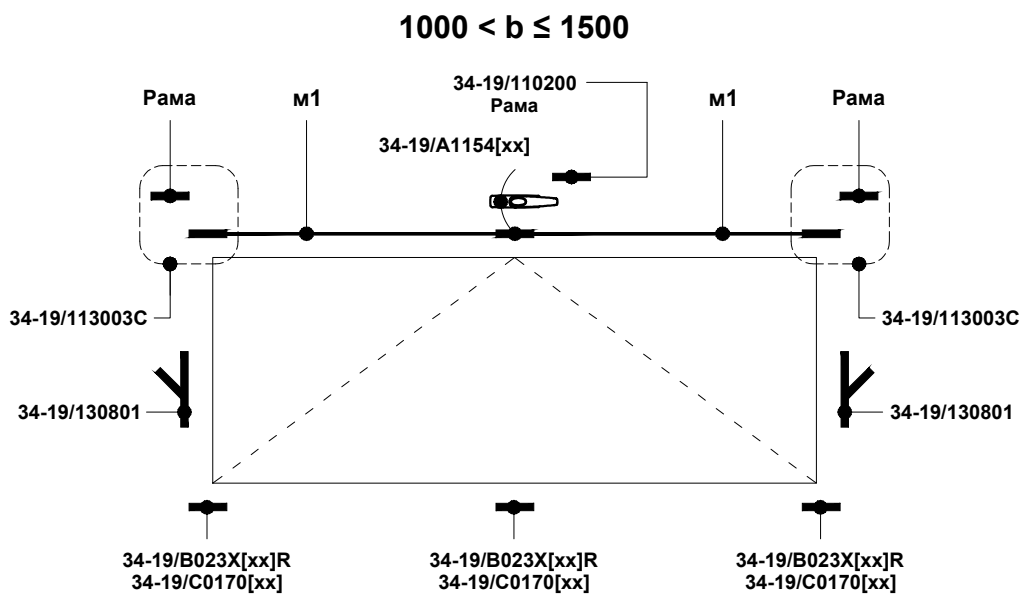
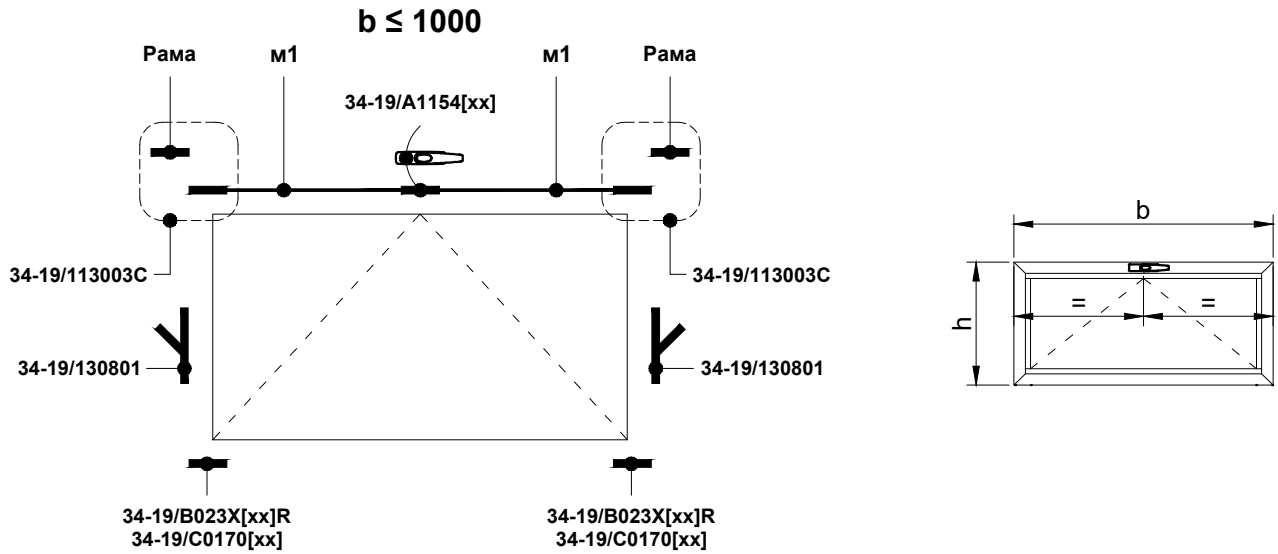

Мувиль	Длина, мм
м1	$h/2 - 205$

Вес створки, кг	Навес	Ограничитель открывания	Ручка	Запорная часть		Ограничения	
				$b \leq 1000$	$1000 < b \leq 1500$	Ширина	Высота
≤ 15	34-19/B023X[xx]R	34-19/130801 x2	34-19/A1154[xx]	34-19/113003C x2	34-19/113003C x2	см. диаграмму	
≤ 30	34-19/C0170[xx]						



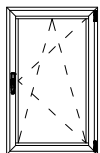
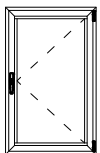
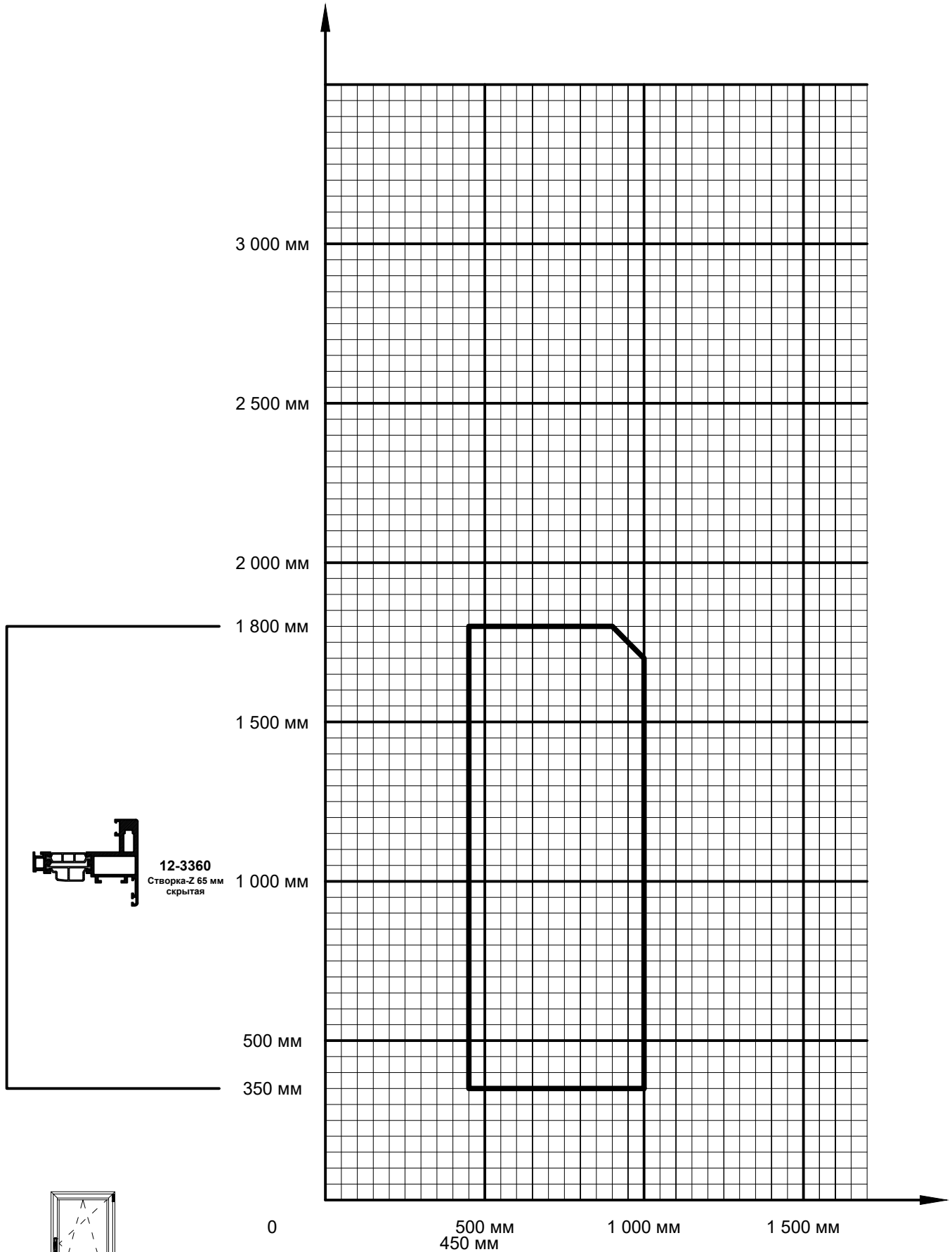

$h \leq 1200$

$1200 < h \leq 1800$

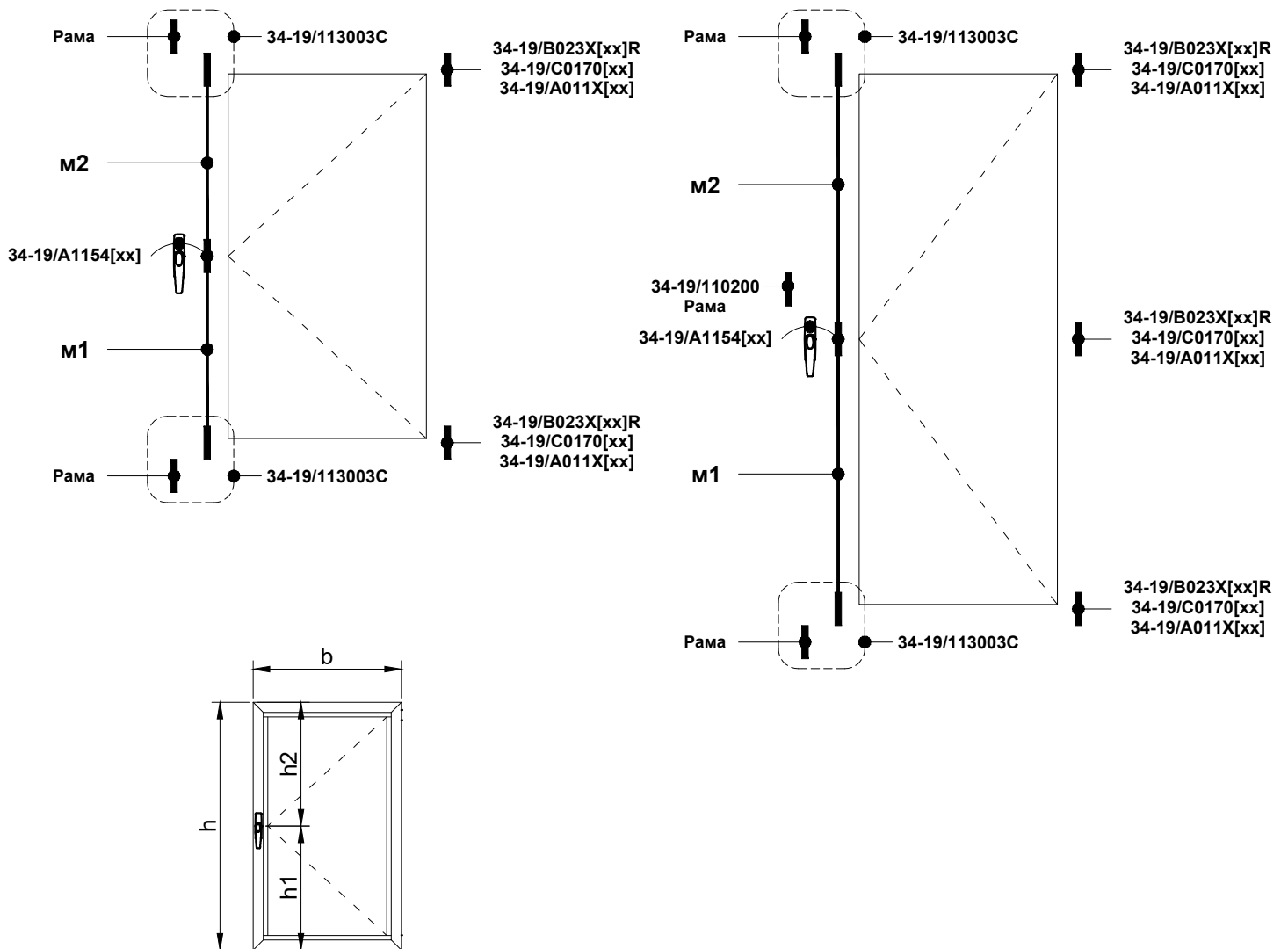

Мувиль	Длина, мм
м1	h1 - 82
м2	h2 - 190

Вес створки, кг	Навес	Ручка	Запорная часть		Ограничения	
			$h \leq 1200$	$1200 < h \leq 1800$	Ширина	Высота
≤ 50	34-19/B023X[xx]R	34-19/A1154[xx]	34-19/113003C x2	34-19/113003C x2 34-19/110200	см. диаграмму	
≤ 60	34-19/C0170[xx]					
≤ 90	34-19/A011X[xx]					



$h \leq 1200$

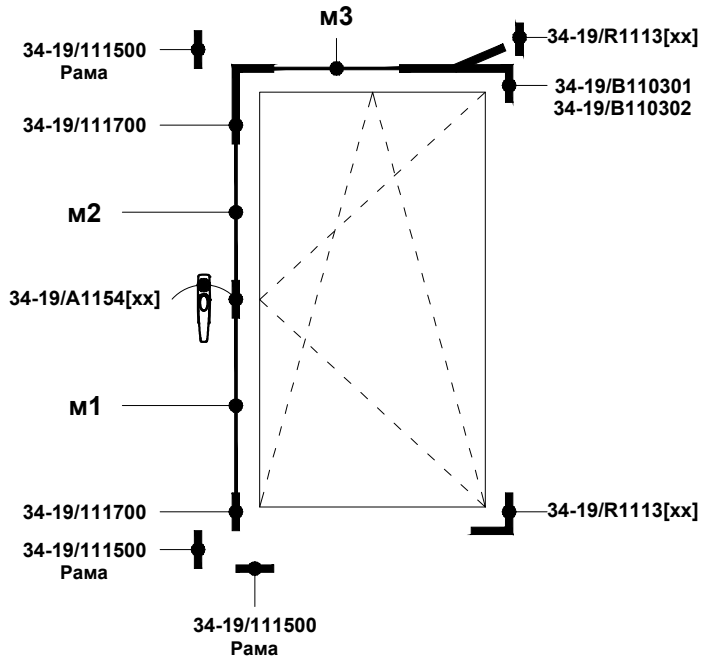

$1200 < h \leq 1800$

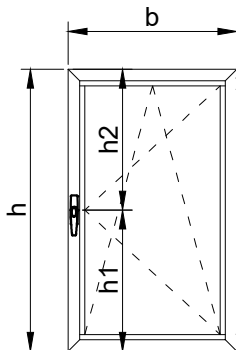
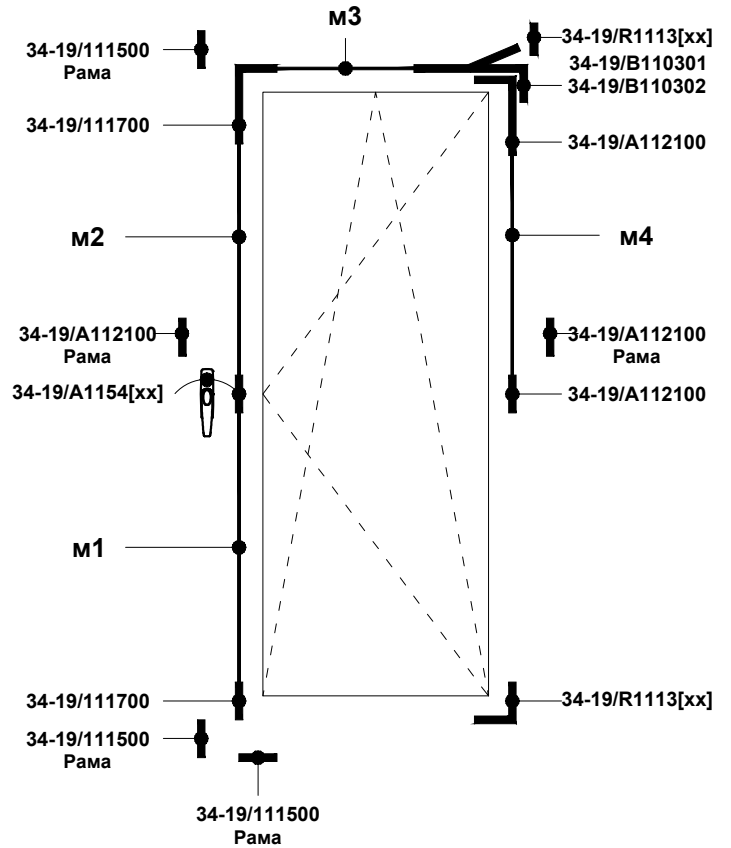

Мувиљ	Артикул	Длина, мм
м1		h1 - 82
м2		h2 - 190
м3	34-19/B110301	b - 495
	34-19/B110302	b - 373
м4		h/2 - 205

Высота (h), мм	Ширина (b), мм		Ручка
	450 ≤ b ≤ 750	750 < b ≤ 1000	
h ≤ 1200	34-19/B110302 x1 34-19/111700 x1 34-19/111500 x1 34-19/R1113[xx] x1	34-19/B110301 x1 34-19/111700 x1 34-19/111500 x1 34-19/R1113[xx] x1	34-19/A1154[xx]
1200 < h ≤ 2400	34-19/B110302 x1 34-19/111700 x1 34-19/111500 x1 34-19/R1113[xx] x1 34-19/A112100 x1	34-19/B110301 x1 34-19/111700 x1 34-19/111500 x1 34-19/R1113[xx] x1 34-19/A112100 x1	



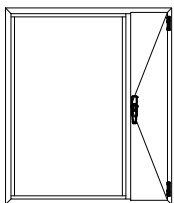
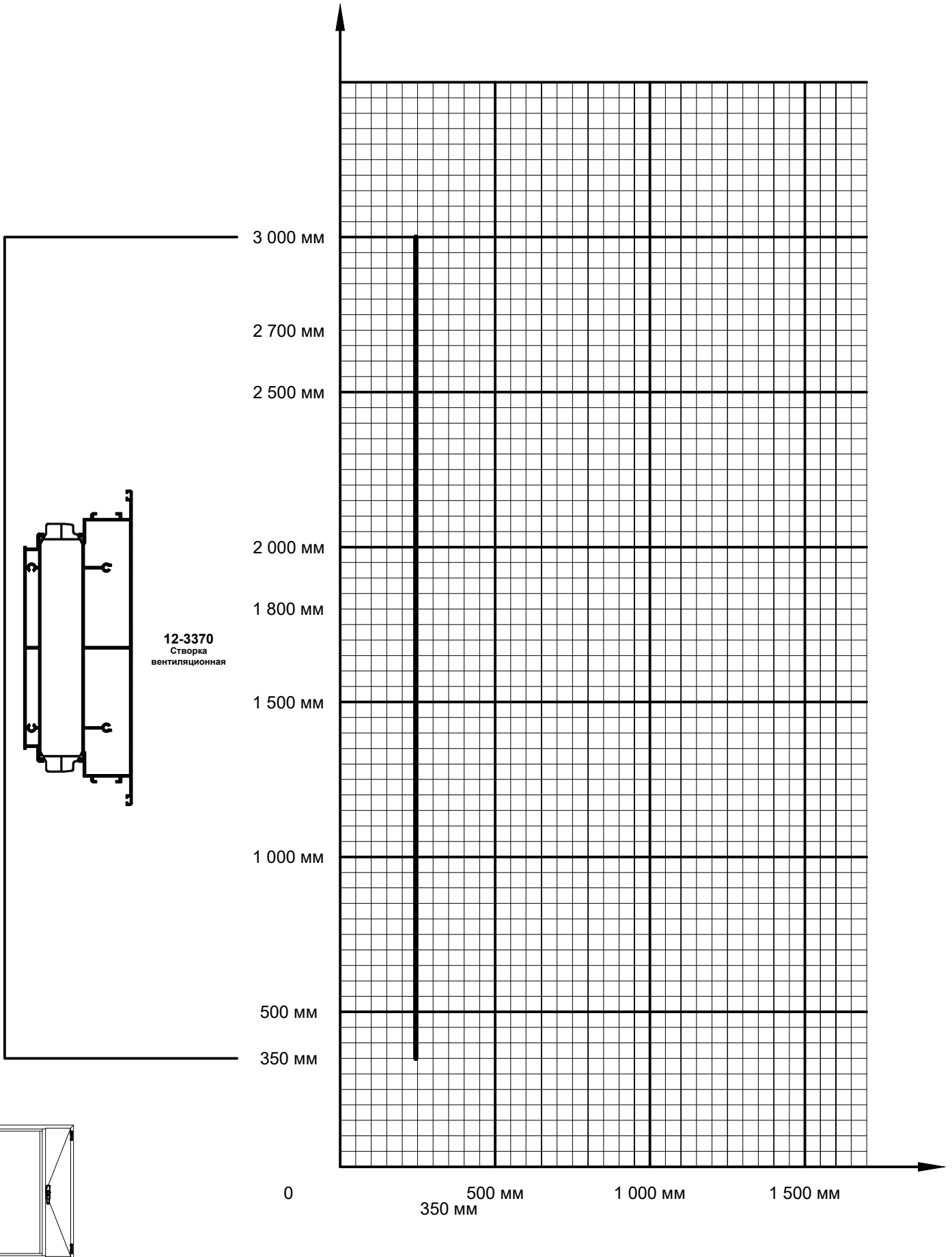

$h \leq 1200$

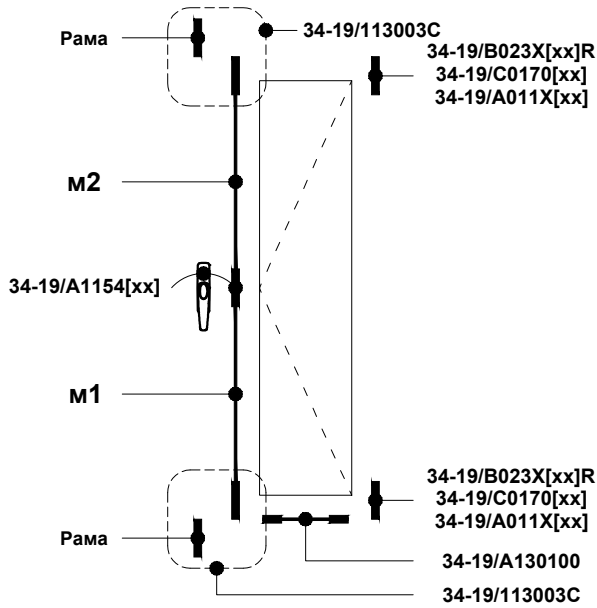

$2400 < h \leq 3000$

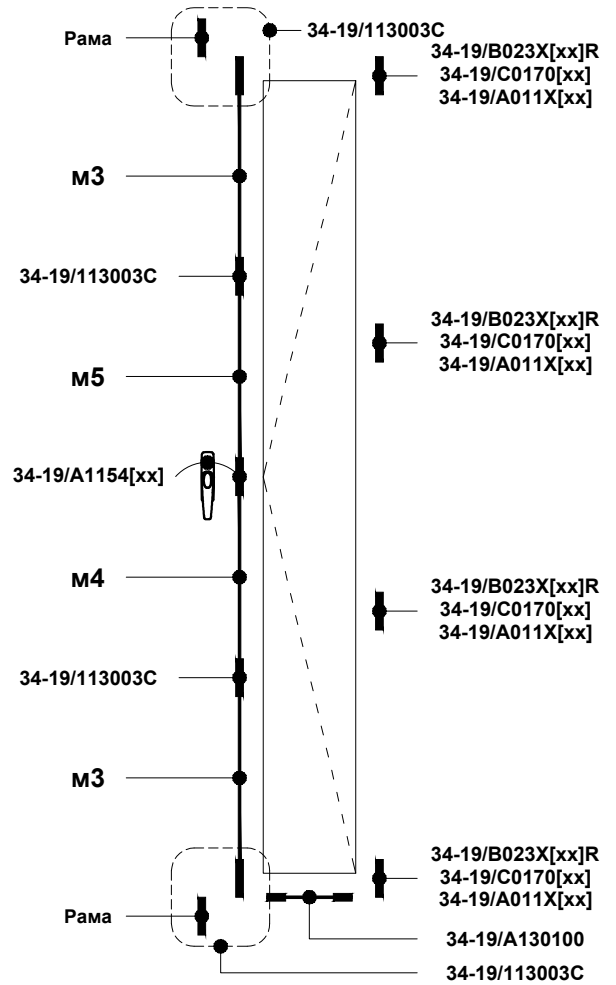

$1200 < h \leq 2400$

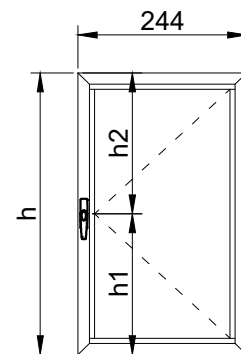
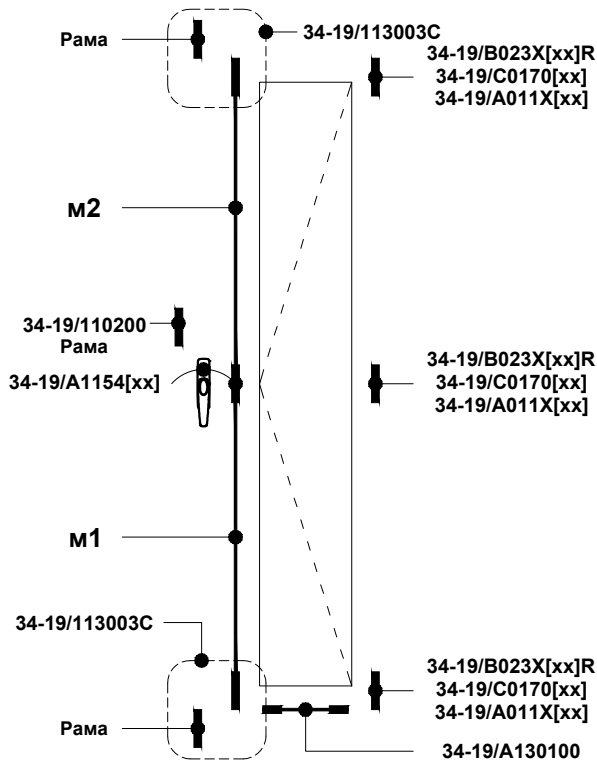

Мувиль	Длина, мм
м1	h1 - 82
м2	h2 - 190

Мувиль	Длина, мм
м3	700
м4	h1 - 842
м5	h2 - 950

Вес створки кг	Навес	Ручка	Ограничитель	Запорная часть			Ограничения	
				$h \leq 1200$	$1200 < h \leq 2400$	$2400 < h \leq 3000$	Ширина	Высота
≤ 50	34-19/B023X[xx]R	34-19/A1154[xx]	34-19/A130100	34-19/113003C x2	34-19/113003C x2 34-19/110200	34-19/113003C x4	см. диаграмму	
≤ 60	34-19/C0170[xx]							
≤ 90	34-19/A011X[xx]							



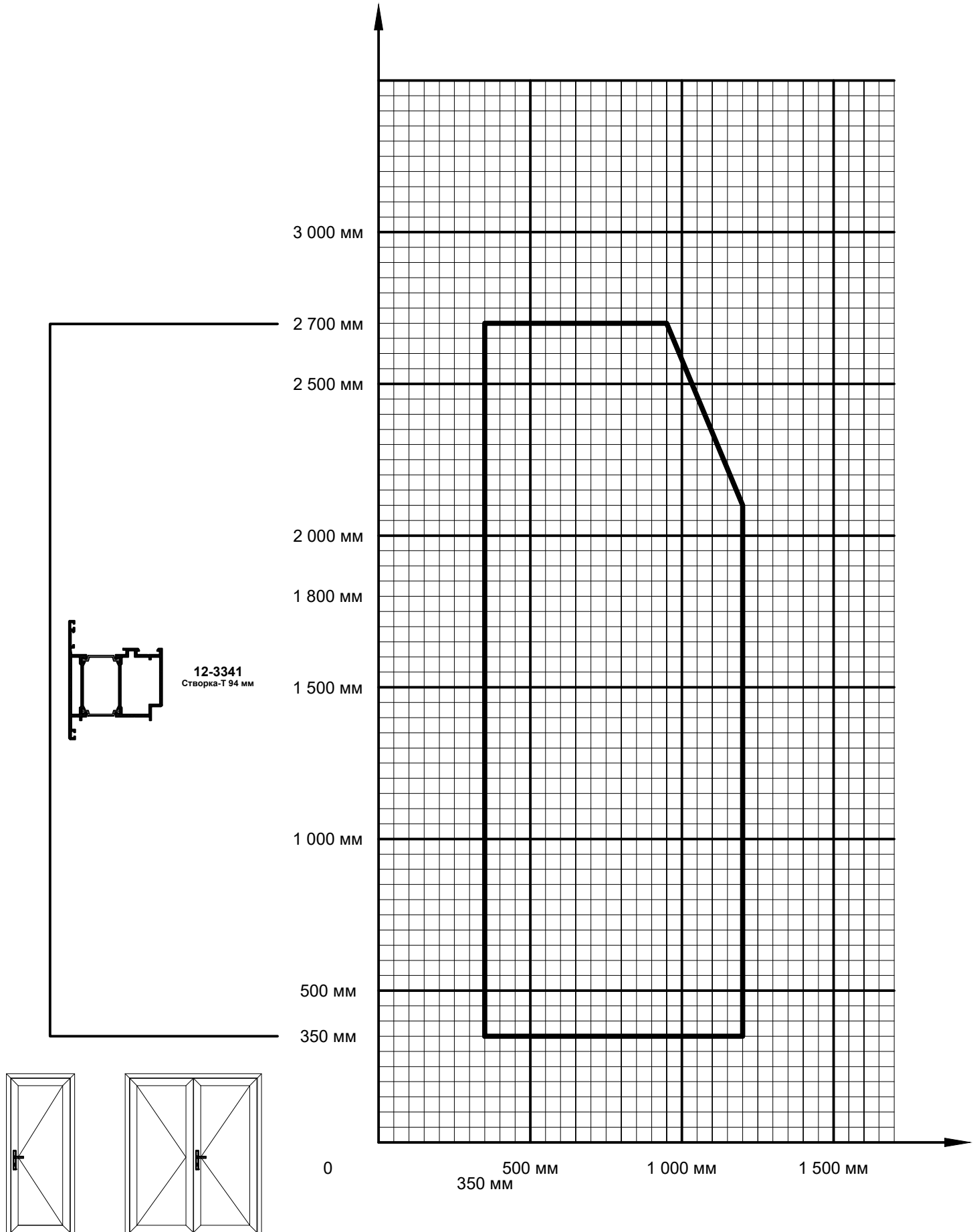

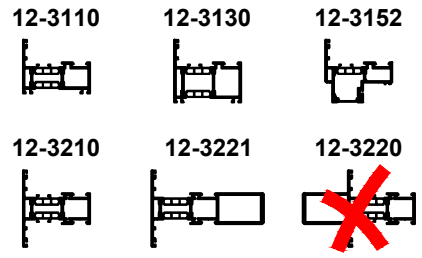
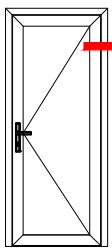
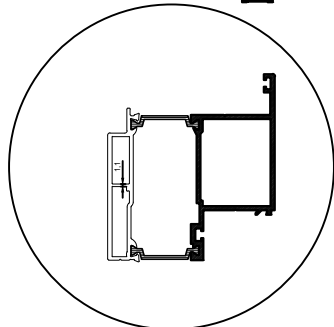
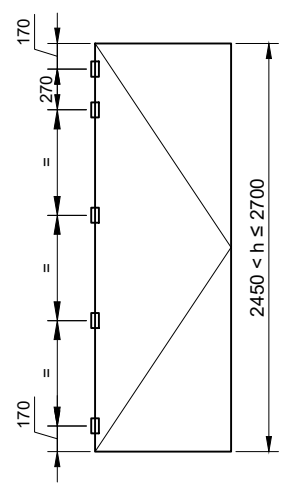
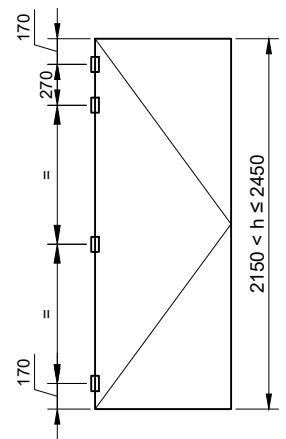
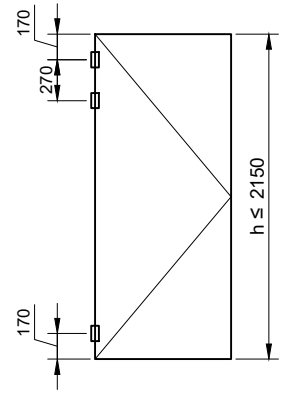
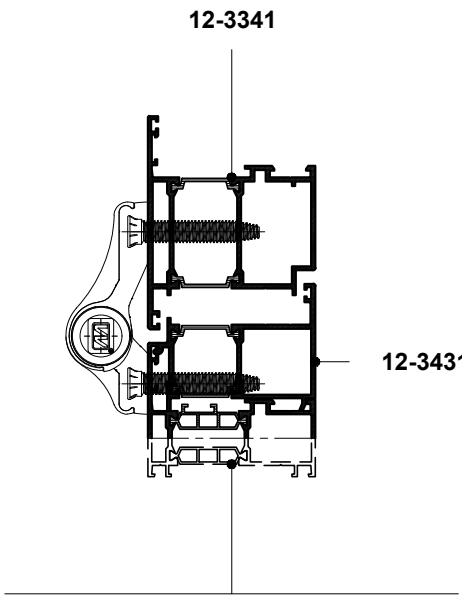
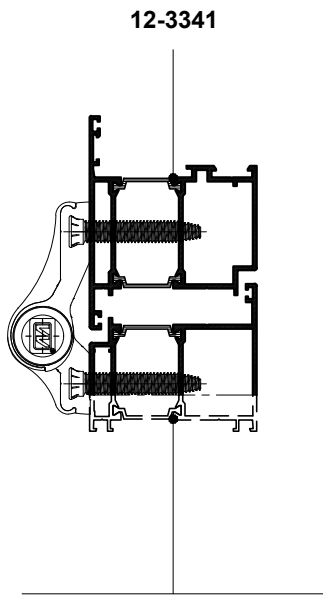

Навес			Крепление		
Внешний вид	Артикул	Наименование	Внешний вид	Артикул	Наименование
	34-25/M701<x>E000	Навес дверной Dr. Hahn		34-25/VP02A0000	Комплект крепления для навеса Dr. Hahn
	34-20/WX8010456[x]	Навес двухчастный WLINE-WX	x4	34-20/WX80SD4980	Крепление для навеса WALA
	34-20/MX8010456[x]	Навес двухчастный WLINE-MX	x4	34-20/WX80SD4980	Крепление для навеса WALA



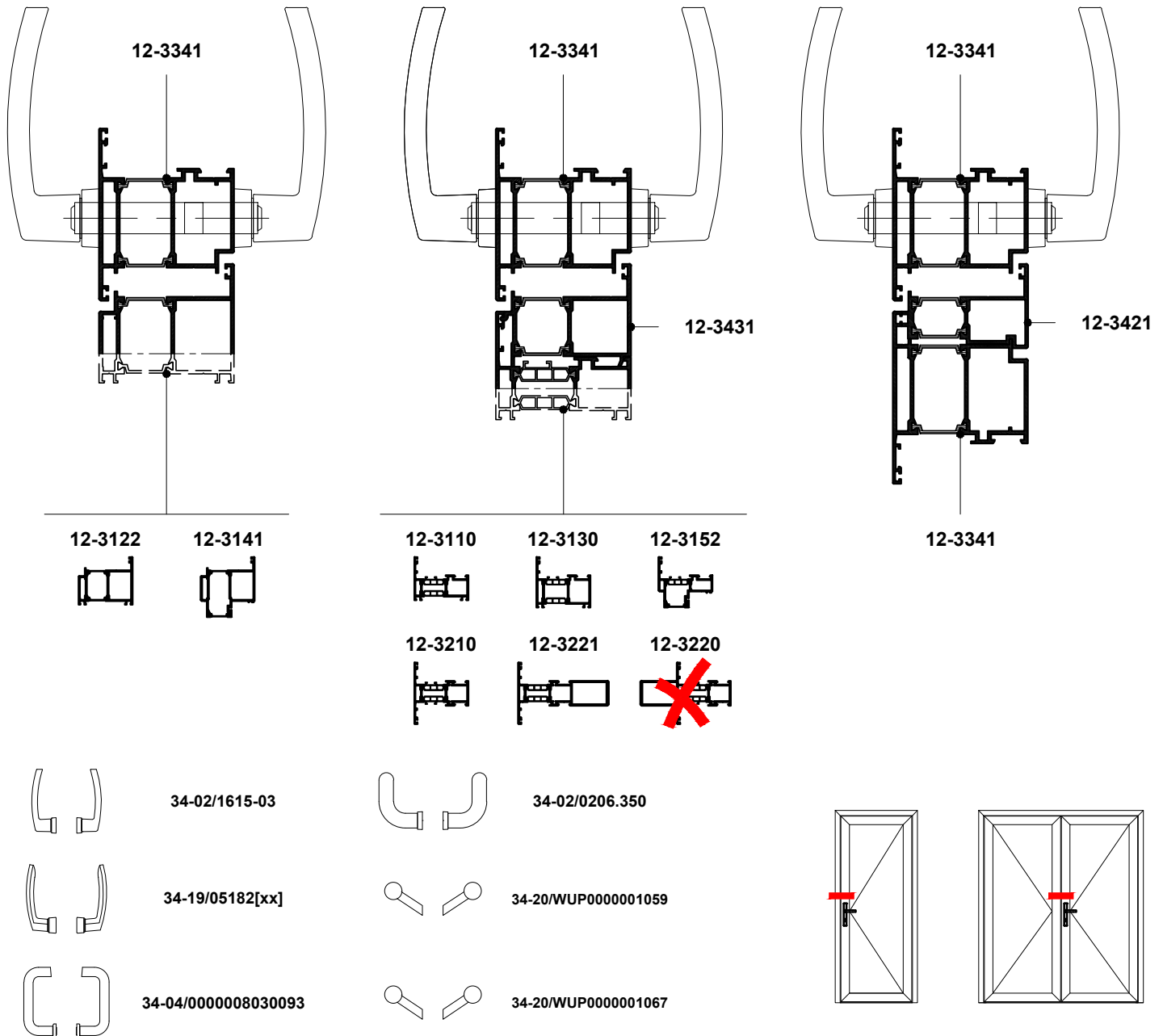

Ручка				Накладка			Цилиндр фигурный
Внешний вид	Артикул	Наименование	Крепление	Внешний вид	Артикул	Крепление	Артикул
	34-02/1615-03	Гарнитура нажимной 32/92/66-75	46-DIN966 A2 M5x80 TX25 x3	-	-	-	34-01/0003/3565
	34-19/05182[xx]	Комплект ручек нажимных POLARIS	46-DIN965 Zn M5x16 TX25 x8 40-ART1021 A2 M5x11,5 x8		34-19/0508053[xx] x2	41-DIN7981C A2 3,9x13 TX15 x4	34-01/0003/3060
	34-04/0000008030093	Комплект ручек нажимных с накладками	В комплекте	В комплекте	В комплекте	В комплекте	34-01/0003/3060
	34-02/0206.350	Комплект ручек дверных стационарных	В комплекте		34-19/0508053[xx] x2	41-DIN7981C A2 3,9x13 TX15 x4	34-01/0003/3060
	34-20/WUP0000001059	Комплект ручек 1200-1400 мм с креплением	В комплекте		34-23/0000417611	43-DIN7982C A2 3,9x13 TX15 x4	34-01/0003/3565
	34-20/WUP0000001067	Комплект ручек 300-500 мм с креплением	В комплекте		34-23/0000417611	43-DIN7982C A2 3,9x13 TX15 x4	34-01/0003/3565



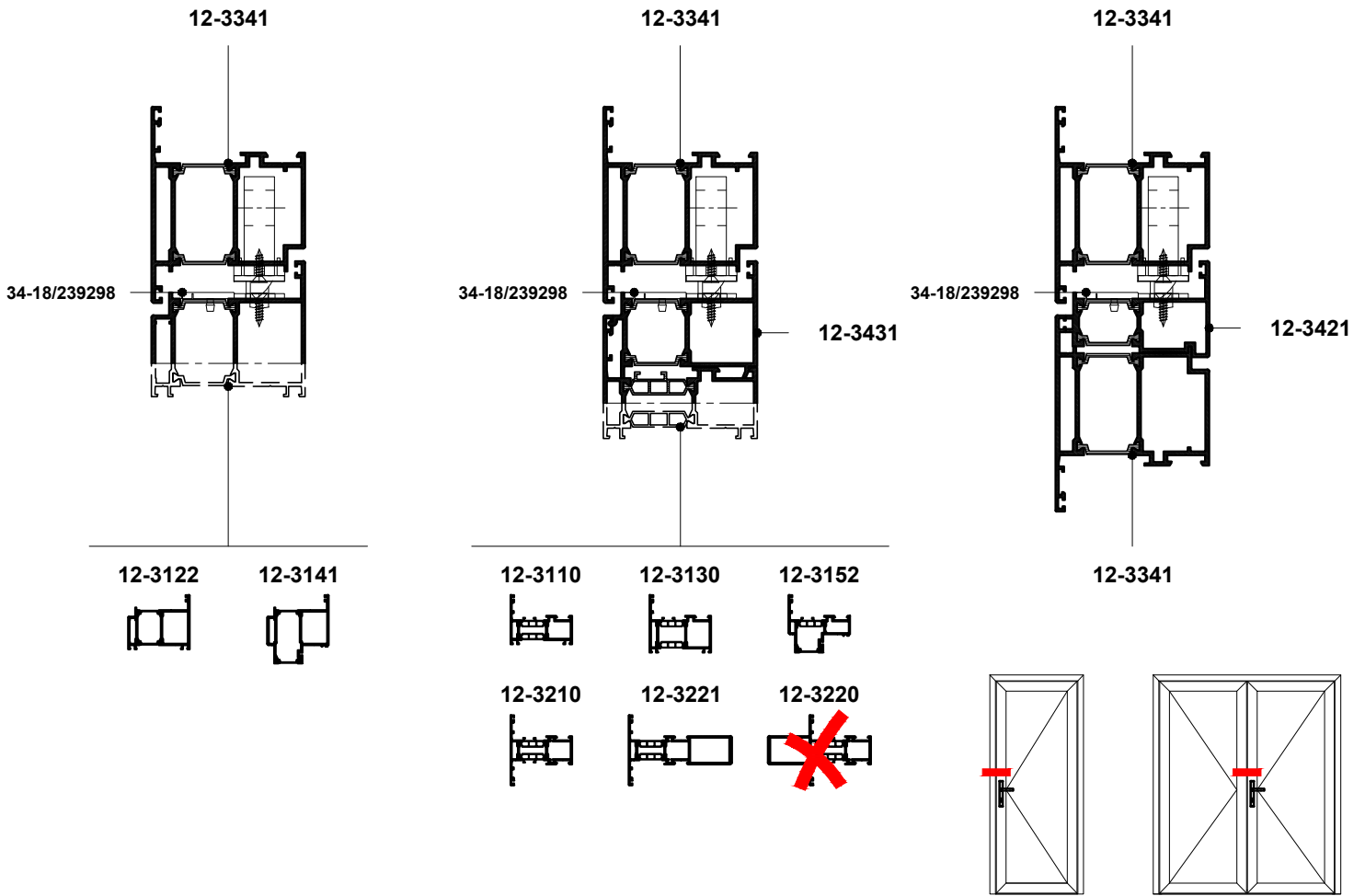



Ручка	Замок				Планка ответная		
	Внешний вид	Артикул	Наименование	Крепление	Внешний вид	Артикул	Крепление
Нажимные 34-02/1615-03 Гарнитура нажимной 32/92/66-75 34-19/05182[xx] Комплект ручек нажимных POLARIS 34-04/0000008030093 Комплект ручек нажимных с накладками		34-22/3469528	Замок клиновидный KFV RES 49N 24x6/92/35	43-DIN7982C A2 3,9x16 TX15 x2		34-22/3477532 лев 34-22/3477533 прав	34-18/239298 43-DIN7982C A2 3,9x16 TX15 x3
		34-04/1100000009810	Замок клиновидный 24x3/92/35	34-04/1100000009939 43-DIN7982C A2 3,9x16 TX15 x2	-	В комплекте	34-18/239298 43-DIN7982C A2 3,9x16 TX15 x3
		34-22/3488093	Замок M3K KFV AS2300 24x6x1880-2170/35/92	43-DIN7982C A2 3,9x16 TX15 x10		34-22/3478553 лев 34-22/3478552 прав	34-18/239298 43-DIN7982C A2 3,9x16 TX15 x10
		34-22/3492892	Замок M3K KFV AS2750 24x6x1880-2170/35/92	43-DIN7982C A2 3,9x16 TX15 x10		34-22/3478553 лев 34-22/3478552 прав	34-18/239298 43-DIN7982C A2 3,9x16 TX15 x10
Стационарные 34-02/0206.350 Комплект ручек дверных стационарных 34-20/WUP0000001059 Комплект ручек 1200-1400 мм с креплением 34-20/WUP0000001067 Комплект ручек 300-500 мм с креплением		34-22/3469528	Замок клиновидный KFV RES 49N 24x6/92/35	43-DIN7982C A2 3,9x16 TX15 x2		34-22/3477532 лев 34-22/3477533 прав 34-22/3493198	34-18/239298 43-DIN7982C A2 3,9x16 TX15 x3
		34-04/1100000009820	Замок роликовый 24x3/92/35	34-04/1100000009939 43-DIN7982C A2 3,9x16 TX15 x2	-	В комплекте	34-18/239298 43-DIN7982C A2 3,9x16 TX15 x3
		34-22/3488093	Замок M3K KFV AS2300 24x6x1880-2170/35/92	43-DIN7982C A2 3,9x16 TX15 x10		34-22/3478553 лев 34-22/3478552 прав 34-22/3493198	34-18/239298 43-DIN7982C A2 3,9x16 TX15 x10

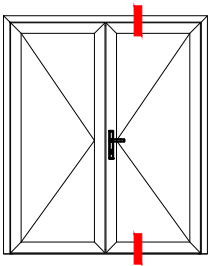
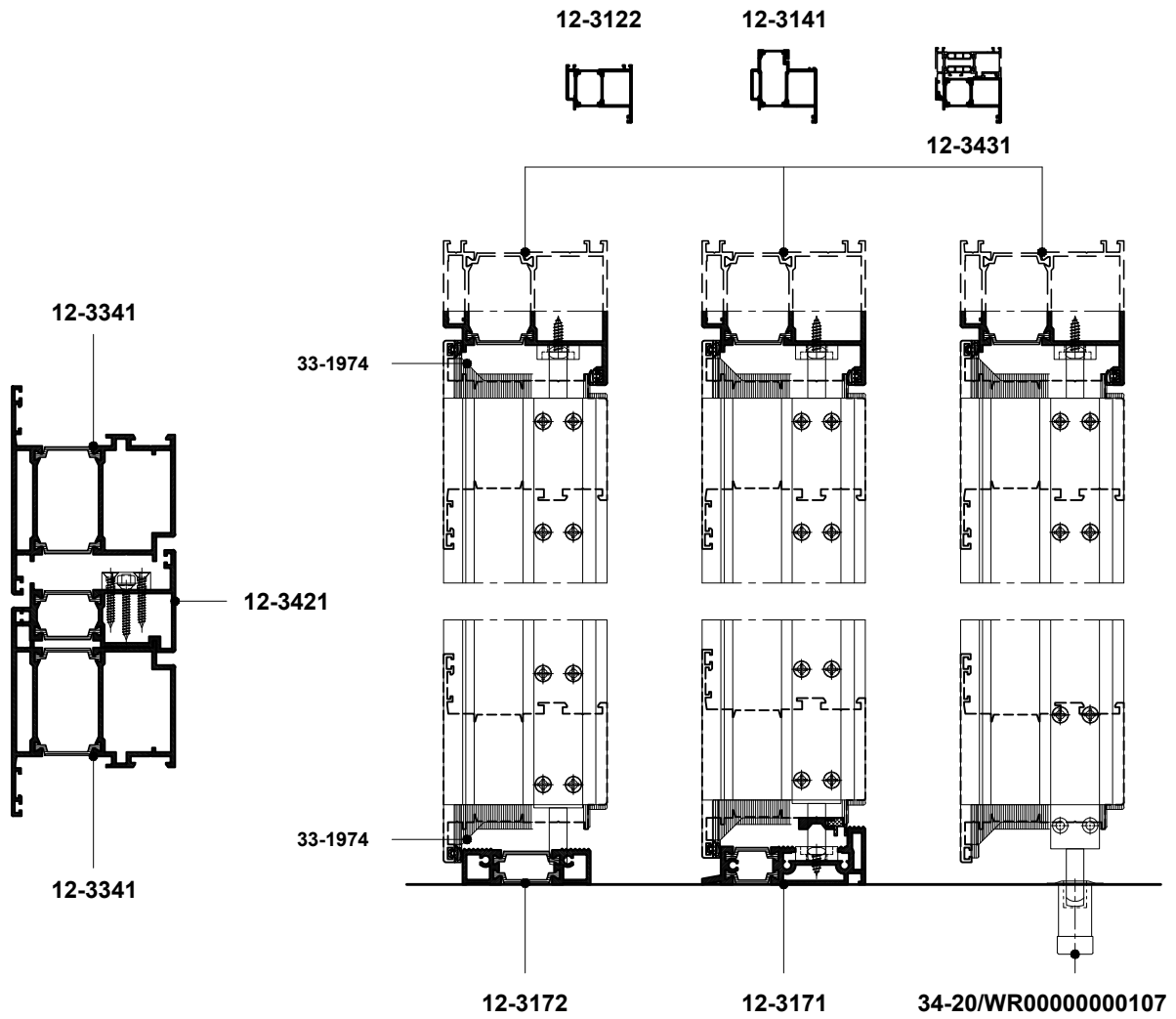

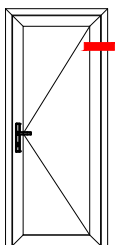
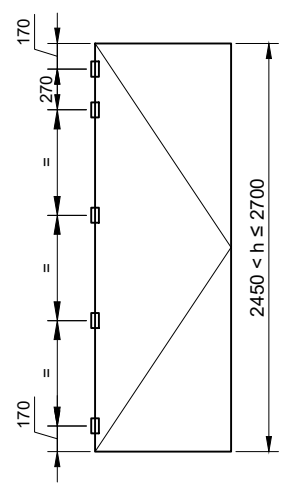
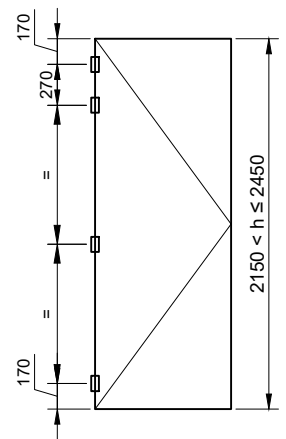
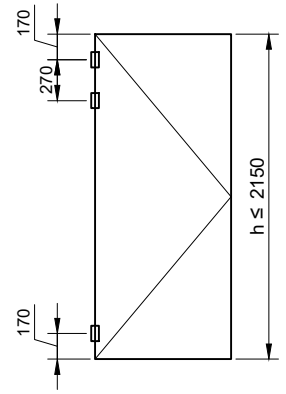
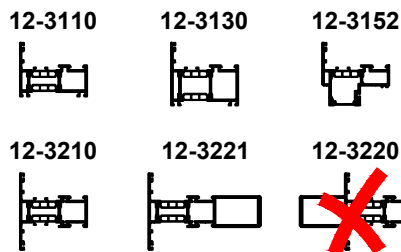
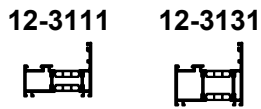
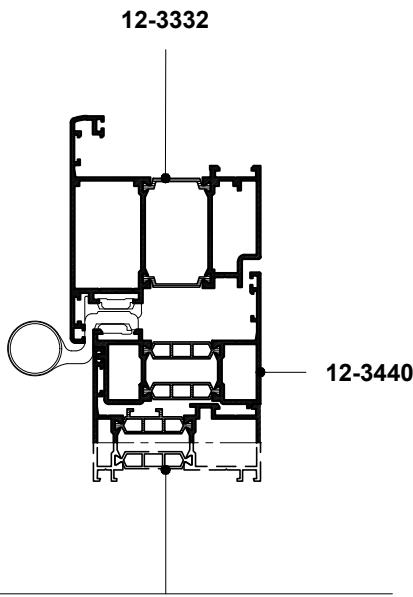
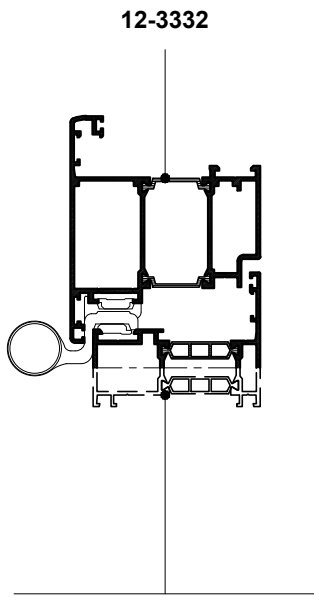

Шпингалет				Планка ответная			Примыкающий элемент
Внешний вид	Артикул	Наименование	Крепление	Внешний вид	Артикул	Крепление	Артикул
	34-21/8019005M2500H	Шпингалет 22x8x225	В комплекте		34-03/3012.20	В комплекте	12-3122 12-3141 12-3431 12-3171
	34-21/8019005M2500H	Шпингалет 22x8x225	В комплекте	-	-	-	12-3172
	34-21/8019005M2500H	Шпингалет 22x8x225	В комплекте		34-20/WR0000000107	-	Пол



Навес			Крепление
Внешний вид	Артикул	Наименование	
	34-19/A011X[xx]	Навес двухчастный TAURUS	В комплекте



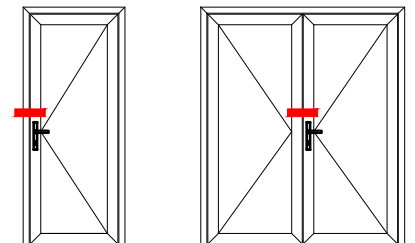
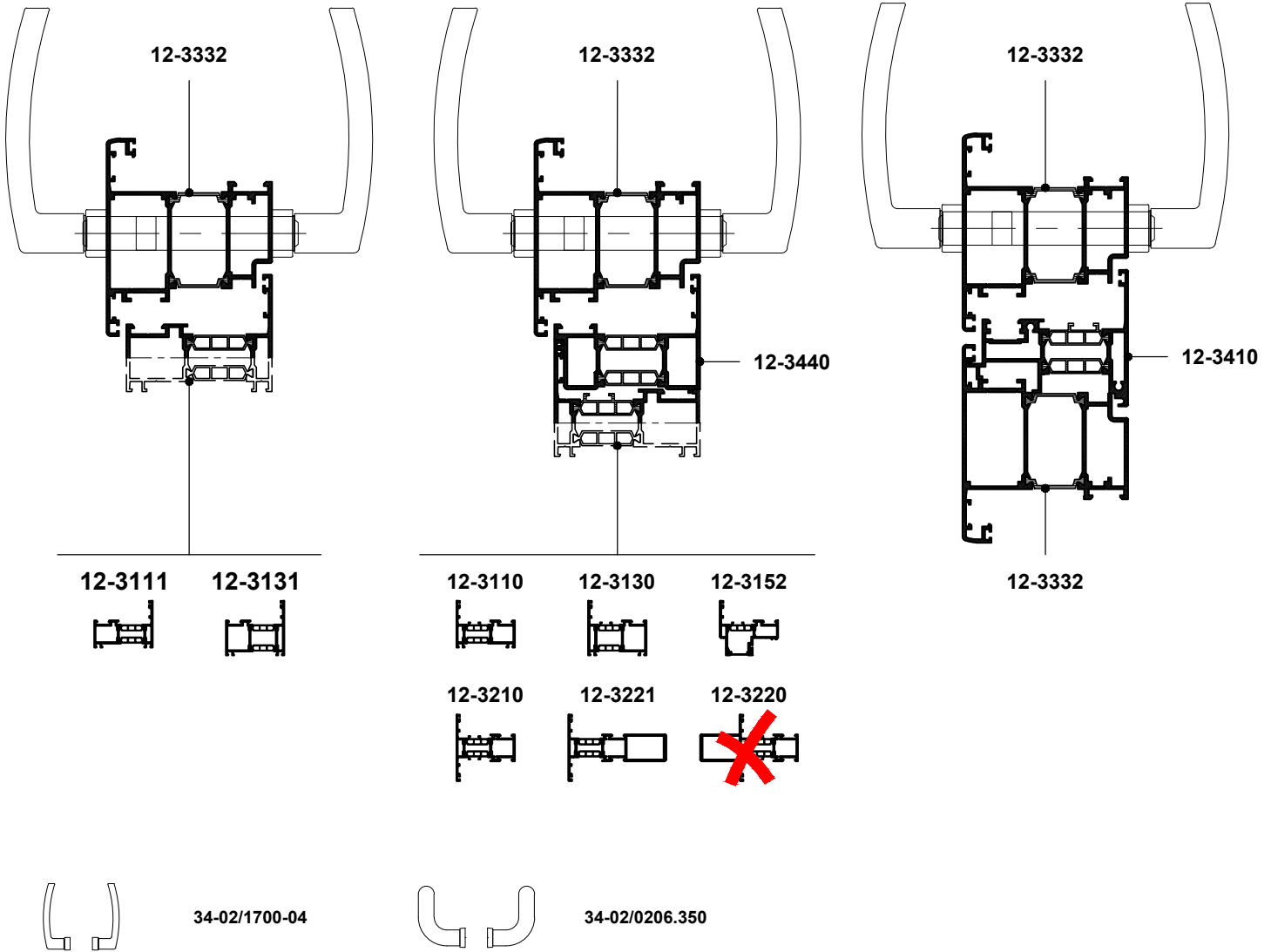

Ручка				Накладка			Цилиндр фигурный
Внешний вид	Артикул	Наименование	Крепление	Внешний вид	Артикул	Крепление	Артикул
	34-02/1700-04	Гарнитур нажимной 24/92/76-84	46-DIN966 A2 M5x30 TX25 x3	-	-	-	34-01/0003/3075
	34-02/0206.350	Комплект ручек дверных стационарных	В комплекте		34-14/00001474	43-DIN7982C A2 3,9x13 TX15 x4	34-01/0003/3075



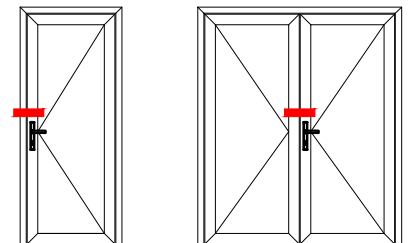
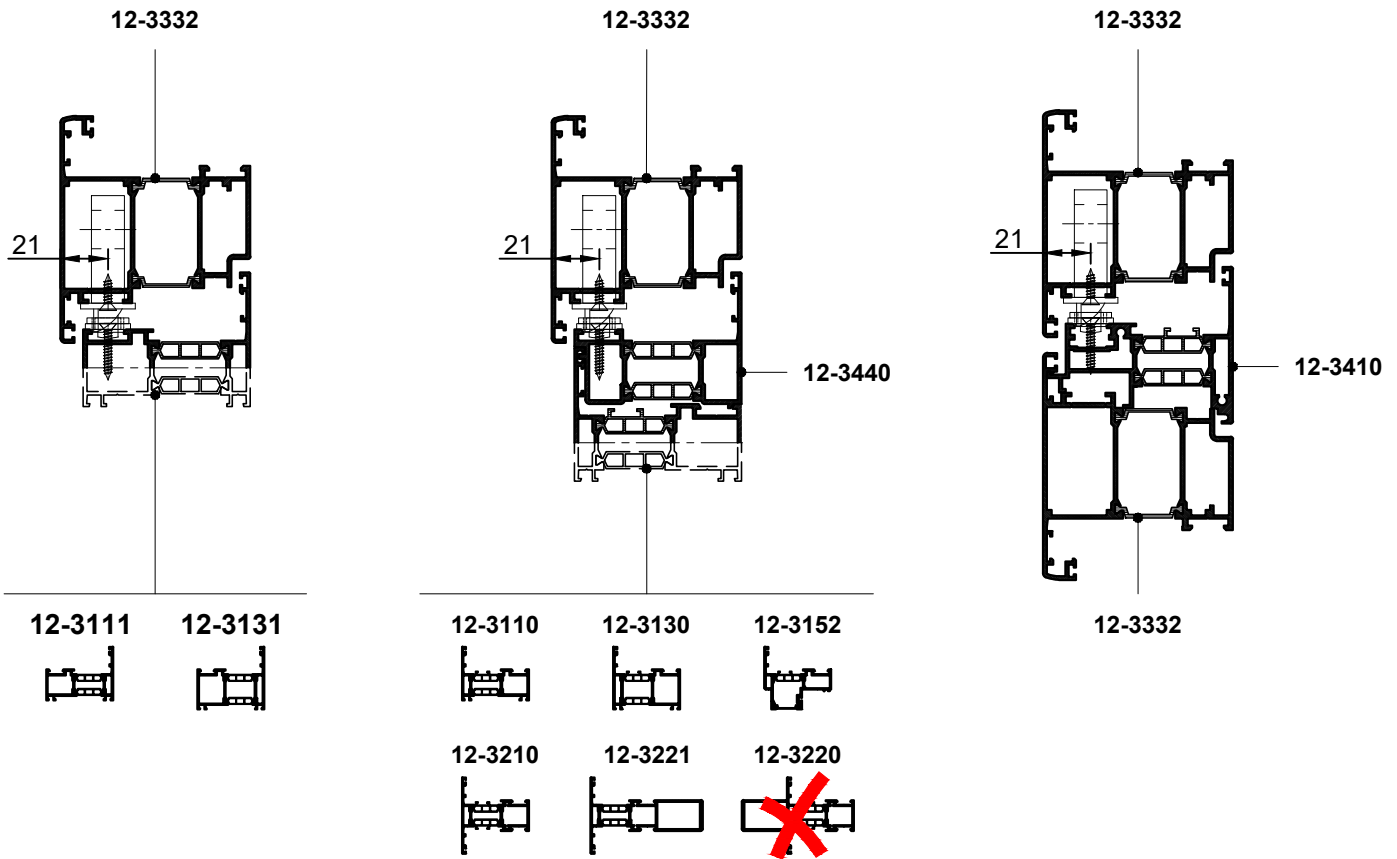

Замок				Планка ответная			Ручка
Внешний вид	Артикул	Наименование	Крепление	Внешний вид	Артикул	Крепление	
	34-04/1100000009810	Замок клиновыи 24x3/92/35	34-04/1100000009939 43-DIN7982C A2 3,9x16 TX15 x2		34-16/CT7777	43-DIN7982C A2 3,9x25 TX15 x3	34-02/1700-04 Гарнитур нажимной 24/92/76-84
	34-04/1100000009820	Замок роликовый 24x3/92/35	34-04/1100000009939 43-DIN7982C A2 3,9x16 TX15 x2		34-16/CT7777	43-DIN7982C A2 3,9x25 TX15 x3	34-02/0206.350 Комплект ручек дверных стационарных



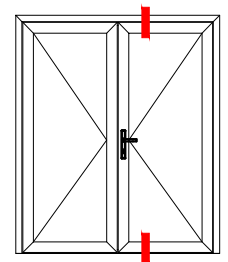
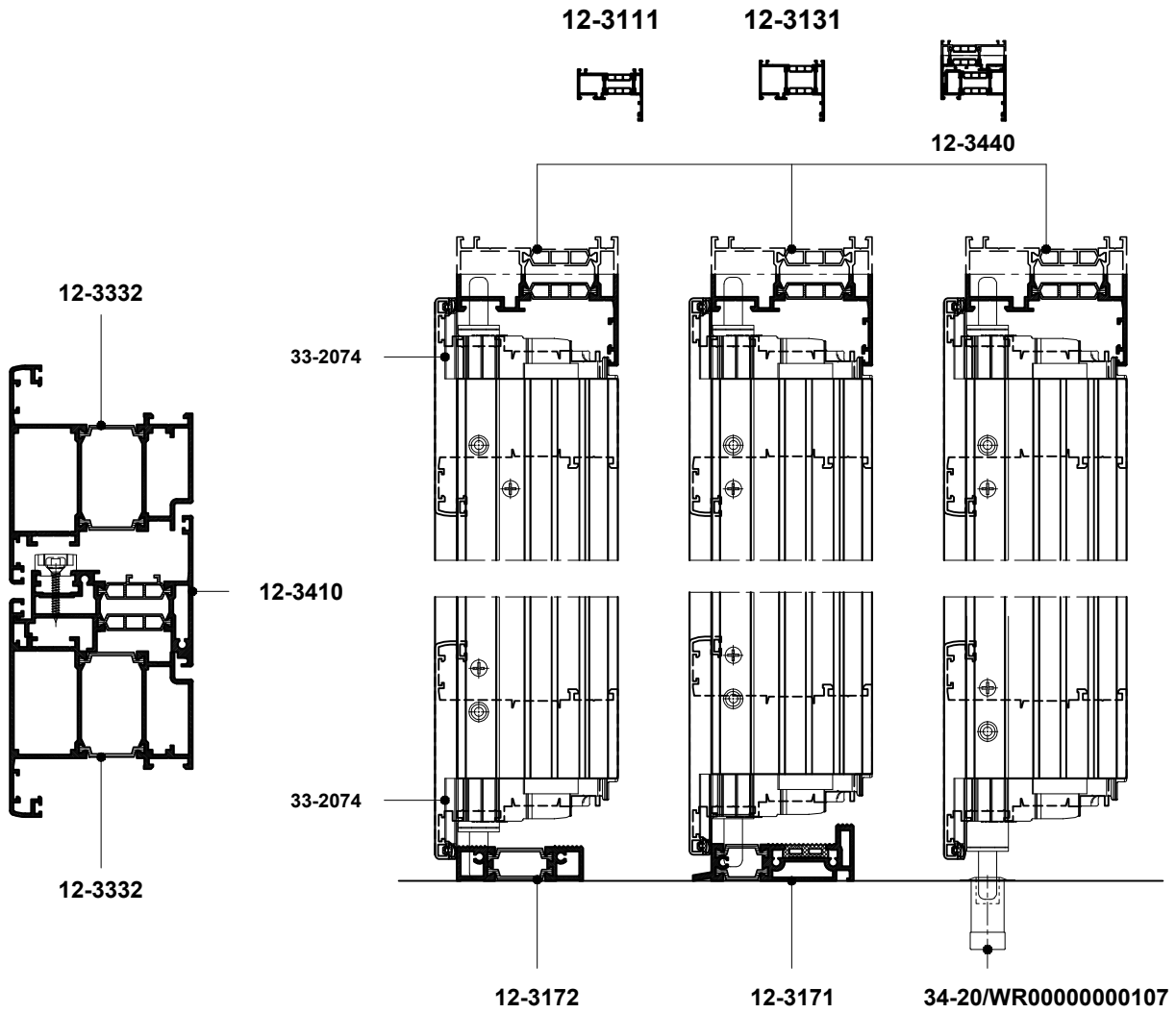

Шпингалет				Планка ответная			Примыкающий элемент
Внешний вид	Артикул	Наименование	Крепление	Внешний вид	Артикул	Крепление	Артикул
	34-19/052402[xx]	Шпингалет 19x8x220	В комплекте	-	-	-	12-3111 12-3131 12-3172 12-3171 12-3440
					34-20/WR00000000107	-	Пол



12-3310



12-3320

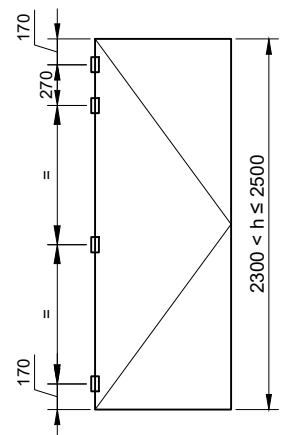
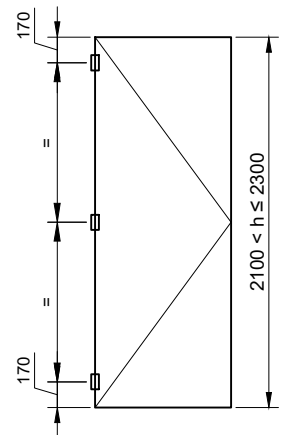
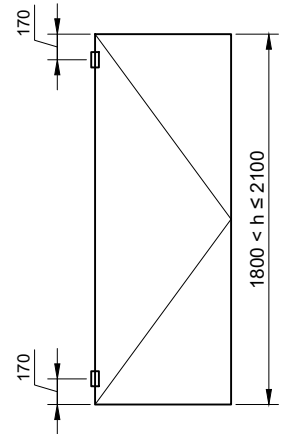
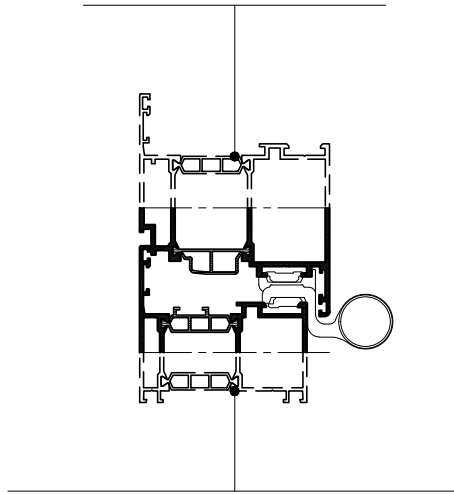

12-3110



12-3130



12-3152



12-3210



12-3220

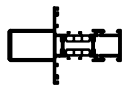

12-3221

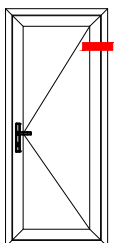

Навес			Ограничения		
Внешний вид	Артикул	Наименование	Ширина створки	Высота створки	Вес створки
	34-19/A011X[xx]	Навес двухчастный TAURUS	≤ 1200	≤ 2500	90 кг

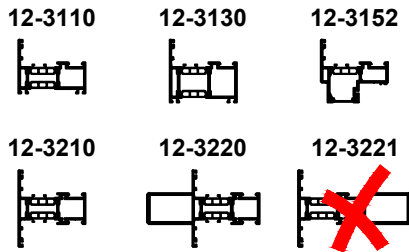
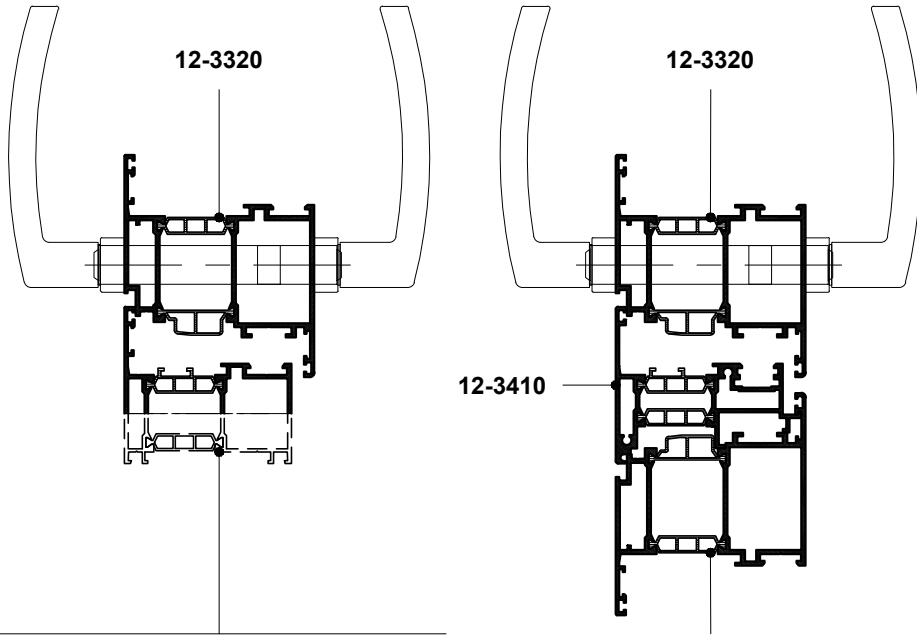

12-3320



34-02/1700-04

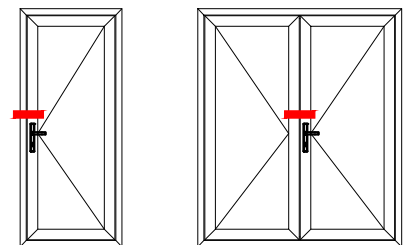

Ручка				Накладка			Цилиндр фигурный
Внешний вид	Артикул	Наименование	Крепление	Внешний вид	Артикул	Крепление	Артикул
	34-02/1700-04	Гарнитур нажимной 24/92/76-84	46-DIN966 A2 M5x90 TX25 x3	-	-	-	34-01/0003/3075

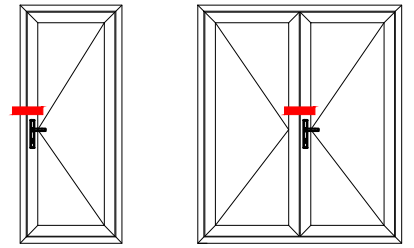
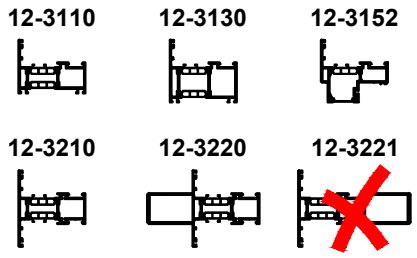
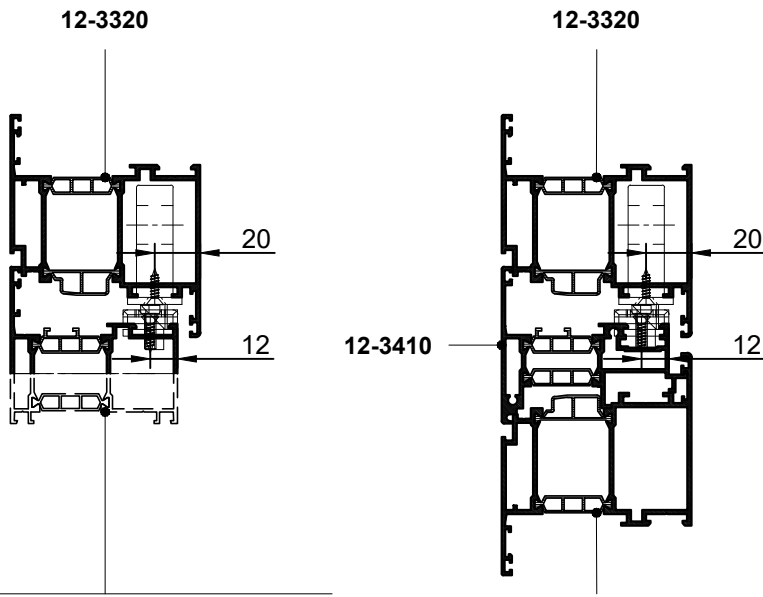

Замок				Планка ответная			Ручка
Внешний вид	Артикул	Наименование	Крепление	Внешний вид	Артикул	Крепление	
	34-22/3506068	Замок M3K KFV AS2750 24x3x2130-2400/35/92	43-DIN7982C A2 3,9x16 TX15 x10		34-03/3093.00 34-22/3478743 доп x2	43-DIN7982C A2 3,9x16 TX15 x6	34-02/1700-04 Гарнитура нажимной 24/92/76-84
					34-03/3093.00 34-22/3478743 доп x2		



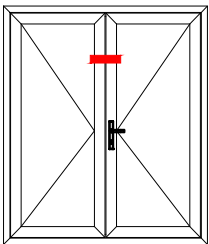
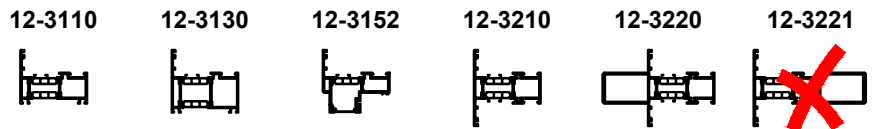
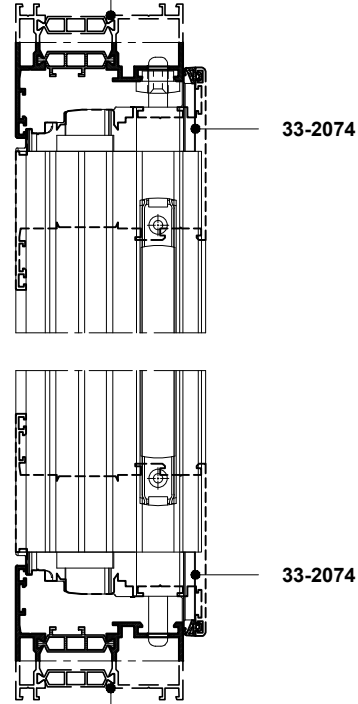
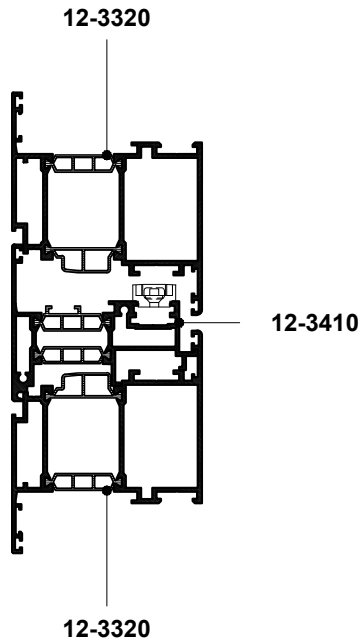
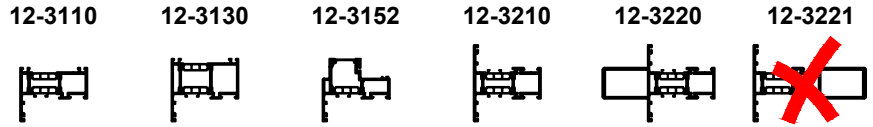

Шпингалет				Планка ответная			Примыкающий элемент
Внешний вид	Артикул	Наименование	Крепление	Внешний вид	Артикул	Крепление	Артикул
	34-19/052401[xx]	Шпингалет 19x8x140	В комплекте		34-19/0524020	В комплекте	12-3110 12-3130 12-3152 12-3210 12-3220