



Комплектация



Сборка



СОДЕРЖАНИЕ

- | | |
|------------|--|
| 01. | Содержание, оглавление, термины |
| 02. | Профили |
| 03. | Уплотнители, пластиковые адаптеры и вставки,
термомосты |
| 04. | Комплекующие и аксессуары |
| 05. | Сечения |
| 06. | Узлы |
| 07. | Остекление |
| 08. | Фурнитура |
| 09. | Сборка |



Сечение	Артикул Наименование	I_x см ⁴	W_x см ³	S см ²
		I_y см ⁴	W_y см ³	P мм
	<p>11-4110 Рама 47 мм</p>	$\frac{3,5}{8,9}$	$\frac{1,4}{3,01}$	$\frac{2,9}{292}$
	<p>11-4120 Рама 65 мм для створки-Т</p>	$\frac{9,1}{15,8}$	$\frac{3,6}{4,18}$	$\frac{4,5}{281}$

Профиль	Сухари		Химия	Комплекующие			
	Чаша I	Чаша II		Сбивка угла на прессе		Сборка угла на штифтах	
				Чаша I	Чаша II	Чаша I	Чаша II
Соединение L							
11-4110	20-0130/0412			31-0011		40-DIN1481 A2 D5x12 x2 31-0011	
11-4120	20-0370/0327					40-DIN1481 A2 D5x12 x2	
Соединение T							
11-4110	20-1400/0137					40-DIN1481 A2 D5x8 x4 40-DIN916 A2 M8x12 HEX4	



Сечение	Артикул Наименование	I_x см ⁴	W_x см ³	S см ²
		I_y см ⁴	W_y см ³	P мм
	<p>11-4121 Рама 70 мм для створки-Т</p>	-	-	-
	<p>11-4130 Рама 54 мм</p>	$\frac{5,4}{10,4}$	$\frac{2,12}{3,2}$	$\frac{4,32}{306}$

Профиль	Сухари		Химия	Комплекующие			
	Чаша I	Чаша II		Сбивка угла на прессе		Сборка угла на штифтах	
				Чаша I	Чаша II	Чаша I	Чаша II
Соединение L							
11-4121	20-0300/0412			31-0011		40-DIN1481 A2 D5x12 x2 31-0011	
11-4130	20-0200/0412			31-0011		40-DIN1481 A2 D5x12 x2 31-0011	
Соединение T							
11-4130	20-1400/0207					40-DIN1481 A2 D5x12 x4 40-DIN916 A2 M8x12 HEX4	



Сечение		Артикул Наименование	I_x см ⁴	W_x см ³	S см ²
			I_y см ⁴	W_y см ³	P мм
		11-4131 Рама 64 мм	$\frac{8,7}{14,1}$	$\frac{3,5}{3,78}$	$\frac{4,7}{327}$
		11-4170 Порог 16 мм			

Профиль	Сухари		Химия	Комплекующие			
	Чаша I	Чаша II		Сбивка угла на прессе		Сборка угла на штифтах	
				Чаша I	Чаша II	Чаша I	Чаша II
Соединение L							
11-4131	20-0300/0412			31-0011		40-DIN1481 A2 D5x12 x2 31-0011	
Соединение T							
11-4131	20-1400/0307					40-DIN1481 A2 D5x12 x4 40-DIN916 A2 M8x12 HEX4	



Сечение	Артикул Наименование	I_x см ⁴	W_x см ³	S см ²
		I_y см ⁴	W_y см ³	P мм
	11-4210 Импост 67 мм	$\frac{7,7}{9,2}$	$\frac{2,76}{2,75}$	$\frac{4,7}{362}$
	11-4211 Импост 74 мм	$\frac{10,3}{11,2}$	$\frac{3,7}{3,03}$	$\frac{5,02}{376}$

Профиль	Сухари		Химия	Комплектующие			
	Чаша I	Чаша II		Сбивка угла на прессе		Сборка угла на штифтах	
				Чаша I	Чаша II	Чаша I	Чаша II
Соединение L							
11-4210	20-0130/0412			31-0011	x2	40-DIN1481 A2 D5x12	x4
						31-0011	x2
11-4211	20-0200/0412			31-0011	x2	40-DIN1481 A2 D5x12	x4
						31-0011	x2
Соединение T							
11-4210	20-1400/0137					40-DIN1481 A2 D5x8	x4
						40-DIN916 A2 M8x12 HEX4	
11-4211	20-1400/0207					40-DIN1481 A2 D5x12	x4
						40-DIN916 A2 M8x12 HEX4	



Сечение				Артикул	I_x см ⁴	W_x см ³	S см ²
				Наименование	I_y см ⁴	W_y см ³	P мм
				11-4220 Импост 67 мм усиленный	$\frac{9,7}{29,7}$	$\frac{2,4}{8,87}$	$\frac{6,6}{431}$
Профиль	Сухари		Химия	Комплектующие			
	Чаша I	Чаша II		Сбивка угла на прессе		Сборка угла на штифтах	
				Чаша I	Чаша II	Чаша I	Чаша II
Соединение L							
11-4220	20-0130/0412			31-0011	x2	40-DIN1481 A2 D5x12	x4
						31-0011	x2
11-4221	20-0130/0412			31-0011	x2	40-DIN1481 A2 D5x12	x4
						31-0011	x2
Соединение T							
11-4220	20-1400/0137					40-DIN1481 A2 D5x8	x4
						40-DIN916 A2 M8x12 HEX4	
11-4221	20-1400/0137					40-DIN1481 A2 D5x8	x4
						40-DIN916 A2 M8x12 HEX4	



Сечение	Артикул Наименование	I_x см ⁴	W_x см ³	S см ²
		I_y см ⁴	W_y см ³	P мм
	<p>11-4222 Импост 67 мм усиленный</p>	-	-	-
	<p>11-4230 Импост 74 мм в створку</p>	$\frac{11,5}{16,6}$	$\frac{3,5}{4,49}$	$\frac{3,96}{396}$

Профиль	Сухари		Химия	Комплекующие			
	Чаша I	Чаша II		Сбивка угла на прессе		Сборка угла на штифтах	
				Чаша I	Чаша II	Чаша I	Чаша II
Соединение L							
11-4222	20-0130/0412			31-0011	x2	40-DIN1481 A2 D5x12	x4
						31-0011	x2
Соединение T							
11-4222	20-1400/0137					40-DIN1481 A2 D5x8	x4
						40-DIN916 A2 M8x12 HEX4	
11-4230	20-1500/0207					40-DIN1481 A2 D5x12	x4
						40-DIN916 A2 M8x12 HEX4	



Сечение				Артикул	I_x см ⁴	W_x см ³	S см ²
				Наименование	I_y см ⁴	W_y см ³	P мм
				11-4310 Створка 66 мм	$\frac{4,4}{18,8}$	$\frac{1,5}{5,64}$	$\frac{5,11}{363}$
				11-4320 Створка 98 мм	$\frac{16,8}{40,3}$	$\frac{5,9}{8,14}$	$\frac{6,45}{427}$
Профиль	Сухари		Химия	Комплекующие			
	Чаша I	Чаша II		Сбивка угла на прессе		Сборка угла на штифтах	
				Чаша I	Чаша II	Чаша I	Чаша II
Соединение L							
11-4310	20-0130/0433			31-0010 31-0011		40-DIN1481 A2 D5x12 x2 31-0010 31-0011	
11-4320	20-0440/0433			31-0010 31-0011		40-DIN1481 A2 D5x12 x2 31-0010 31-0011	



Сечение		Артикул Наименование	I_x см ⁴ I_y см ⁴	W_x см ³ W_y см ³	S см ² P мм
		<p>11-4330 Створка-Т 92 мм</p>	$\frac{13,5}{26,6}$	$\frac{5,1}{5,75}$	$\frac{4,38}{366}$

Профиль	Сухари		Химия	Комплектующие			
	Чаша I	Чаша II		Сбивка угла на прессе		Сборка угла на штифтах	
	Чаша I	Чаша II		Чаша I	Чаша II	Чаша I	Чаша II
Соединение L							
11-4330	20-0440/0327			31-0011		40-DIN1481 A2 D5x12 x2 31-0011	



Сечение	Артикул Наименование	I_x см ⁴	W_x см ³	S см ²
		I_y см ⁴	W_y см ³	P мм
	<p>11-4340 Створка-Z 92 мм</p>	$\frac{10,9}{30}$	$\frac{4,8}{6,5}$	$\frac{4,38}{366}$

Профиль	Сухари		Химия	Комплектующие			
	Чаша I	Чаша II		Сбивка угла на прессе		Сборка угла на штифтах	
				Чаша I	Чаша II	Чаша I	Чаша II
Соединение L							
11-4340	20-0440/0327			31-0011		40-DIN1481 A2 D5x12 x2 31-0011	



Сечение				Артикул Наименование		I_x см ⁴ I_y см ⁴	W_x см ³ W_y см ³	S см ² P мм
				<p>11-4350 Створка-Т 98 мм</p>		$\frac{22,5}{40,9}$	$\frac{6,7}{8,1}$	$\frac{5,4}{481}$
Профиль	Сухари		Химия	Комплекующие				
	Чаша I	Чаша II		Сбивка угла на прессе		Сборка угла на штифтах		
	Чаша I	Чаша II	Чаша I	Чаша II	Чаша I	Чаша II		
Соединение L								
11-4350	20-0440/0433			31-0010 31-0011		40-DIN1481 A2 D5x12 x2 31-0010 31-0011		



Сечение	Артикул Наименование	I_x см ⁴	W_x см ³	S см ²
		I_y см ⁴	W_y см ³	P мм
	<p>11-4360 Створка-Т 97 мм</p>			<p>0 0</p>

Профиль	Сухари		Химия	Комплектующие			
	Чаша I	Чаша II		Сбивка угла на прессе		Сборка угла на штифтах	
				Чаша I	Чаша II	Чаша I	Чаша II
Соединение L							
11-4360	20-0370/0412			31-0011	x2	40-DIN1481 A2 D5x12	x2
						31-0011	x2



Сечение				Артикул	I_x см ⁴	W_x см ³	S см ²
				Наименование	I_y см ⁴	W_y см ³	P мм
				11-4370 Створка-Z 97 мм			0
							0
				11-4410 Штульп 57 мм			3,7
							308
Профиль	Сухари		Химия	Комплекующие			
	Чаша I	Чаша II		Сбивка угла на прессе		Сборка угла на штифтах	
				Чаша I	Чаша II	Чаша I	Чаша II
Соединение L							
11-4370	20-0370/0412			31-0011	x2	40-DIN1481 A2 D5x12 x2	31-0011 x2

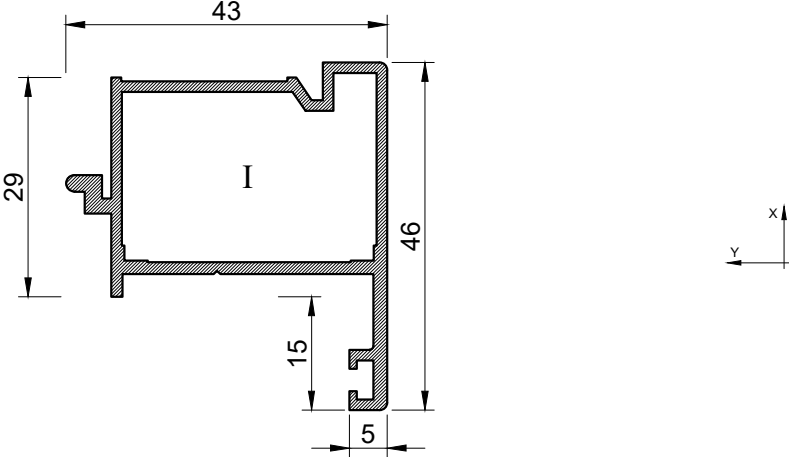
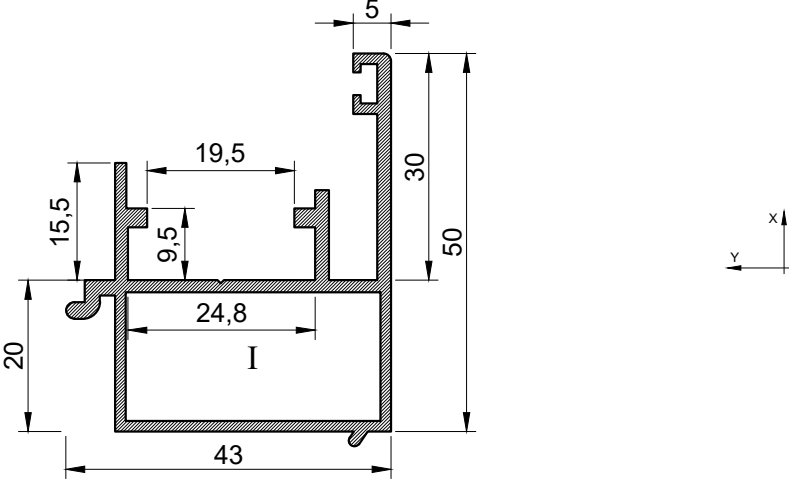
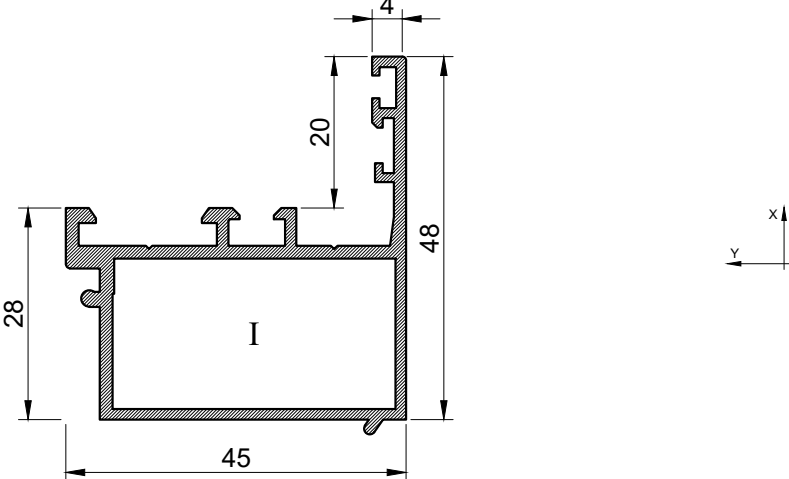

Сечение	Артикул Наименование	I_x см ⁴ I_y см ⁴	W_x см ³ W_y см ³	S см ² P мм
	<p>11-4420 Штульп 46 мм</p>			<p>2,6 210</p>
	<p>11-4431 Профиль оборачивающий</p>	<p>- -</p>	<p>- -</p>	<p>- -</p>
	<p>11-4440 Профиль оборачивающий</p>	<p>4,1 8,4</p>	<p>1,6 2,85</p>	<p>3 263</p>

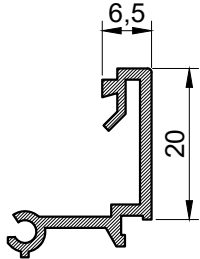
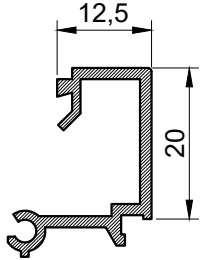
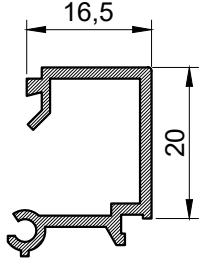
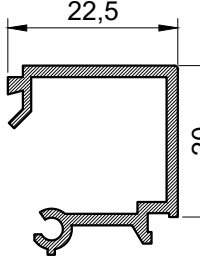
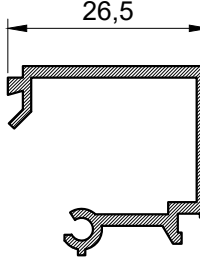
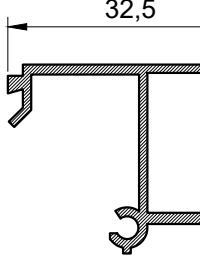

Сечение	Артикул Наименование	I_x см ⁴	W_x см ³	S см ²
		I_y см ⁴	W_y см ³	P мм
	10-6060 Штапик 6,5 мм x 20 мм			0,84 123
	10-6120 Штапик 12,5 мм x 20 мм			0,94 135
	10-6160 Штапик 16,5 мм x 20 мм			1 143
	10-6220 Штапик 22,5 мм x 20 мм			1,08 155
	10-6260 Штапик 26,5 мм x 20 мм			1,14 163
	10-6320 Штапик 32,5 мм x 20 мм			0 0

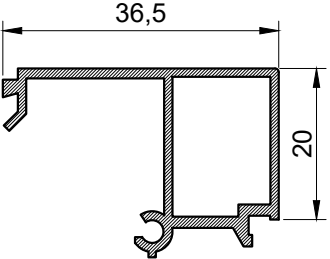

Сечение	Артикул Наименование	I_x см ⁴ I_y см ⁴	W_x см ³ W_y см ³	S см ² P мм
 <p>Technical drawing of an L-shaped profile. The horizontal leg has a length of 36,5 mm. The vertical leg has a height of 20 mm. The profile is shown in a cross-sectional view with hatching to indicate its solid nature.</p>	<p>10-6360 Штапик 36,5 мм x 20 мм</p>			<p>0 0</p>

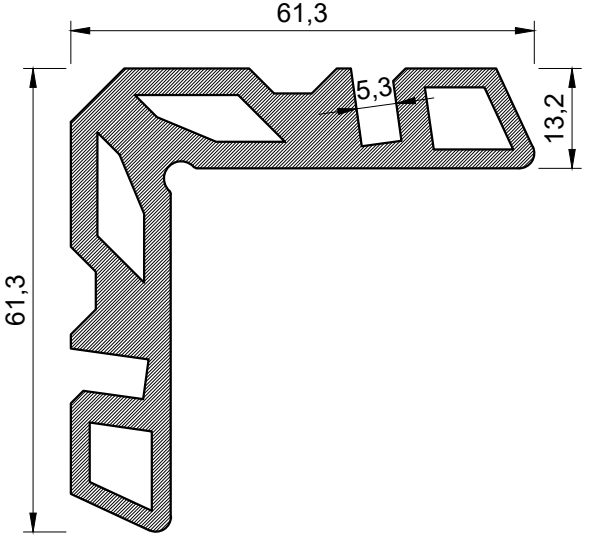
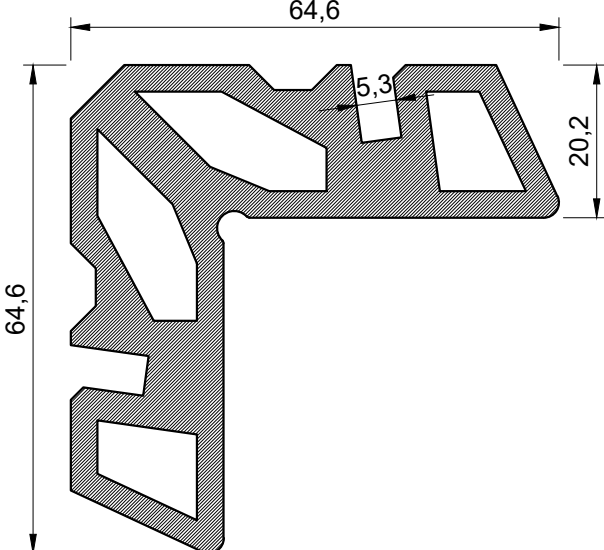

Сечение	Артикул Наименование	I_x см ⁴ I_y см ⁴	W_x см ³ W_y см ³	S см ² P мм
	<p>10-0130 Сухарь 13,2 мм</p>			<p>89,9 271</p>
	<p>10-0200 Сухарь 20,2 мм</p>			<p>125 279</p>

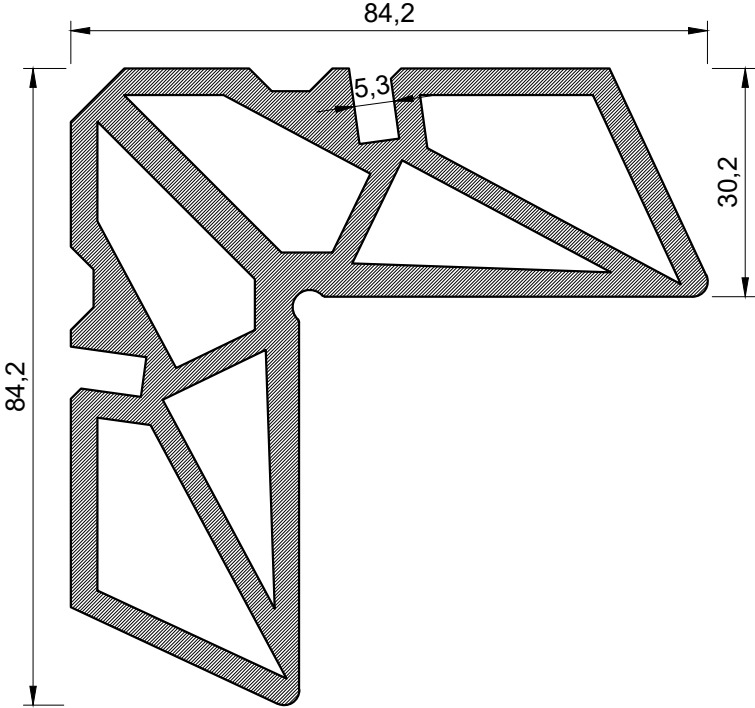
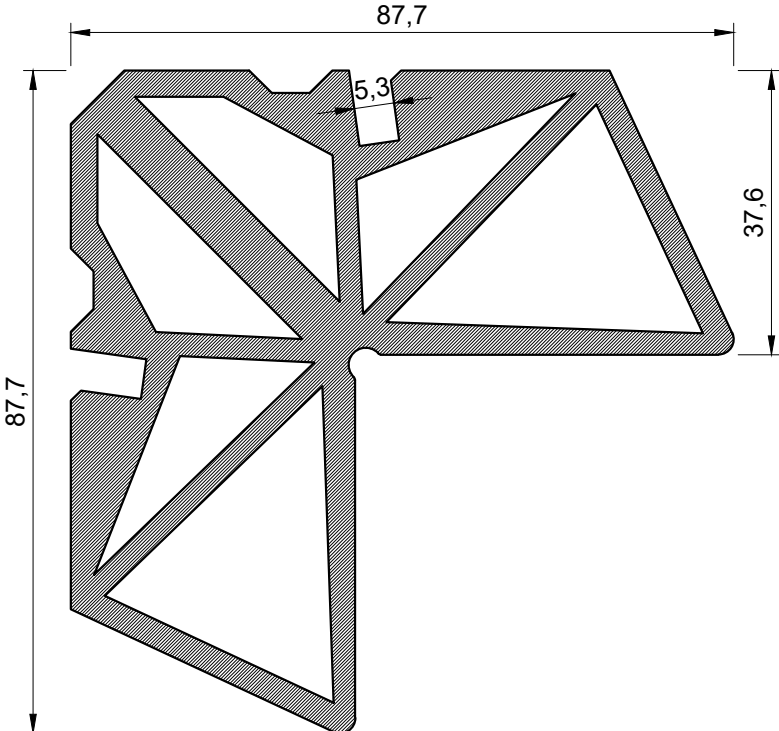

Сечение	Артикул Наименование	I_x см ⁴ I_y см ⁴	W_x см ³ W_y см ³	S см ² P мм
	<p>10-0300 Сухарь 30,2 мм</p>			<p>0 0</p>
	<p>10-0370 Сухарь 37,6 мм</p>			<p>208 358</p>



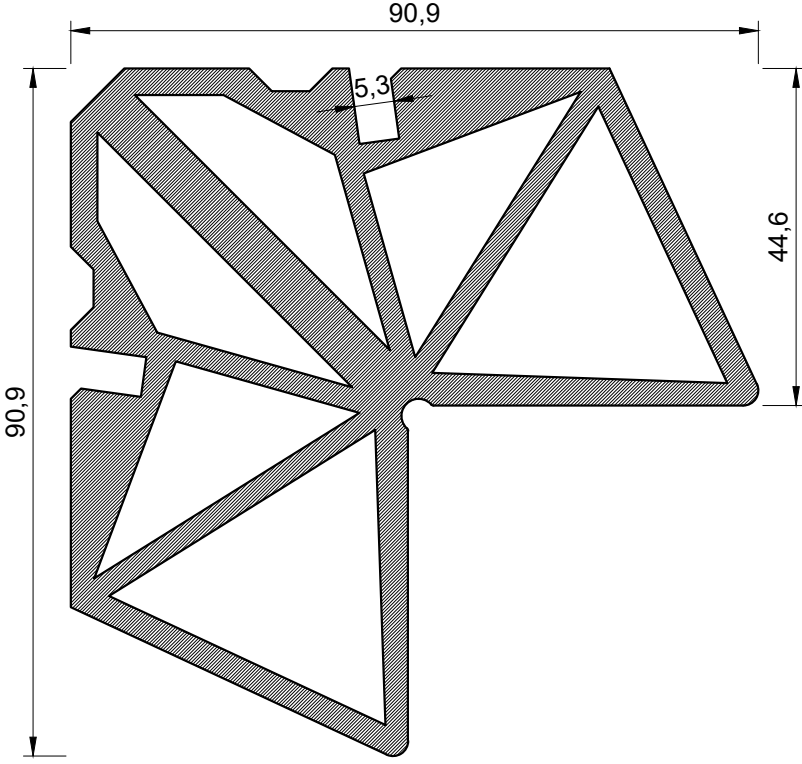

Сечение	Артикул Наименование	I_x см ⁴ I_y см ⁴	W_x см ³ W_y см ³	S см ² P мм
	<p>10-0440 Сухарь 44,6 мм</p>			<p>224 366</p>

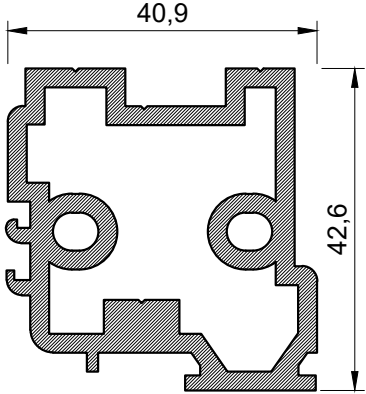
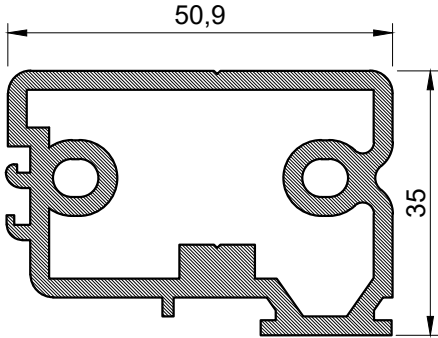
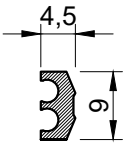
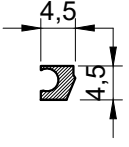



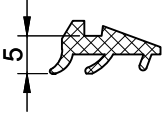

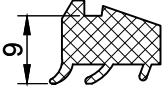
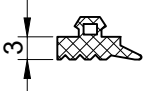
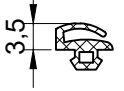
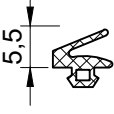
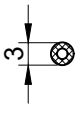



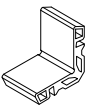

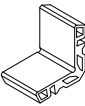

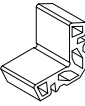

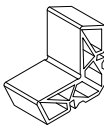

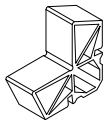

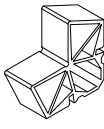

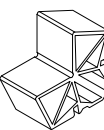
Сечение	Артикул Наименование	I_x см ⁴ I_y см ⁴	W_x см ³ W_y см ³	S см ² P мм
	<p>10-1400 Сухарь 40,9 мм крепления импоста</p>			<p>0 0</p>
	<p>10-1500 Сухарь 50,9 мм крепления импоста</p>			<p>0 0</p>
	<p>10-5060 Профиль стыковочный</p>			<p>2,9 35</p>
	<p>10-5050 Профиль крепления мембраны</p>			<p>1,4 22</p>











Сечение	Ед. Изм.	Н.У.	Артикул Наименование
	пог. м	250	50-1251 Уплотнитель под штапик 5 мм
	пог. м	200	50-1271 Уплотнитель под штапик 7 мм
	пог. м	200	50-1291 Уплотнитель под штапик 9 мм
	пог. м	300	50-2031 Уплотнитель под СП 3 мм
	пог. м	400	50-3032 Уплотнитель притвора 3,5 мм
	пог. м	400	50-3050 Уплотнитель притвора 5 мм
	пог. м	500	50-7009 Уплотнитель круглый Д3 мм

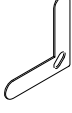

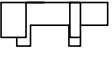
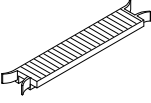
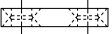
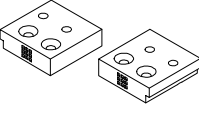

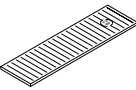

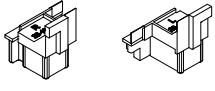





Сечение	Внешний вид	Ед. Изм.	Н.У.	Артикул Наименование
		шт.	1	20-0130/0412 Сухарь 13,2 мм х41,2 мм
		шт.	1	20-0130/0433 Сухарь 13,2 мм х43,3 мм
		шт.	1	20-0200/0412 Сухарь 20,2 мм х41,2 мм
		шт.	1	20-0300/0412 Сухарь 30,2 мм х41,2 мм
		шт.	1	20-0370/0327 Сухарь 37,6 мм х32,7 мм
		шт.	1	20-0440/0327 Сухарь 44,6 мм х32,7 мм
		шт.	1	20-0440/0433 Сухарь 44,6 мм х43,3 мм
		шт.	1	20-1400/0137 Сухарь 40,9 мм х13,7 мм
		шт.	1	20-1400/0207 Сухарь 40,9 мм х20,7 мм
		шт.	1	20-1400/0307 Сухарь 40,9 мм х30,7 мм
		шт.	1	20-1500/0207 Сухарь 50,9 мм х20,7 мм

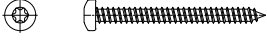

Сечение	Внешний вид	Ед. Изм.	Н.У.	Артикул Наименование
		шт.	50	31-0010 Уголок выравнивающий
		шт.	50	31-0011 Уголок выравнивающий
		шт.	10	32-0020 Крышка дренажная оконная
		шт.	1	32-1620 Опора СП 20 мм
		пара	1	32-1845 Комплект креплений порога WD45
		шт.	100	32-6282 Пластина рихтовочная 28x2 мм
		компл.	1	33-1945 Комплект заглушек штульпа WD45

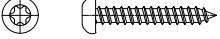
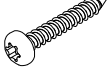
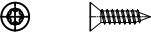

Сечение	Внешний вид	Ед. Изм.	Н.У.	Артикул Наименование
		шт.		40-DIN916 A2 M8x12 HEX4 Винт установочный с кантом
		шт.		40-DIN1481 A2 D5x8 Штифт
		шт.		40-DIN1481 A2 D5x12 Штифт
		шт.		41-DIN7981C A2 4,2x45 TX20 Шуруп с полукруглой головкой
		шт.		41-DIN7981C A2 4,8x32 TX25 Шуруп с полукруглой головкой
		шт.		43-DIN7982C A2 4,2x16 TX20 Шуруп с потайной головкой



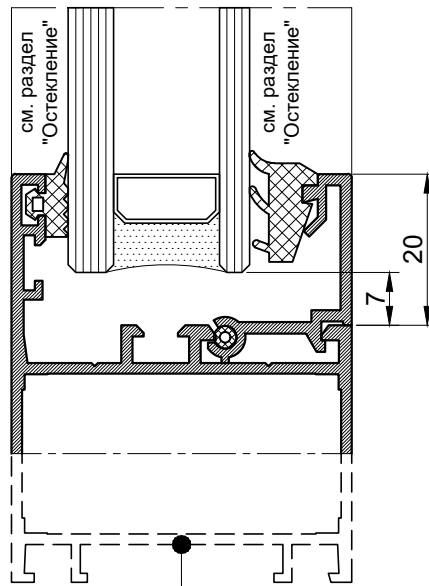
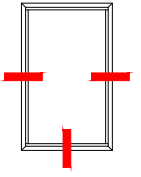

11-4110

11-4130

11-4131

11-4210

11-4211

11-4220

11-4221

11-4222

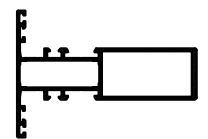
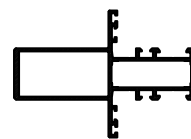
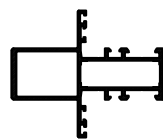
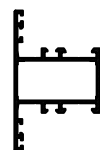
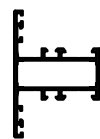
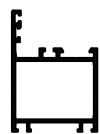
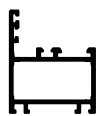
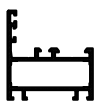

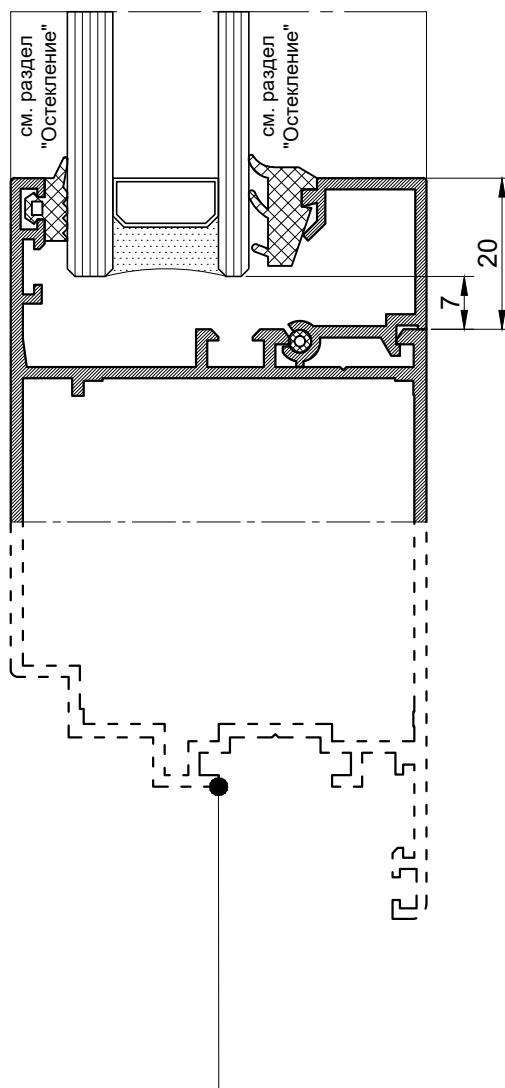
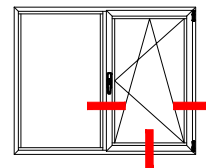

11-4310

11-4320

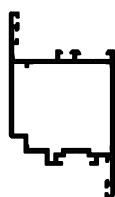
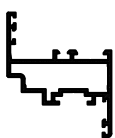

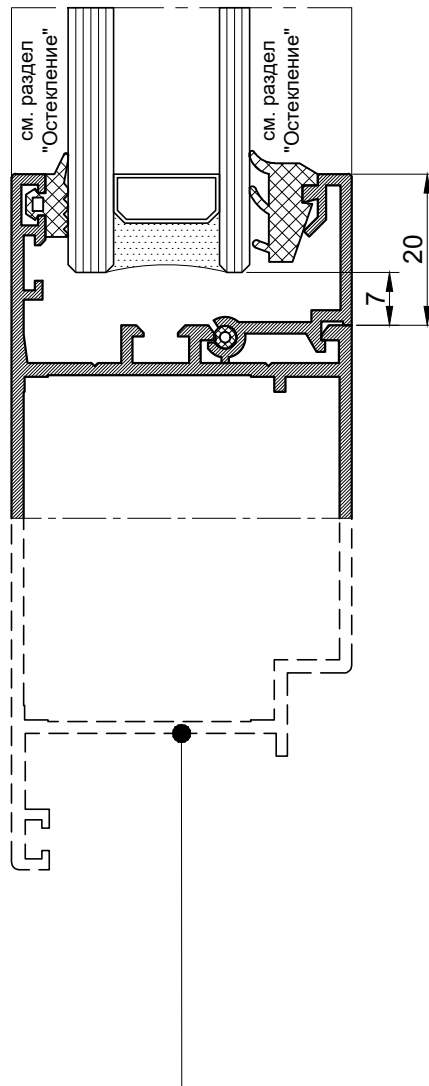
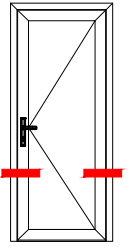

11-4330

11-4340

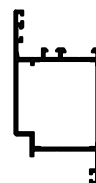
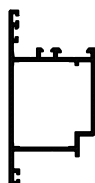

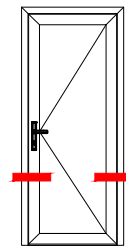

11-4350

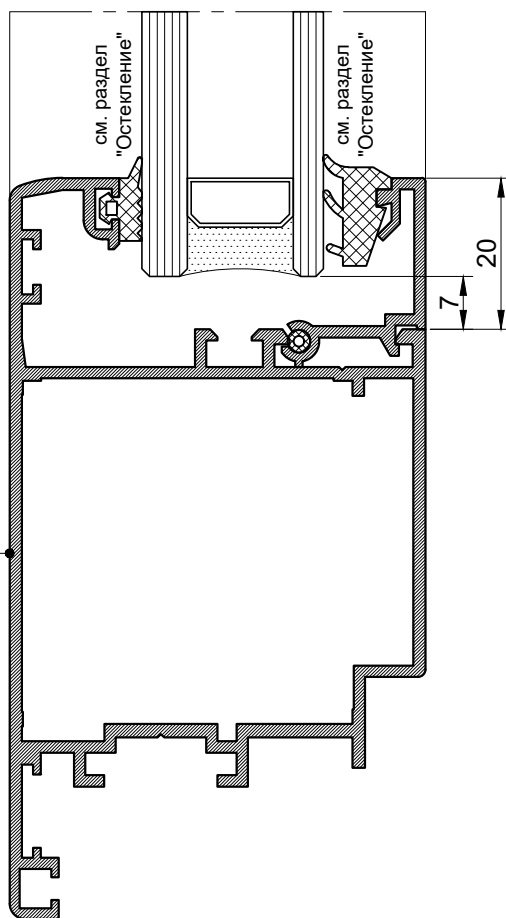

11-4310

11-4320

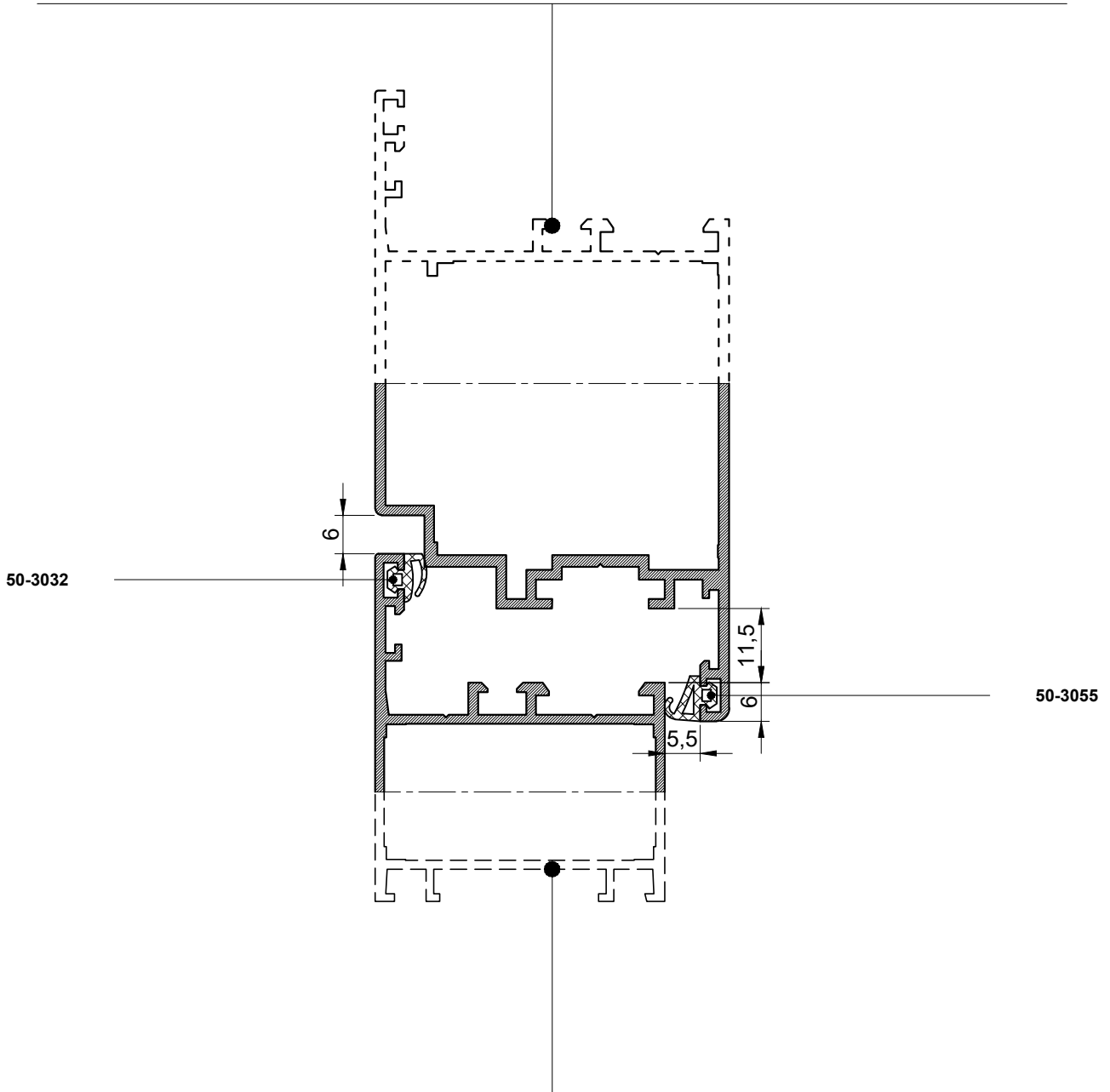
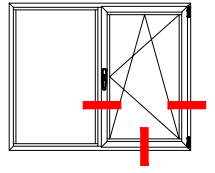
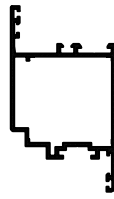
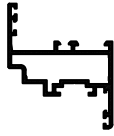

11-4110

11-4130

11-4131

11-4210

11-4211

11-4220

11-4221

11-4222

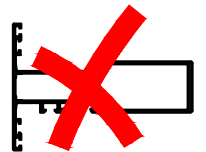
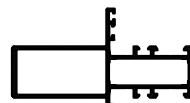
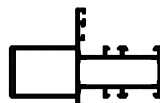
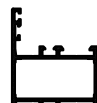
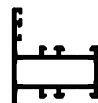
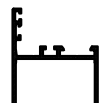
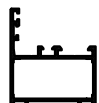
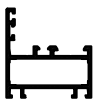

11-4310

11-4320

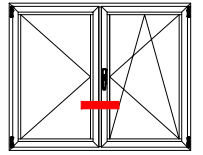
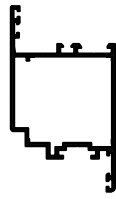
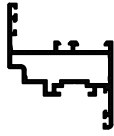

50-3032

11-4410

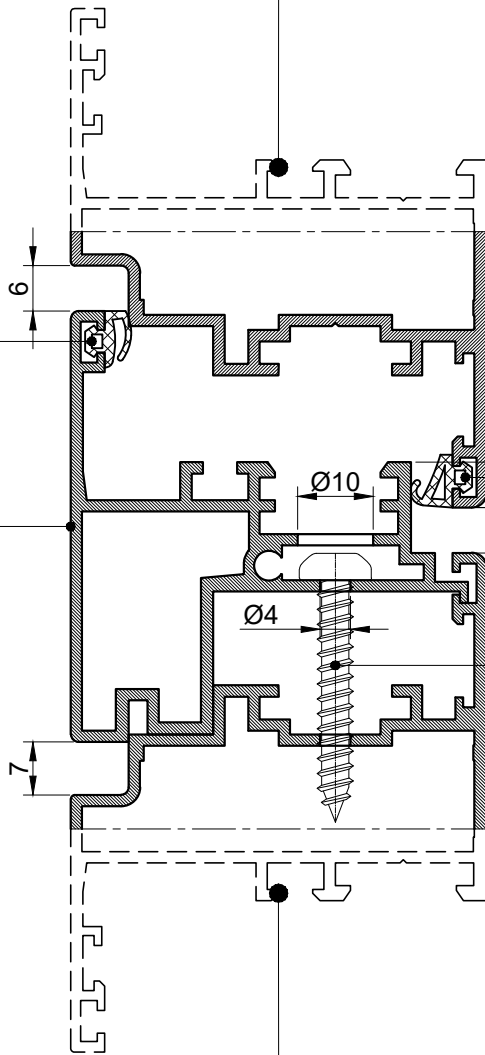

50-3055

41-DIN7981C A2
4,8x32 TX25
шаг 300 мм

11-4310

11-4320

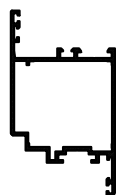
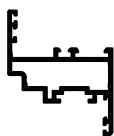

11-4110 11-4130 11-4131 11-4120 11-4121

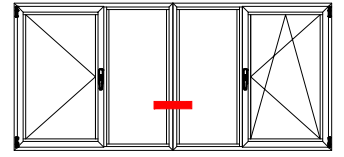
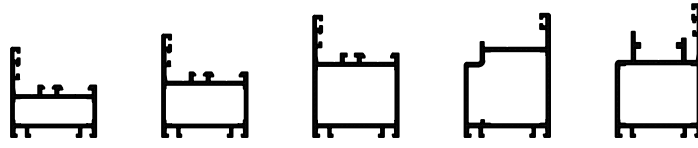

10-5060
50-7009

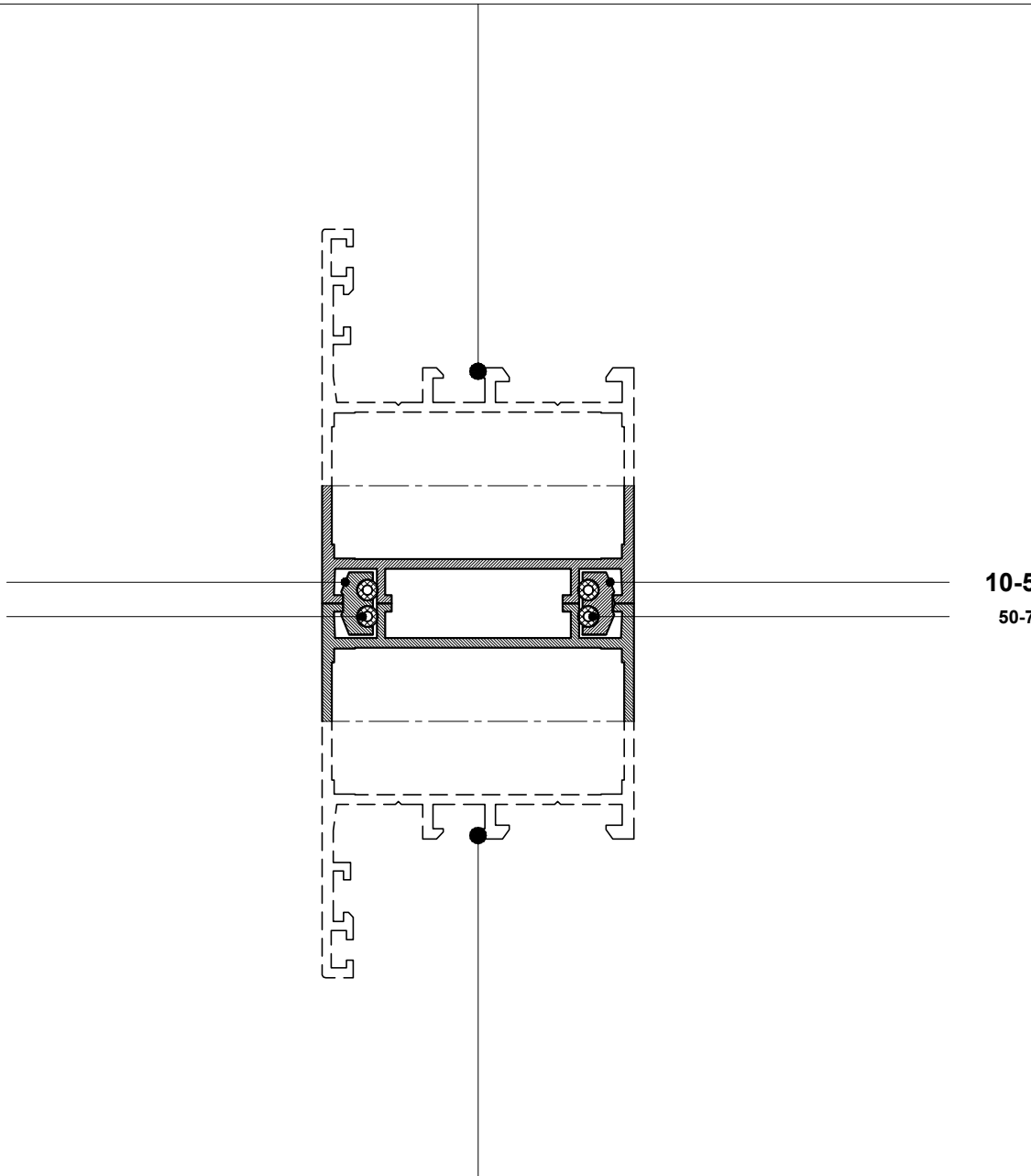

10-5060
50-7009

11-4110 11-4130 11-4131 11-4120 11-4121

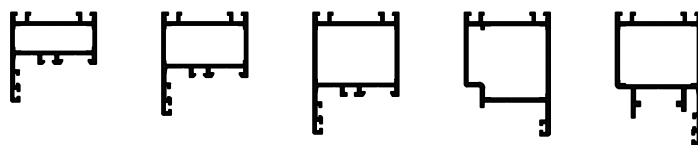

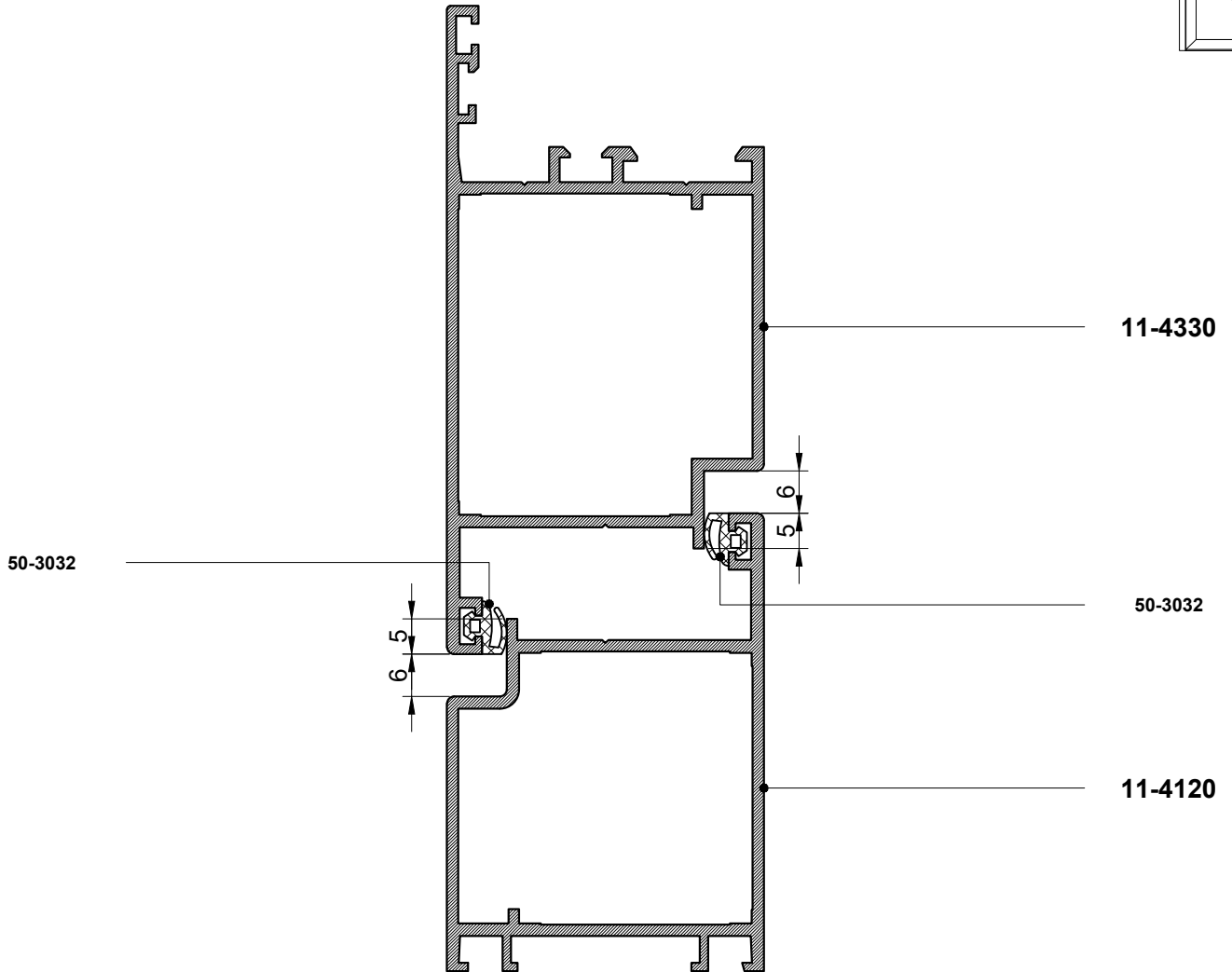
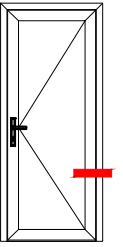

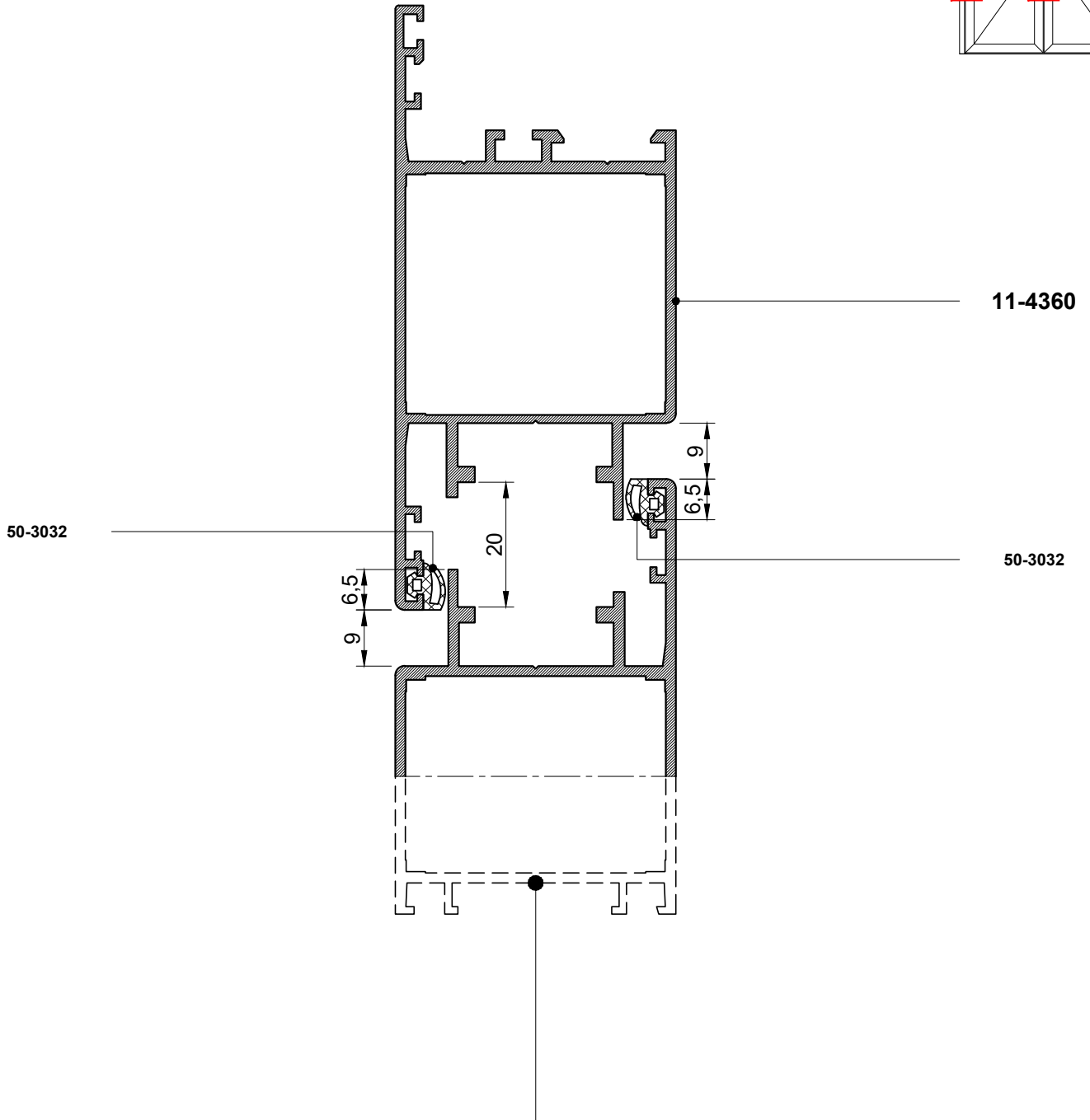
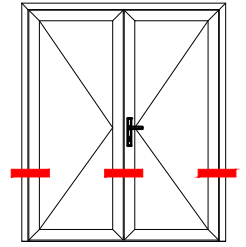

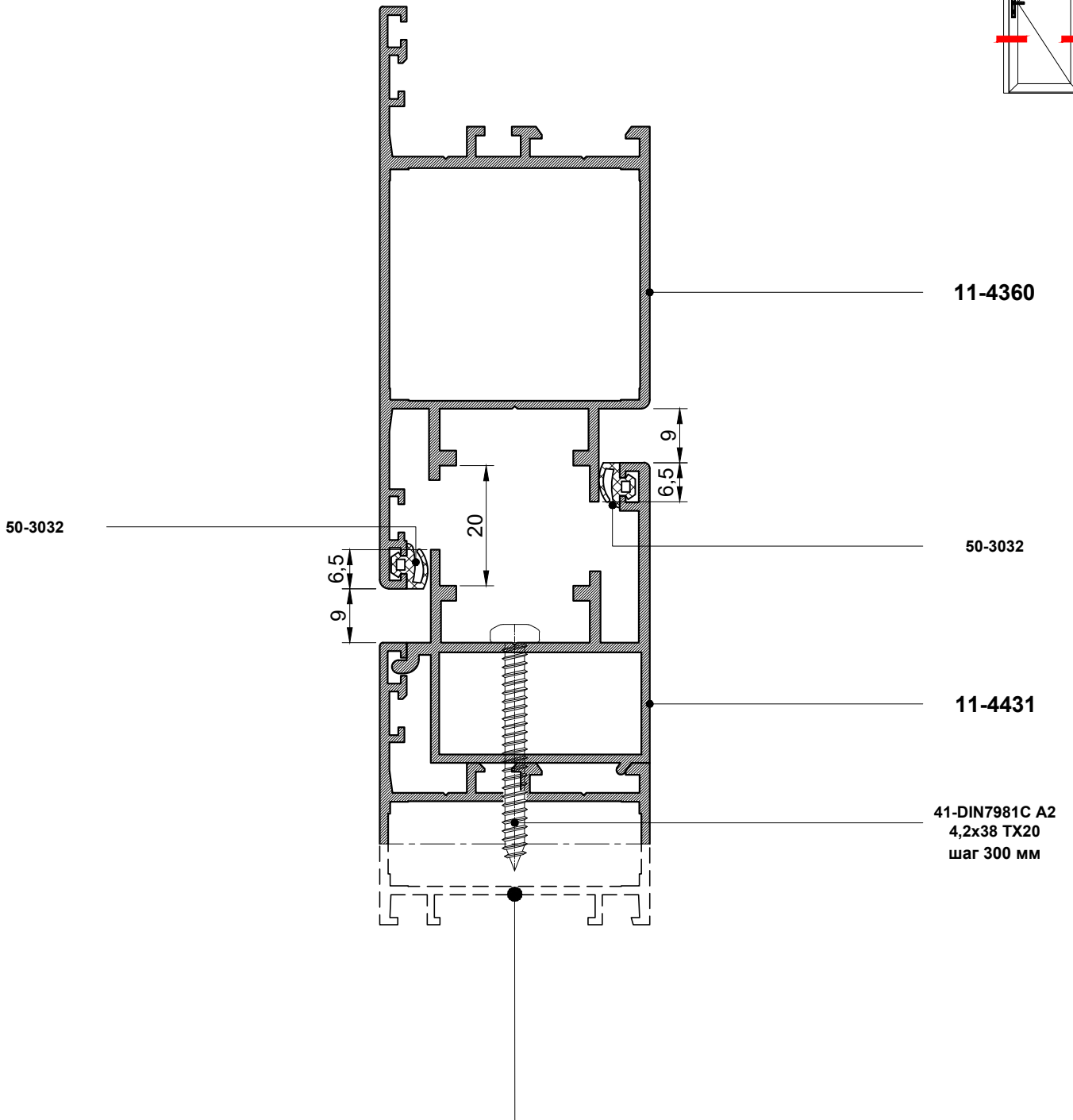
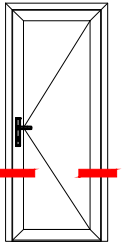

11-4110

11-4130

11-4131

11-4210

11-4211

11-4222

11-4220

11-4221

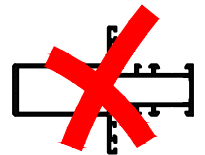
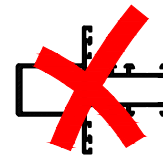
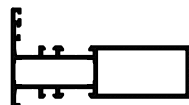
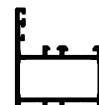
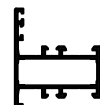
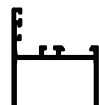
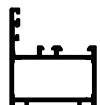

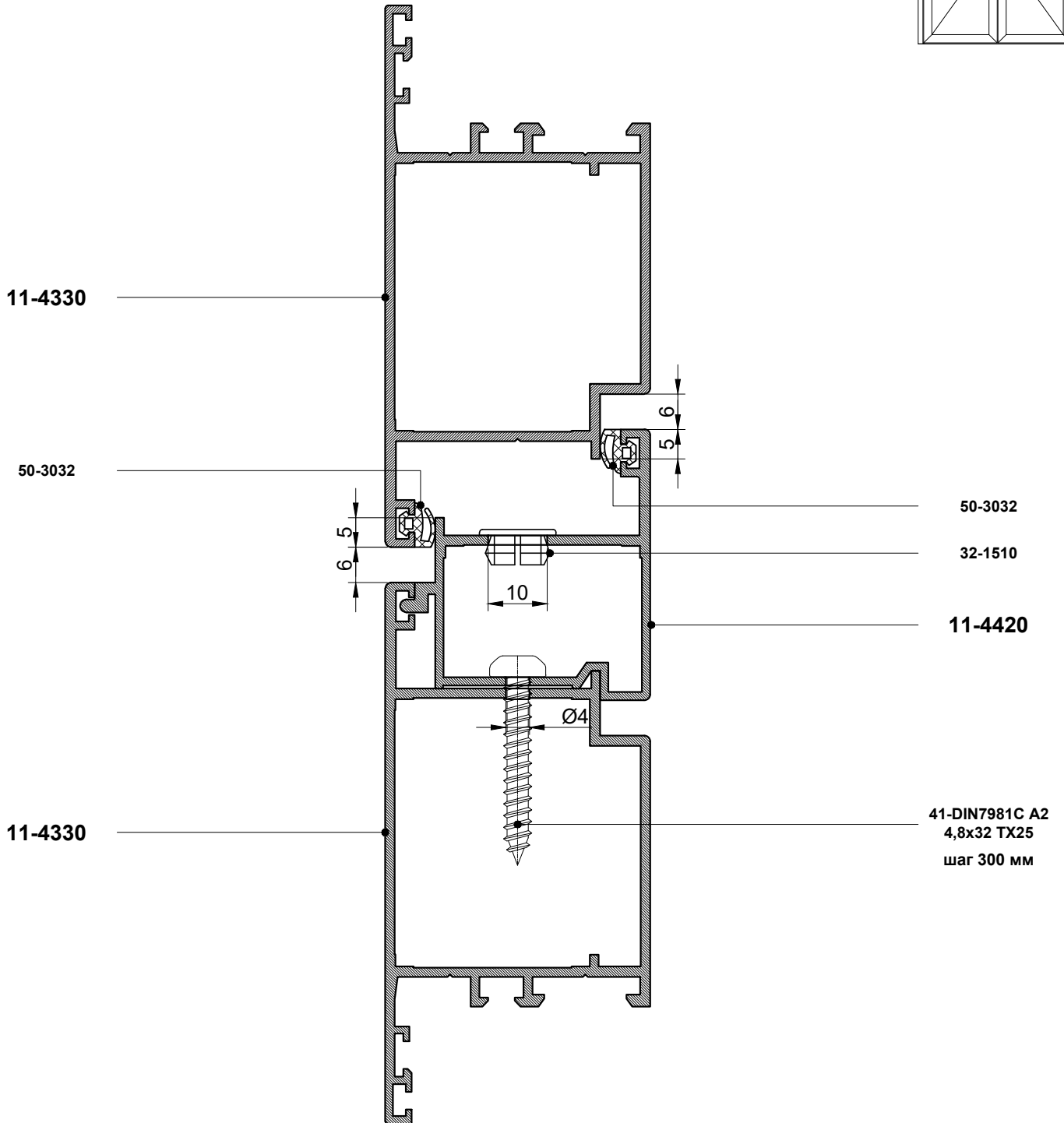
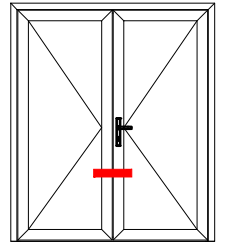

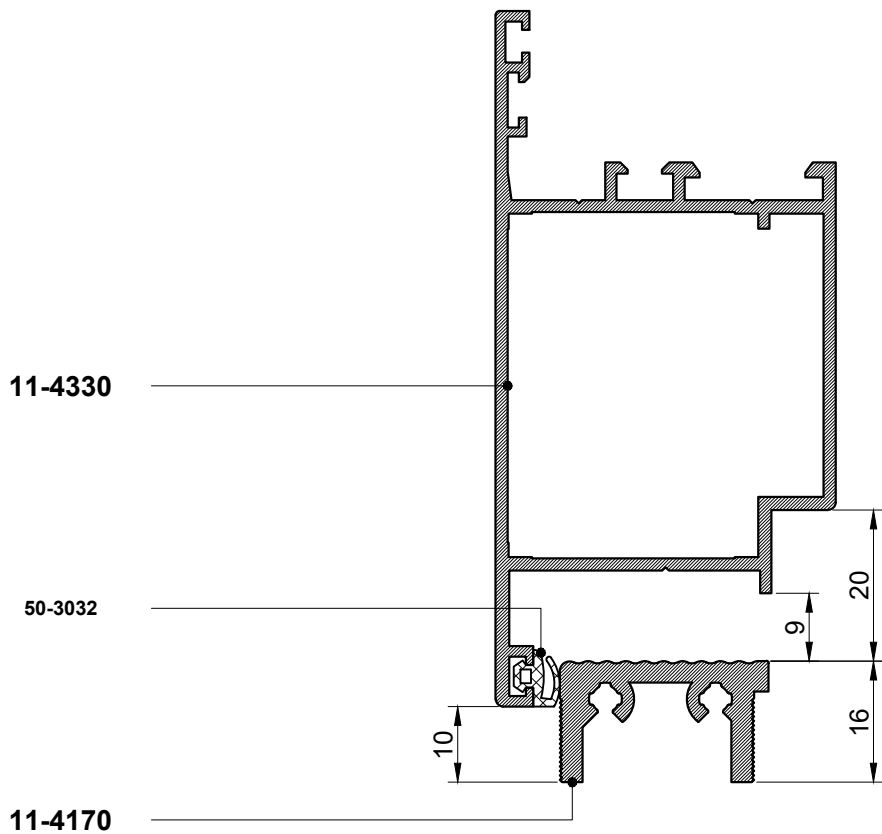
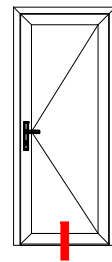

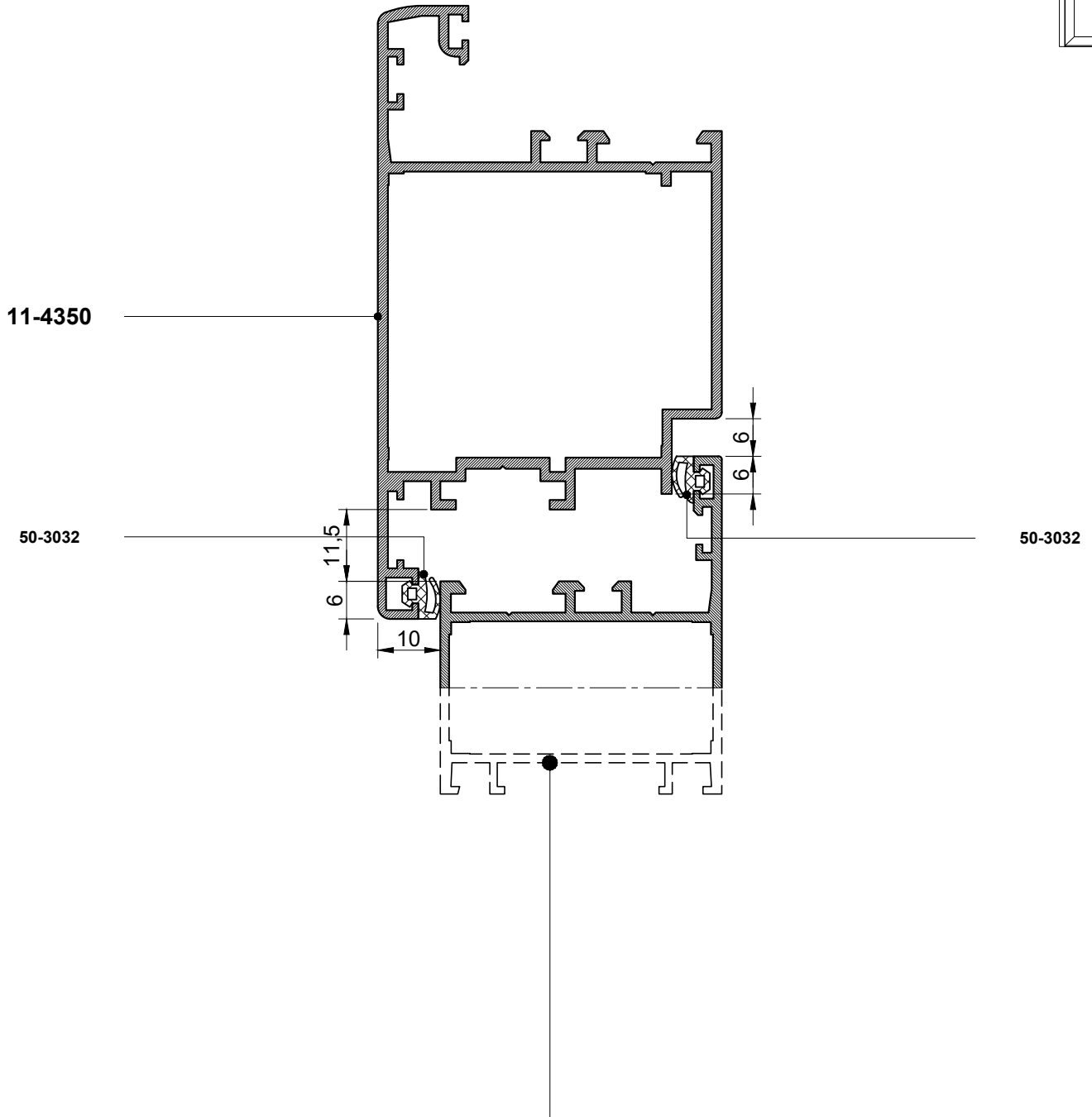
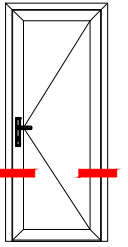

11-4110

11-4130

11-4131

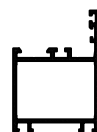
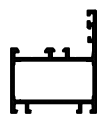
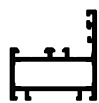

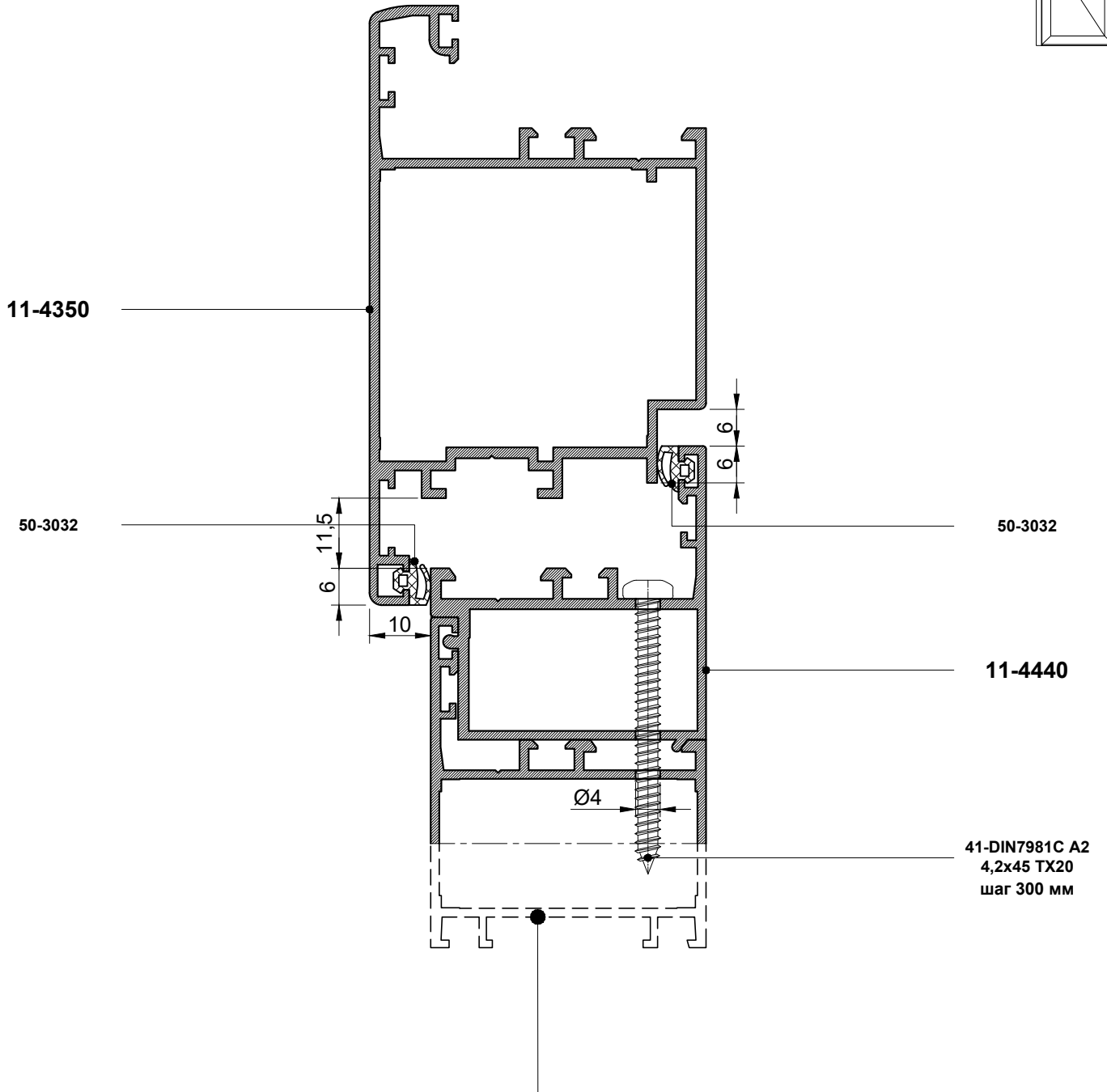
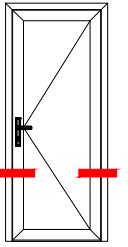

11-4110 11-4130 11-4131

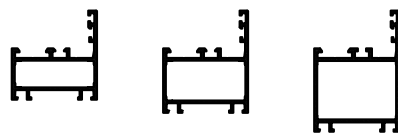

11-4210

11-4211

11-4340

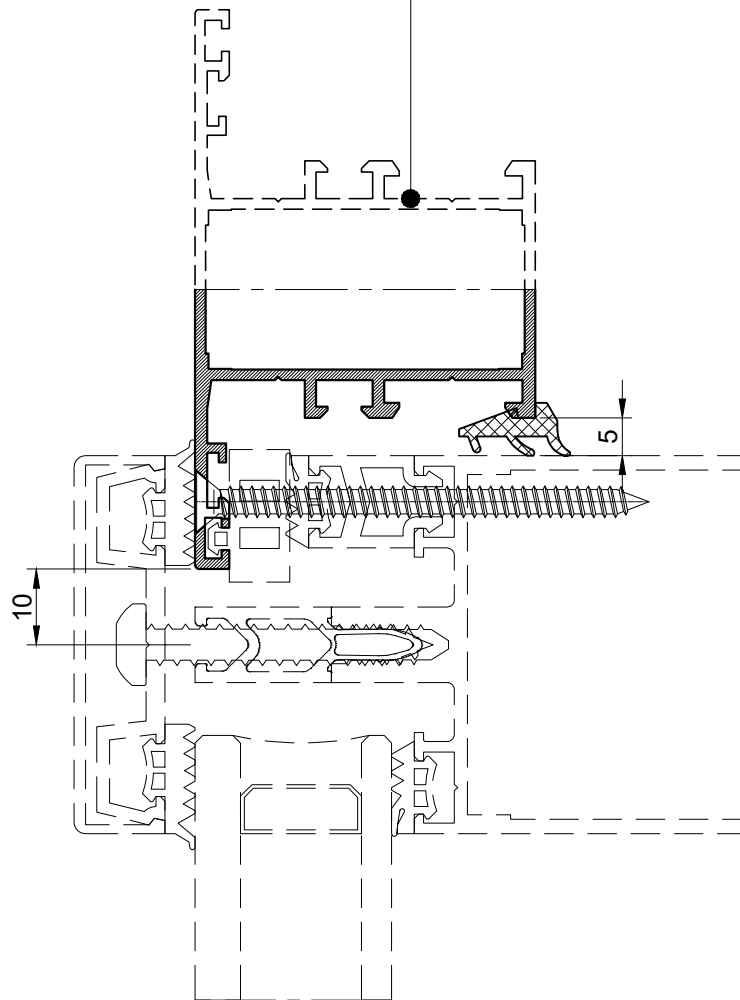
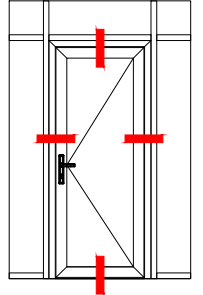
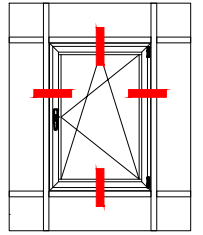
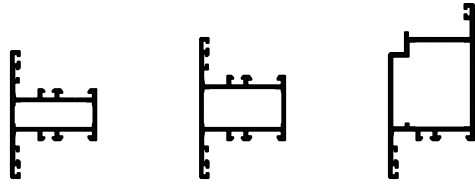

Смотри каталог F50



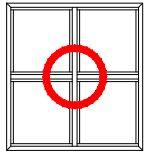

11-4210
11-4211

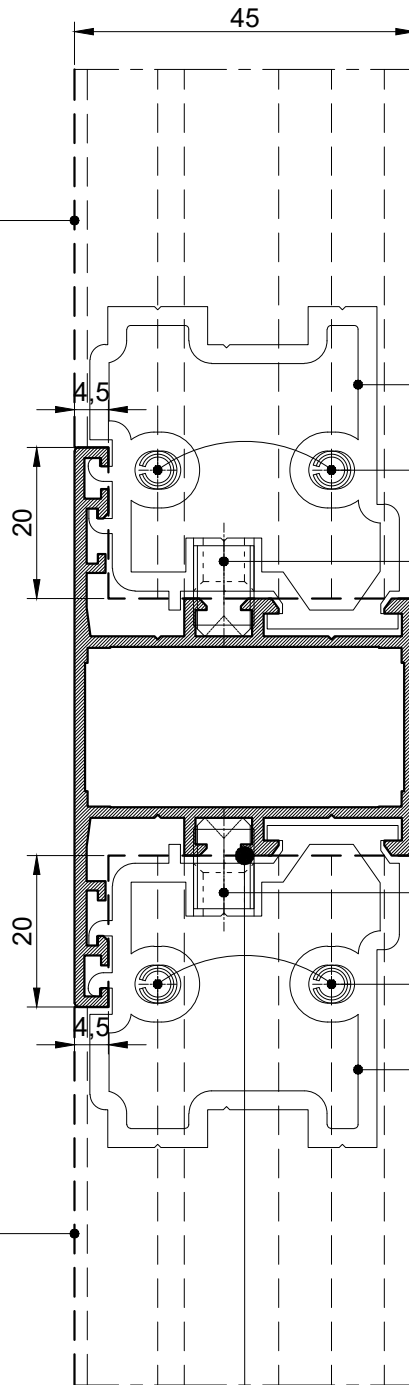

20-1400/0137
20-1400/0207

40-DIN1481 A2
D5x12
Штифт

40-DIN916 A2
M8x12 HEX4
Винт установочный с кантом

40-DIN916 A2
M8x12 HEX4

Винт установочный с кантом

40-DIN1481 A2
D5x12
Штифт

20-1400/0137
20-1400/0207

11-4210
11-4211

11-4210

11-4211

11-4220

11-4221

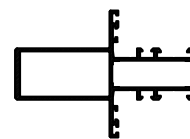
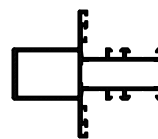
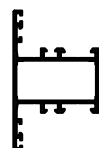
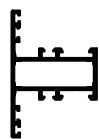

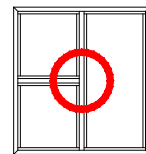

11-4210
11-4211

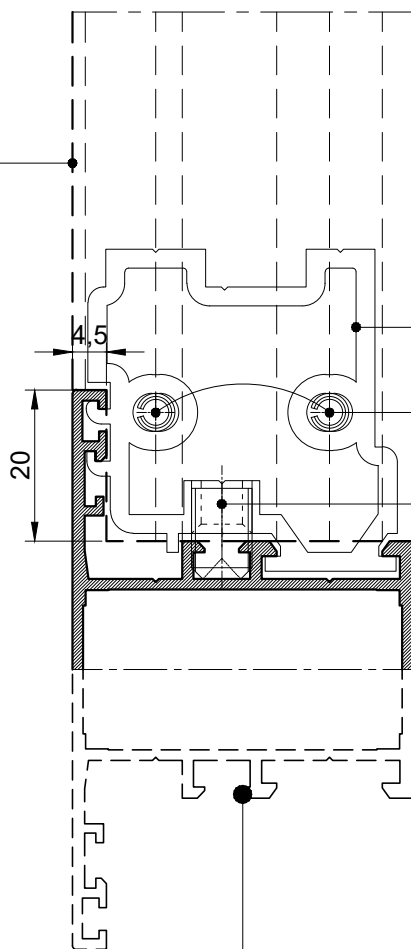

20-1400/0137
20-1400/0207

40-DIN1481 A2
D5x12
Штифт

40-DIN916 A2
M8x12 HEX4
Винт установочный с кантом

11-4110

11-4130

11-4131

11-4210

11-4211

11-4220

11-4221

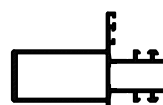
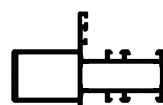
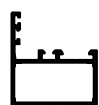
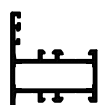
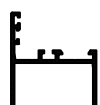
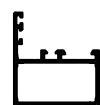
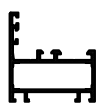

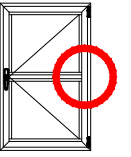

11-4230
Импост 74 мм
в створку

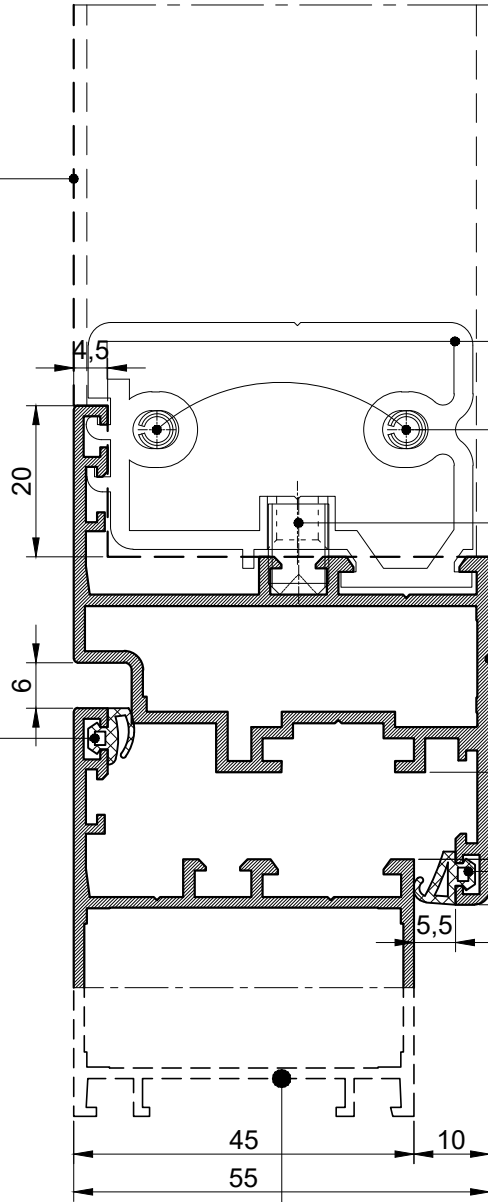

20-1500/0207

40-DIN1481 A2
D5x12
Штифт

40-DIN916 A2
M8x12 HEX4
Винт установочный с кантом

11-4310
11-4320

50-3032

50-3055

11-4110

11-4130

11-4131

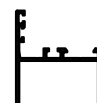
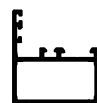
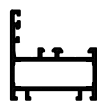

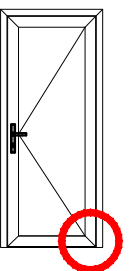
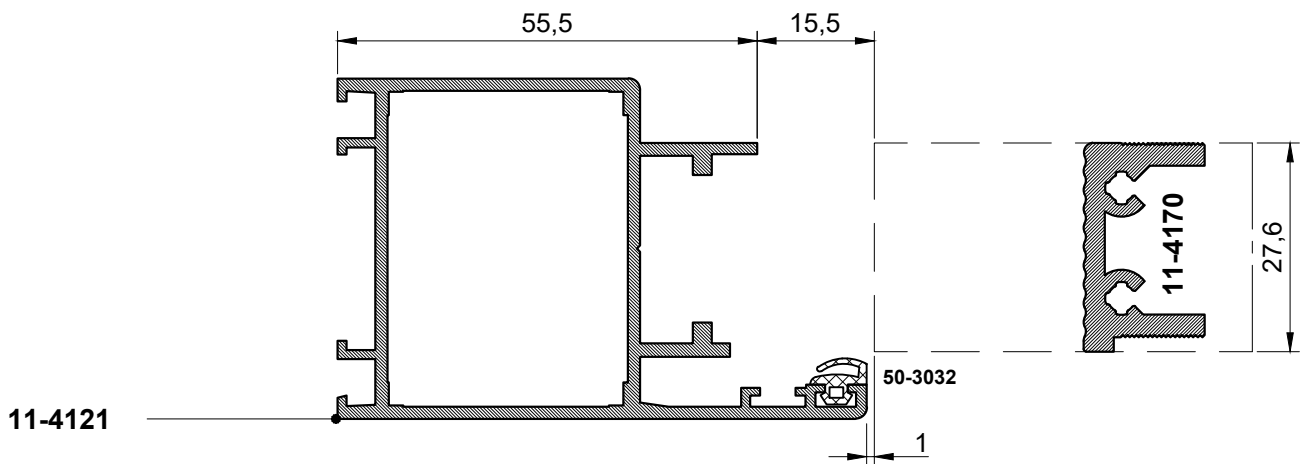
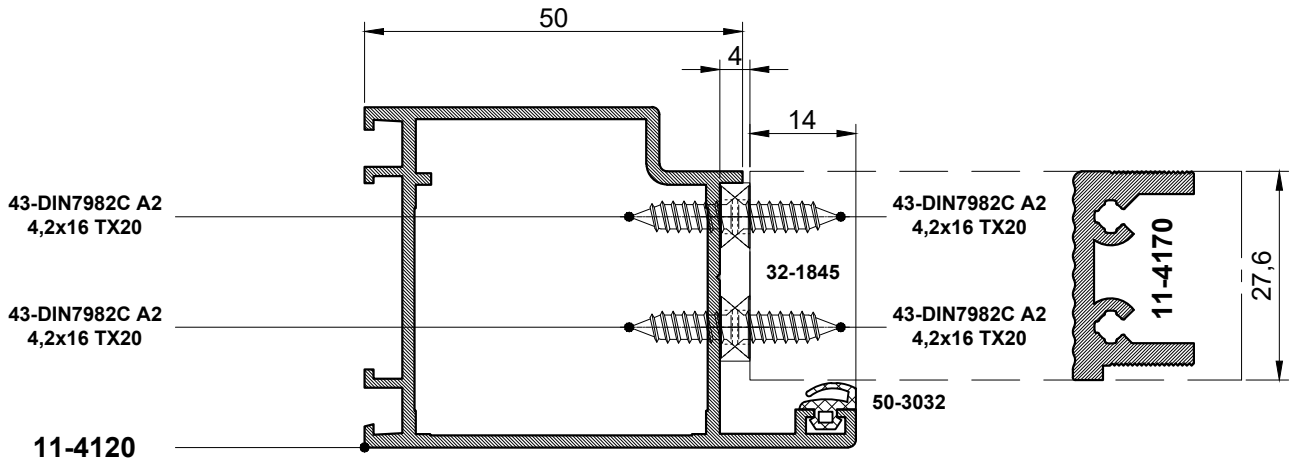

11-4110

11-4130

11-4131

11-4210

11-4211

11-4220

11-4221

11-4222

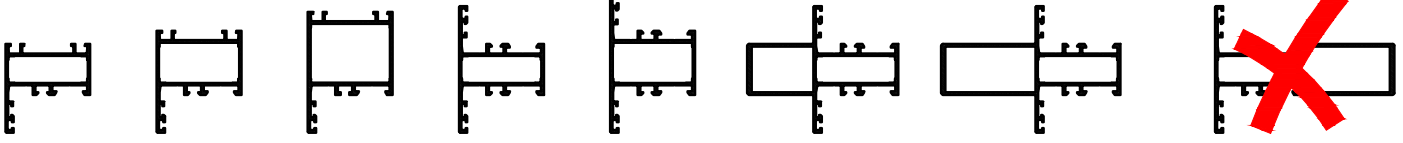

50-3032

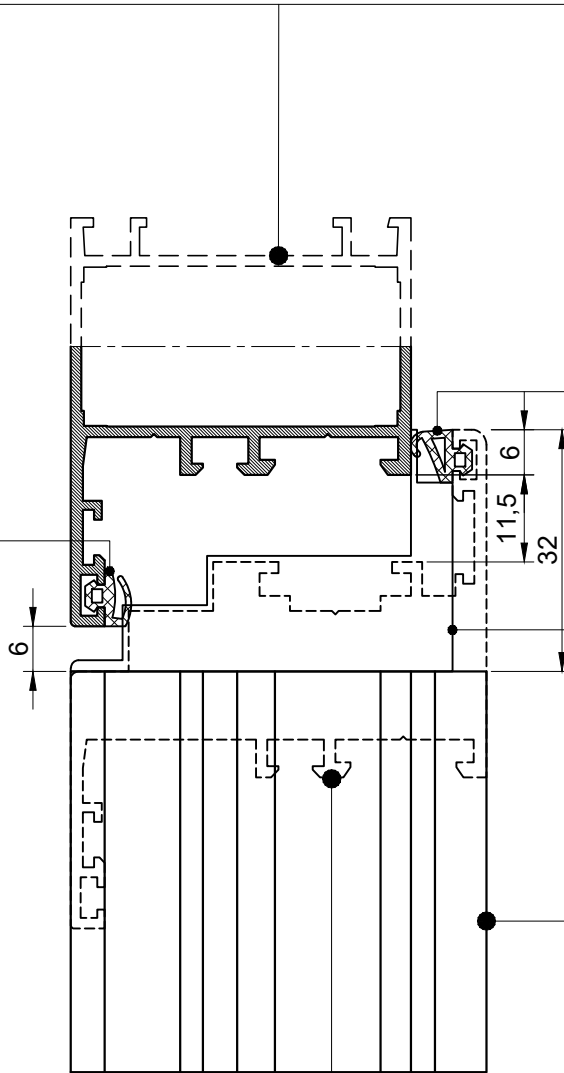

50-3055

33-2045

11-4410

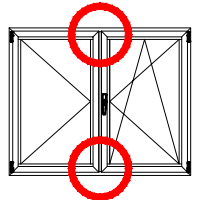

11-4310

11-4320

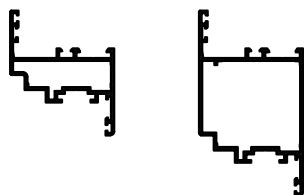

11-4330

11-4340

11-4120

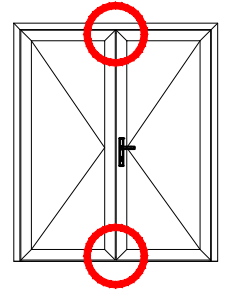
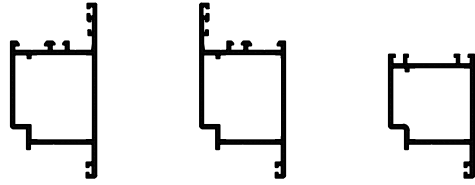

33-1945

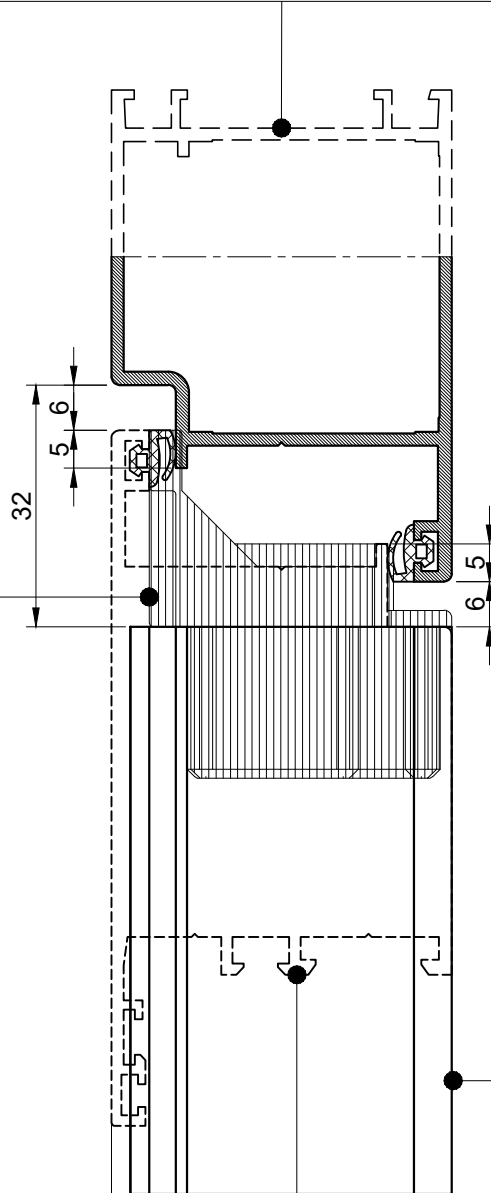

11-4420

11-4330

11-4340

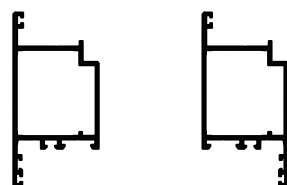

11-4330

11-4340

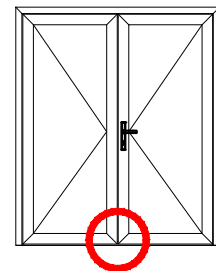
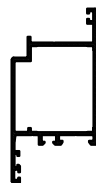
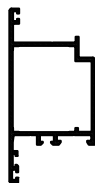

11-4420

33-1945

36

10

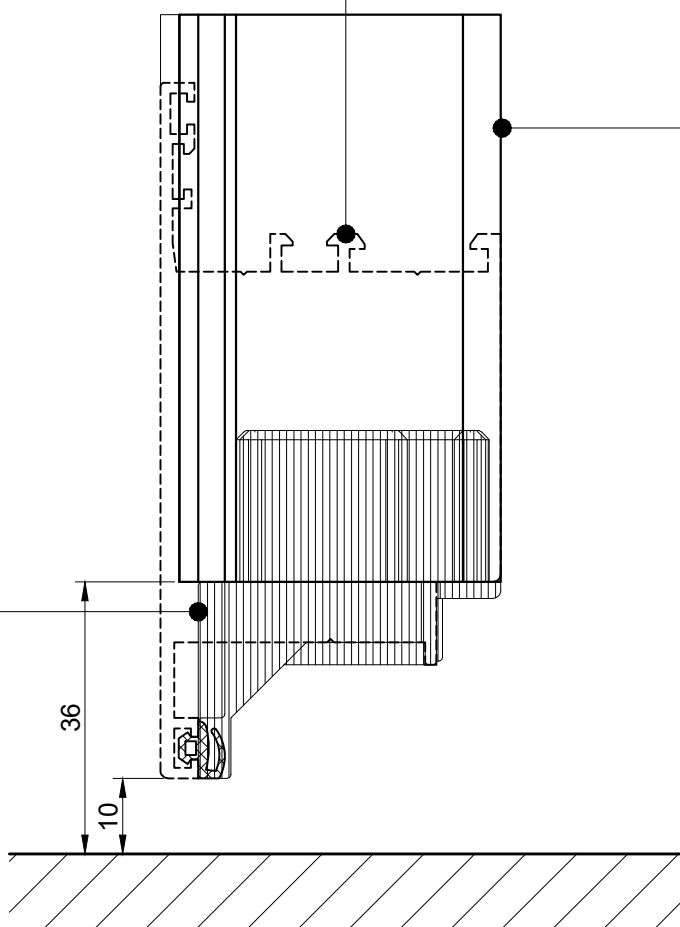

11-4330

11-4340

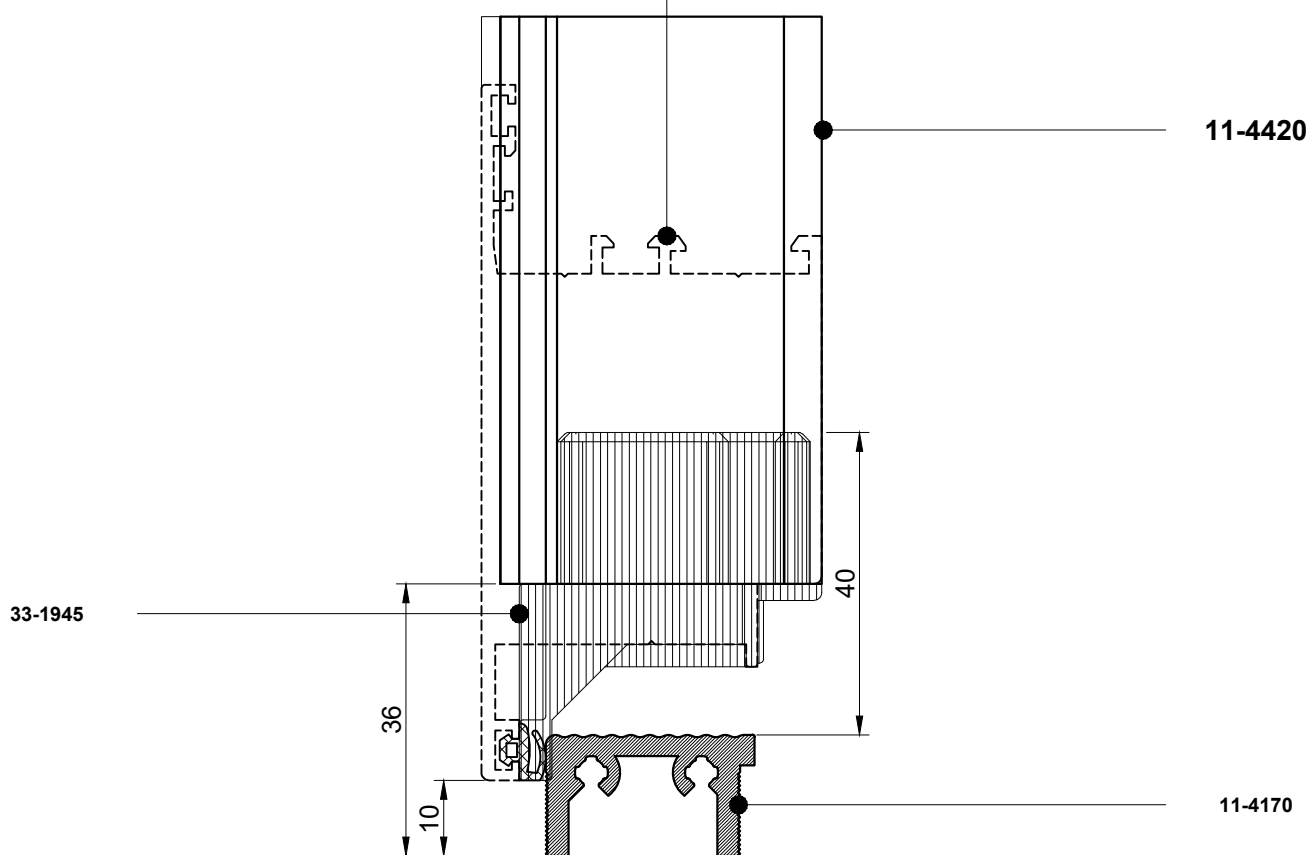
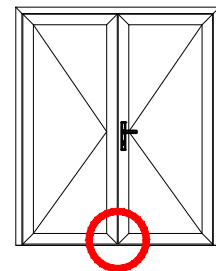
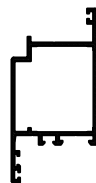
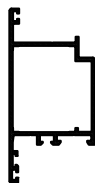

Толщина заполнения, А мм	Профили 45 мм		Профили 55 мм		Уплотнитель	
	Штапик высотой 20 мм		Штапик высотой 20 мм		Уплотнитель	
	Артикул	X1, мм	Артикул	X2, мм	Артикул	S, мм
4	10-6260	26,5	10-6360	36,5	50-1271	7
6					50-1251	5
8	10-6220	22,5	10-6320	32,5	50-1271	7
10					50-1251	5
12	10-6160	16,5	10-6260	26,5	50-1291	9
14					50-1271	7
16					50-1251	5
18					50-1271	7
20	10-6120	12,5	10-6220	22,5	50-1251	5
22					50-1291	9
24	10-6060	6,5	10-6160	16,5	50-1271	7
26					50-1251	5

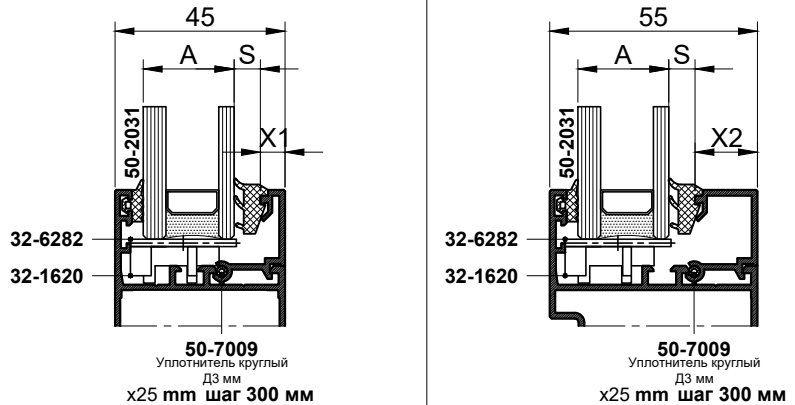
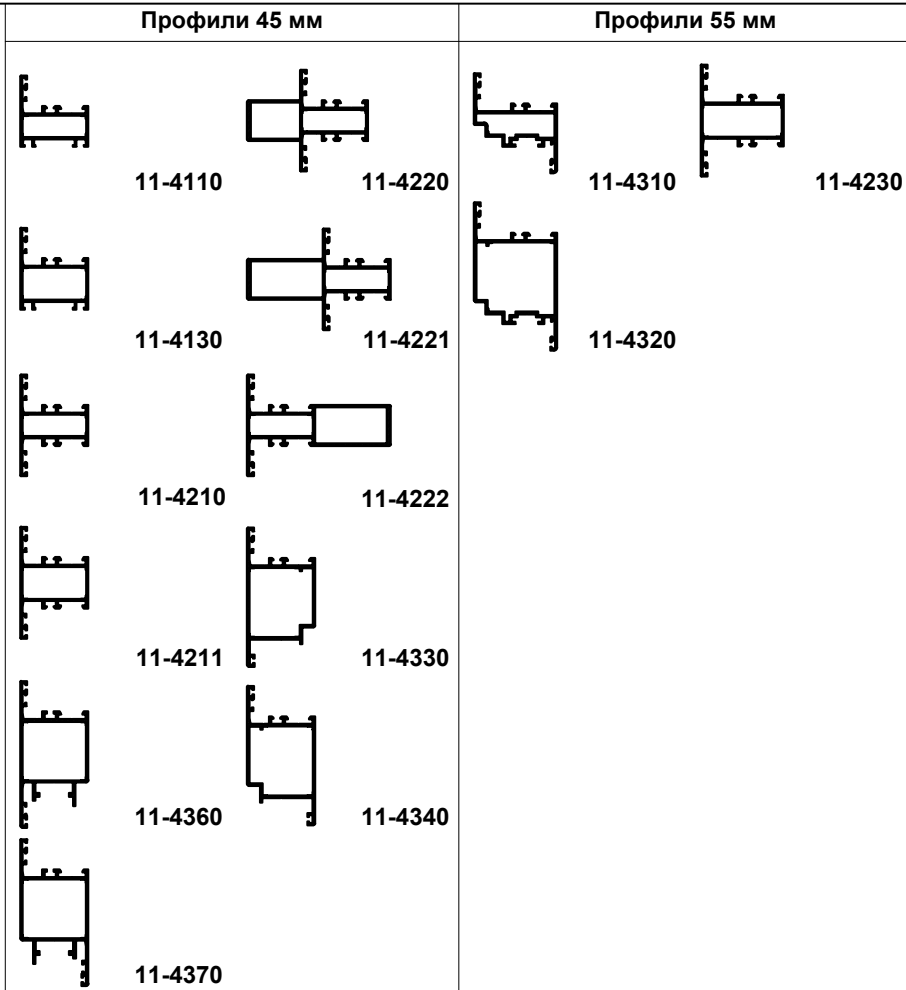

Толщина заполнения, А мм	Штапик высотой 20 мм			Уплотнитель		
	Артикул	X1, mm		Артикул	S, mm	
4	10-6260	26,5		50-1271	7	
6					50-1251	5
8	10-6220	22,5		50-1271	7	
10					50-1251	5
12	10-6160	16,5		50-1291	9	
14					50-1271	7
16					50-1251	5
18	10-6120	12,5		50-1271	7	
20					50-1251	5
22	10-6060	6,5		50-1291	9	
24					50-1271	7
26					50-1251	5



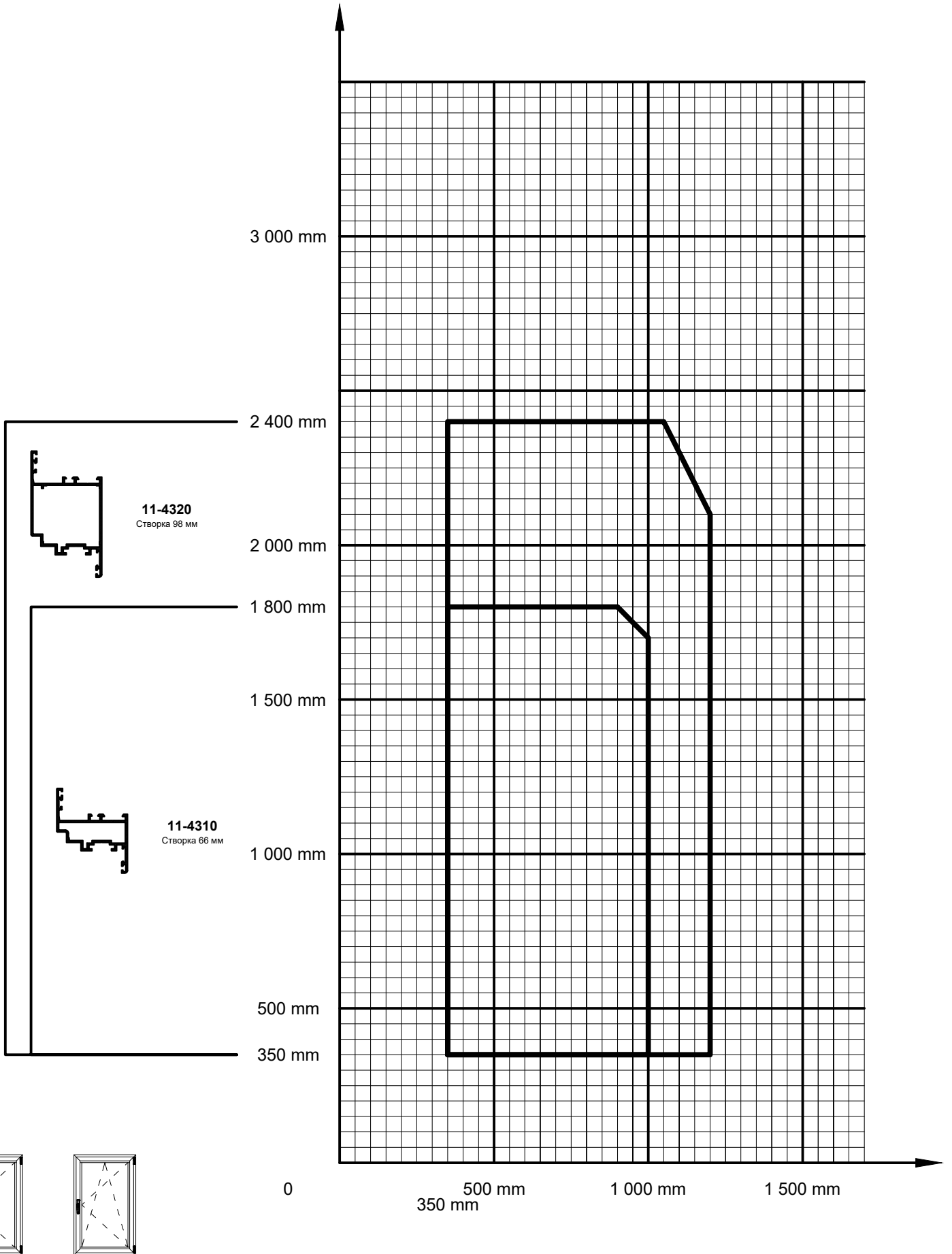

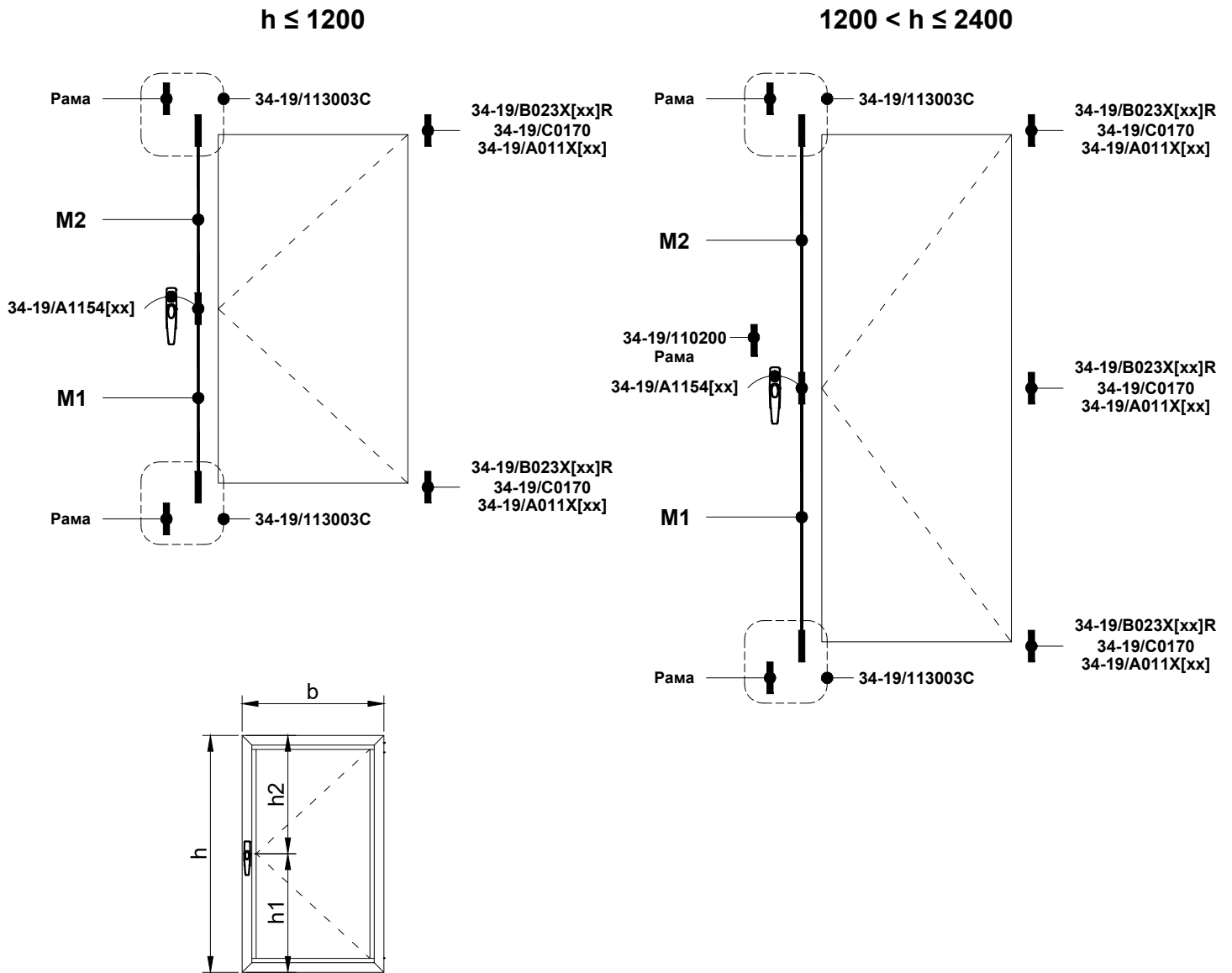

Мувиль	Длина, мм
M1	h1 - 82
M2	h2 - 190

Вес створки, кг	Навес	Ручка	Запорная часть		Ограничения	
			$h \leq 1200$	$1200 < h \leq 2400$	Ширина	Высота
≤ 50	34-19/B023X[xx]R	34-19/A1154[xx]	34-19/113003C x2	34-19/113003C x2 34-19/110200	см. диаграмму	
≤ 60	34-19/C0170					
≤ 90	34-19/A011X[xx]					



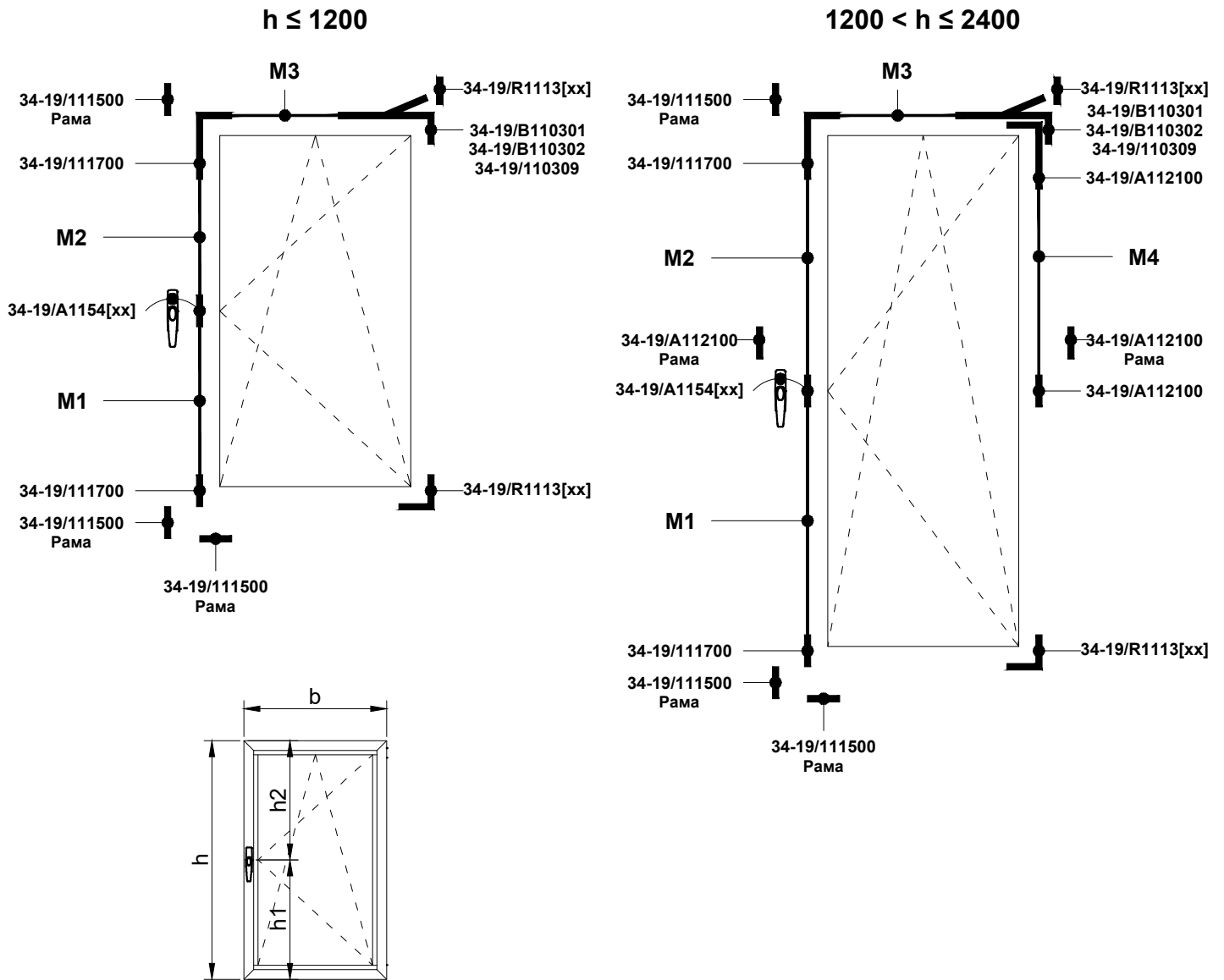

Мувиљ	Артикул	Длина, мм
M1		h1 - 82
M2		h2 - 190
M3	34-19/B110301	b - 495
	34-19/B110302	b - 373
	34-19/110309	b - 309
M4		h/2 - 205

Высота (h), мм	Ширина (b), мм			Ручка
	350 ≤ b ≤ 450	450 < b ≤ 750	750 < b ≤ 1200	
h ≤ 1200	34-19/110309 x1 34-19/111700 x1 34-19/111500 x1 34-19/R1113[xx] x1	34-19/B110302 x1 34-19/111700 x1 34-19/111500 x1 34-19/R1113[xx] x1	34-19/B110301 x1 34-19/111700 x1 34-19/111500 x1 34-19/R1113[xx] x1	34-19/A1154[xx]
1200 < h ≤ 2400	34-19/110309 x1 34-19/111700 x1 34-19/111500 x1 34-19/R1113[xx] x1 34-19/A112100 x1	34-19/B110302 x1 34-19/111700 x1 34-19/111500 x1 34-19/R1113[xx] x1 34-19/A112100 x1	34-19/B110301 x1 34-19/111700 x1 34-19/111500 x1 34-19/R1113[xx] x1 34-19/A112100 x1	



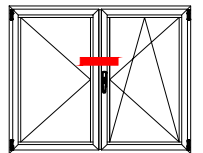
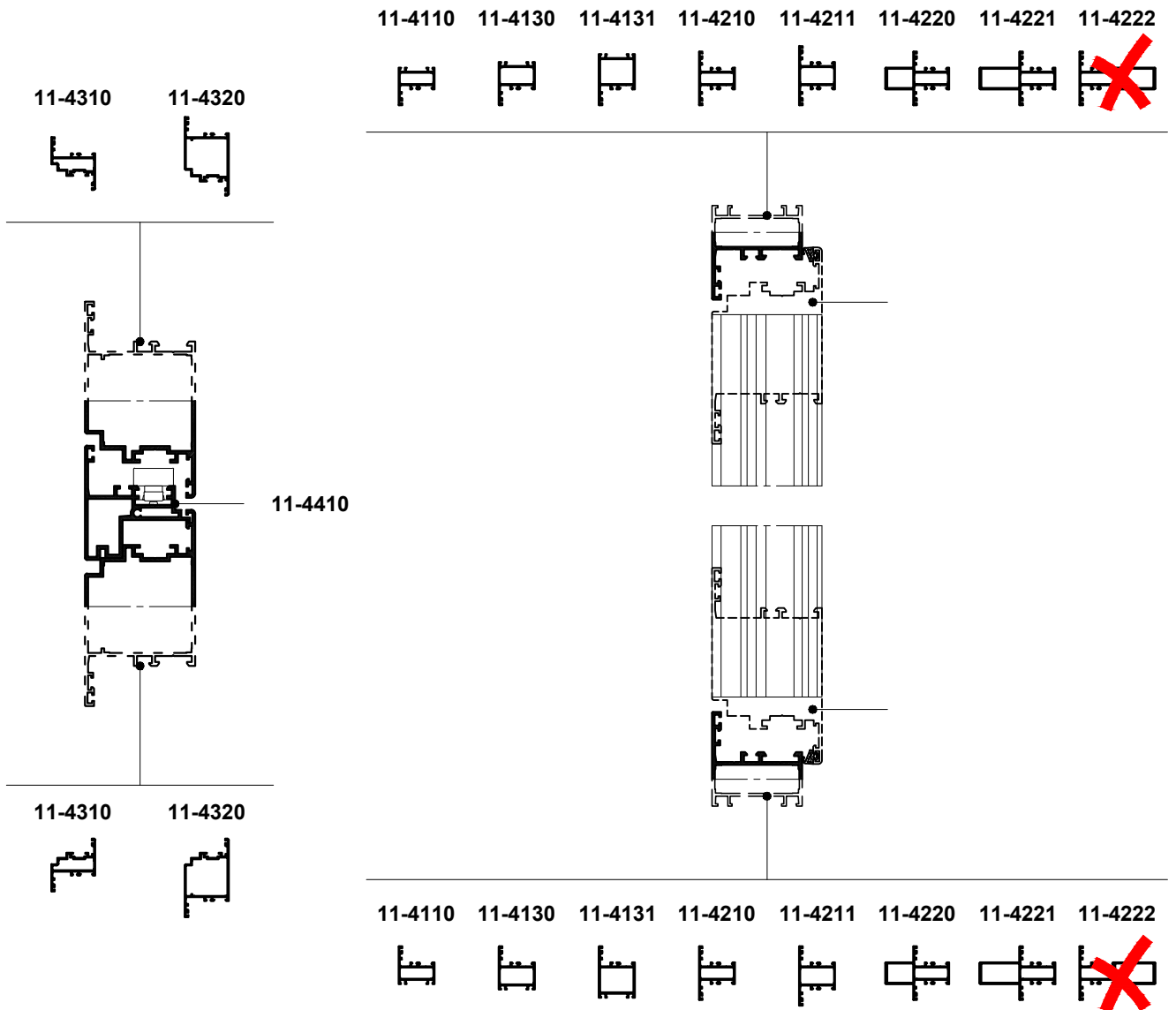

Шпингалет				Планка ответная			Примыкающий элемент
Внешний вид	Артикул	Наименование	Крепление	Внешний вид	Артикул	Крепление	Артикул
	34-19/111601	Комплект шпингалетов шульповых	В комплекте			В комплекте	11-4110 11-4130 11-4131 11-4210 11-4211 11-4220 11-4221 11-4222



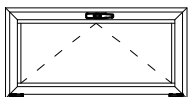
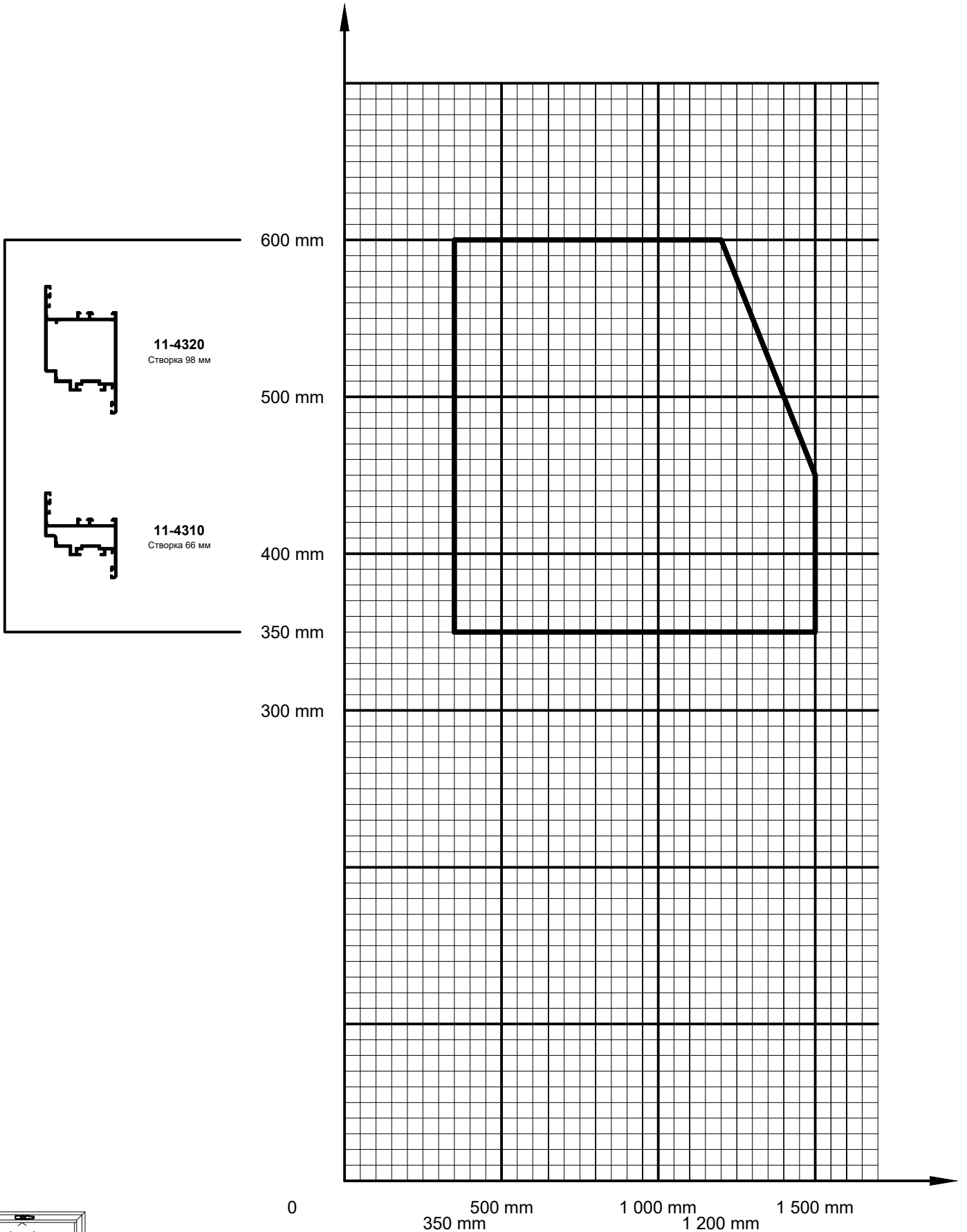

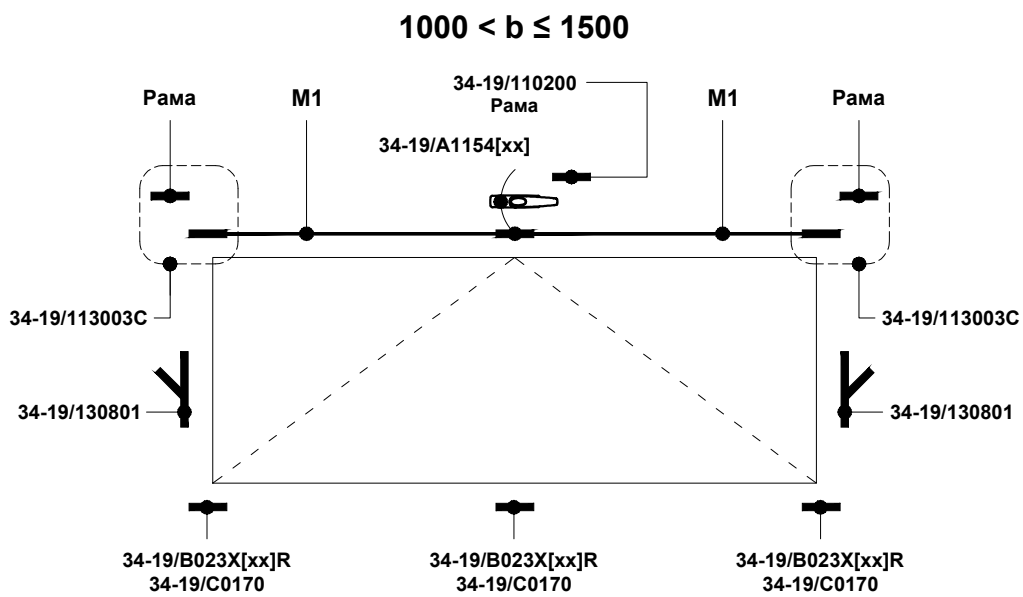
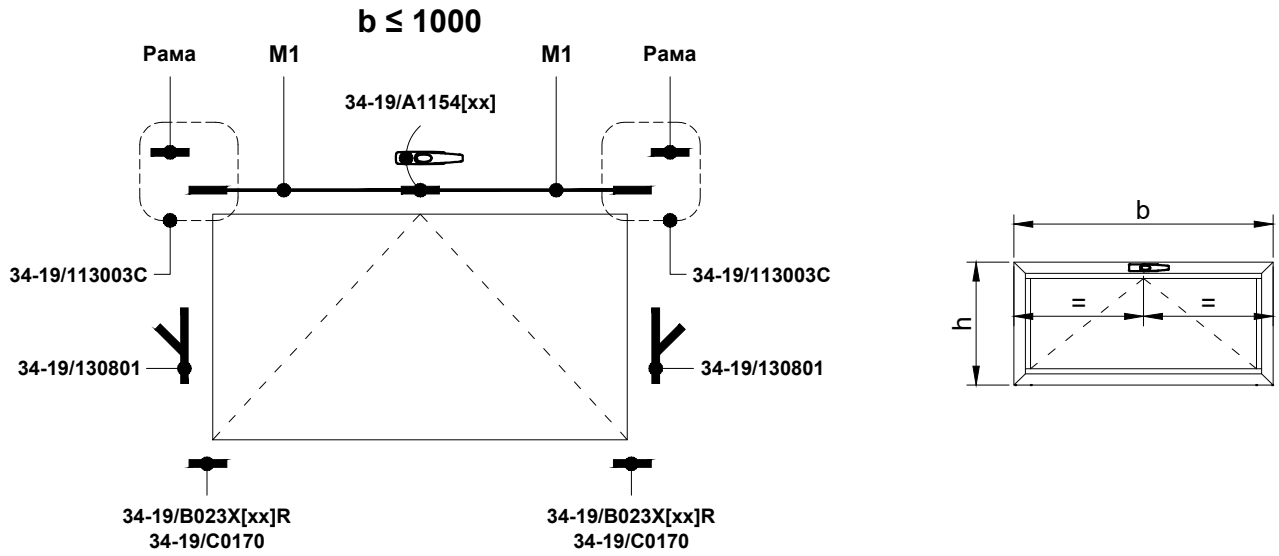

Мувиль	Длина, мм
M1	$h/2 - 205$

Вес створки, кг	Навес	Ограничитель открывания	Ручка	Запорная часть		Ограничения	
				$b \leq 1000$	$1000 < b \leq 1500$	Ширина	Высота
≤ 15	34-19/B023X[xx]R	34-19/130801 x2	34-19/A1154[xx]	34-19/113003C x2	34-19/113003C x2	см. диаграмму	
≤ 30	34-19/C0170						



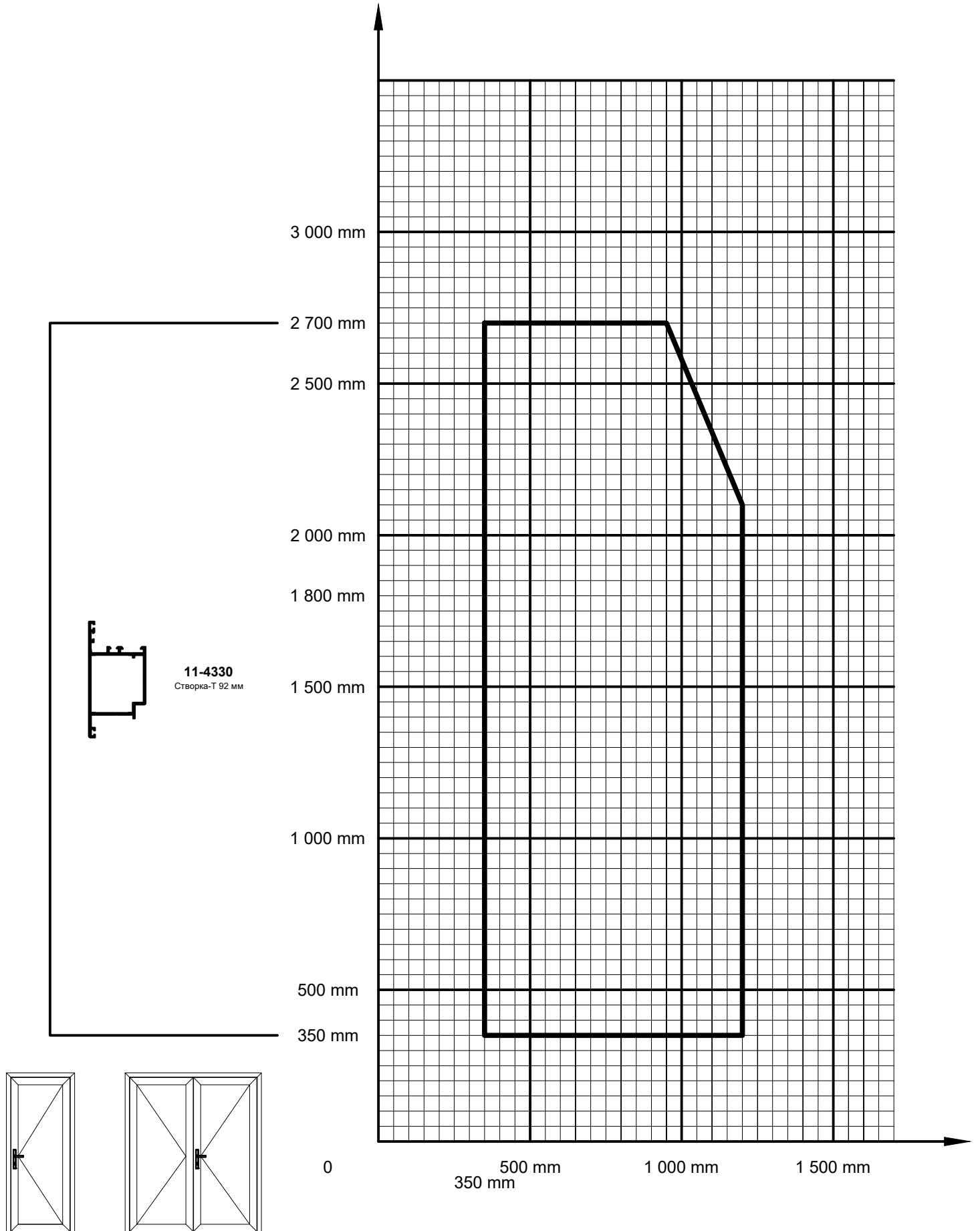

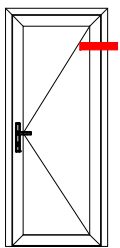
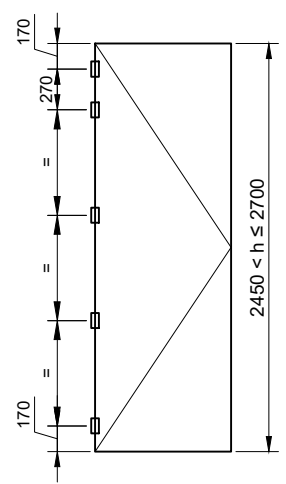
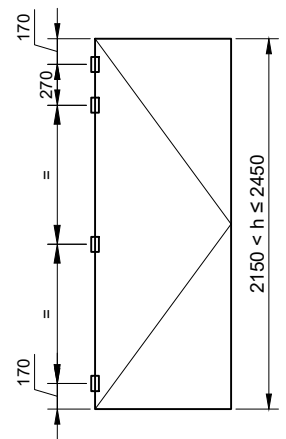
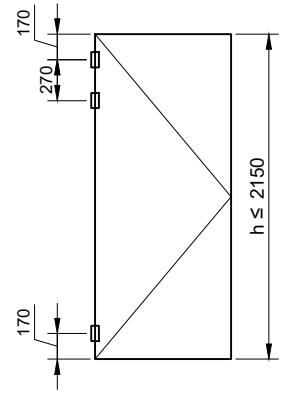
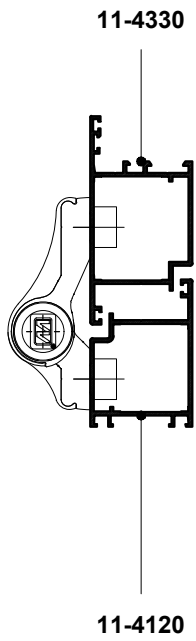

Навес			Крепление		
Внешний вид	Артикул	Наименование	Внешний вид	Артикул	Наименование
	34-20/MX8010456	Навес двухчастный WLINE-MX			
	34-20/WX8010456	Навес двухчастный WLINE-WX			
	34-25/M701<x>E000	Навес дверной Dr. Hahn			



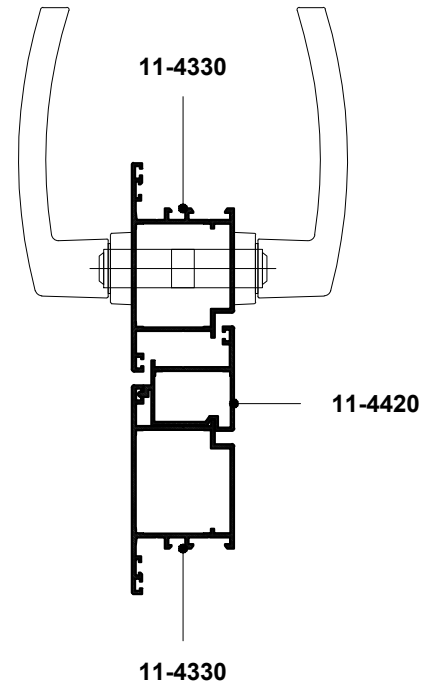
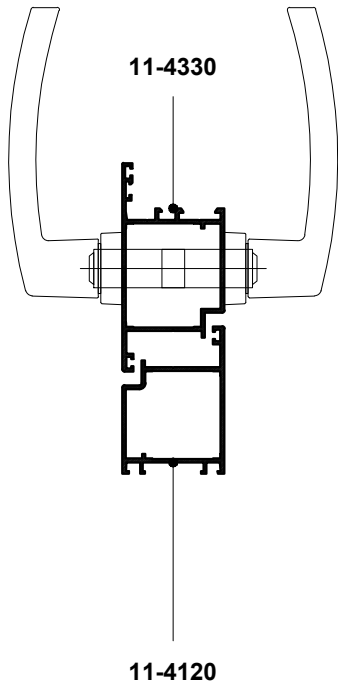

34-02/1615-03

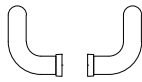

34-02/0206.350

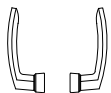

34-19/05182

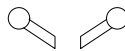

34-20/WUP0000001059

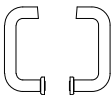

34-04/0000008030093

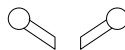

34-20/WUP0000001067

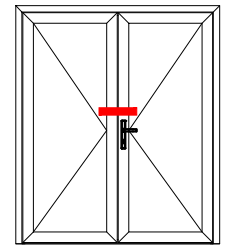
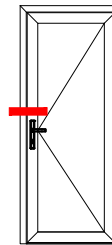

Ручка				Накладка			Цилиндр фигурный
Внешний вид	Артикул	Наименование	Крепление	Внешний вид	Артикул	Крепление	Артикул
	34-02/1615-03	Гарнитур нажимной 32/92/66-75	46-DIN966 A2 M5x70 TX25 x3	-	-	-	34-01/0003/3535
	34-19/05182	Комплект ручек нажимных POLARIS	46-DIN965 Zn M5x16 TX25 x8 40-ART1021 A2 M5x11,5 x8		34-19/0508053[xx] x2	41-DIN7981C A2 3,5x6,5 TX10 x4	34-01/0003/3030
	34-04/0000008030093	Комплект ручек нажимных с накладками	В комплекте	В комплекте	В комплекте	В комплекте	34-01/0003/3535
	34-02/0206.350	Комплект ручек дверных стационарных	В комплекте		34-19/0508053[xx] x2	41-DIN7981C A2 3,5x6,5 TX10 x4	34-01/0003/3030
	34-20/WUP0000001059	Комплект ручек 1200-1400 мм с креплением	В комплекте		34-23/0000417611	43-DIN7982C A2 3,9x13 TX15 x4	34-01/0003/3535
	34-20/WUP0000001067	Комплект ручек 300-500 мм с креплением	В комплекте		34-23/0000417611	43-DIN7982C A2 3,9x13 TX15 x4	34-01/0003/3535



11-4330

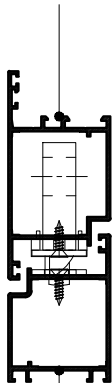

11-4120

11-4330

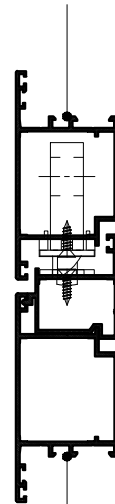

11-4420

11-4330

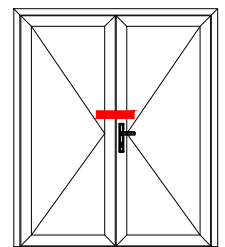
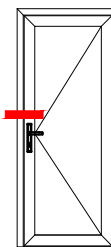

Ручка	Замок				Планка ответная		
	Внешний вид	Артикул	Наименование	Крепление	Внешний вид	Артикул	Крепление
Нажимные 34-02/1615-03 Гарнитура нажимной 32/92/66-75 34-19/05182 Комплект ручек нажимных POLARIS 34-04/0000008030093 Комплект ручек нажимных с накладками		34-22/3469528	Замок клиновидный KFV RES 49N 24x6/92/35	43-DIN7982C A2 3,9x16 TX15 x2		34-22/3477532 лев 34-22/3477533 прав	34-18/239298 43-DIN7982C A2 3,9x16 TX15 x3
		34-04/1100000009810	Замок клиновидный 24x3/92/35	34-04/1100000009939 43-DIN7982C A2 3,9x16 TX15 x2	-	В комплекте	34-18/239298 43-DIN7982C A2 3,9x16 TX15 x3
		34-22/3488093	Замок МЗК KFV AS2300 24x6x1880-2170/35/92	43-DIN7982C A2 3,9x16 TX15 x10		34-22/3478553 лев 34-22/3478552 прав	34-18/239298 43-DIN7982C A2 3,9x16 TX15 x10
		34-22/3492892	Замок МЗК KFV AS2750 24x6x1880-2170/35/92	43-DIN7982C A2 3,9x16 TX15 x10		34-22/3478553 лев 34-22/3478552 прав	34-18/239298 43-DIN7982C A2 3,9x16 TX15 x10
Стационарные 34-02/0206.350 Комплект ручек дверных стационарных 34-20/WUP0000001059 Комплект ручек 1200-1400 мм с креплением 34-20/WUP0000001067 Комплект ручек 300-500 мм с креплением		34-22/3469528	Замок клиновидный KFV RES 49N 24x6/92/35	43-DIN7982C A2 3,9x16 TX15 x2		34-22/3477532 лев 34-22/3493198 34-22/3477533 прав 34-22/3493198	34-18/239298 43-DIN7982C A2 3,9x16 TX15 x3
		34-04/1100000009820	Замок роликовый 24x3/92/35	34-04/1100000009939 43-DIN7982C A2 3,9x16 TX15 x2	-	В комплекте	34-18/239298 43-DIN7982C A2 3,9x16 TX15 x3
		34-22/3488093	Замок МЗК KFV AS2300 24x6x1880-2170/35/92	43-DIN7982C A2 3,9x16 TX15 x10		34-22/3478553 лев 34-22/3493198 34-22/3478552 прав 34-22/3493198	34-18/239298 43-DIN7982C A2 3,9x16 TX15 x10



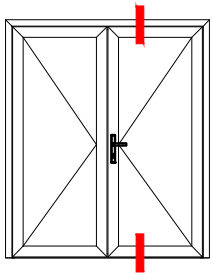
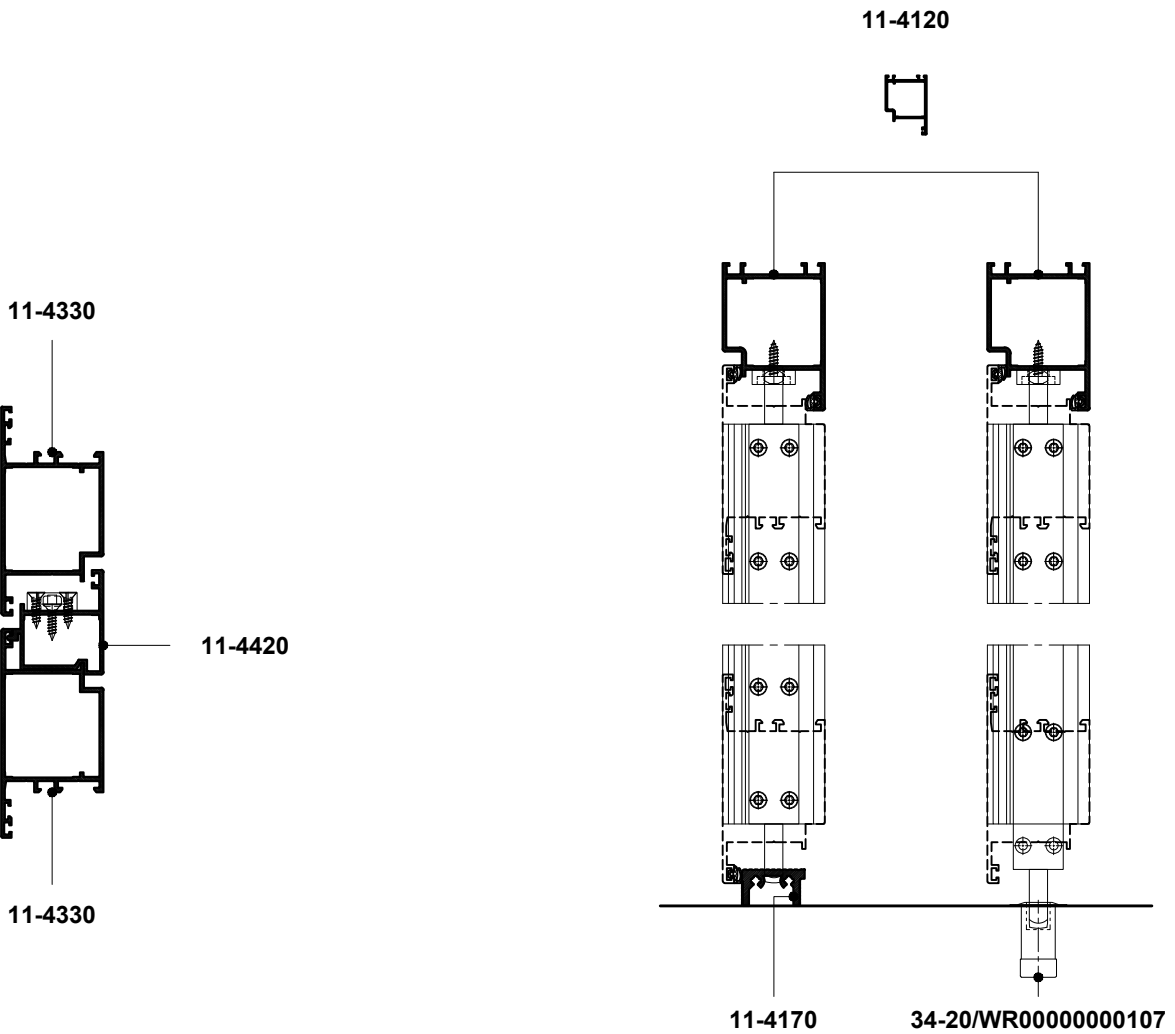

Шпингалет				Планка ответная			Примыкающий элемент
Внешний вид	Артикул	Наименование	Крепление	Внешний вид	Артикул	Крепление	Артикул
	34-21/8019005M2500H	Шпингалет 22x8x225	В комплекте		34-03/3012.20	В комплекте	11-4120
	34-21/8019005M2500H	Шпингалет 22x8x225	В комплекте	-	-	-	11-4170
	34-21/8019005M2500H	Шпингалет 22x8x225	В комплекте		34-20/WR00000000107	-	Пол



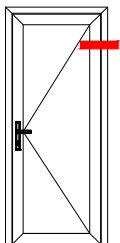
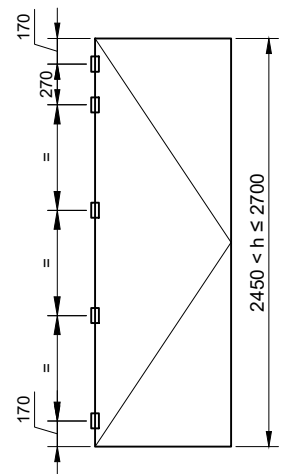
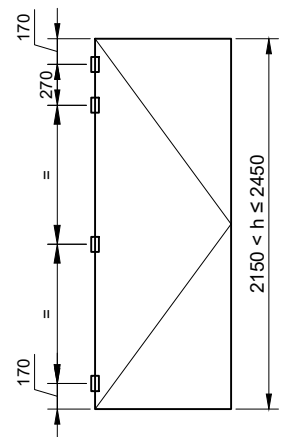
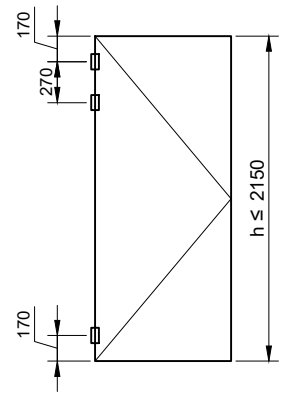
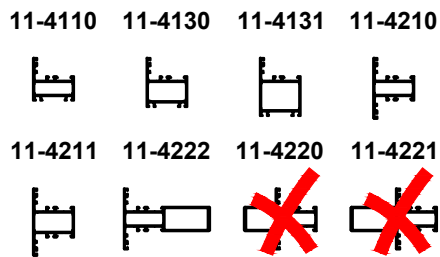
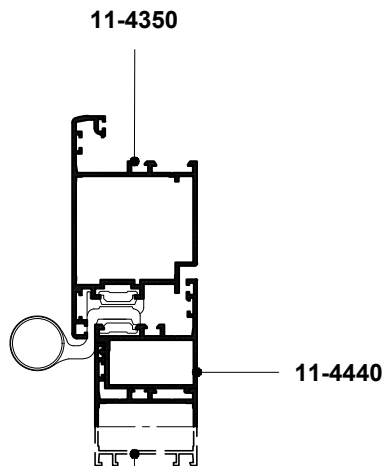
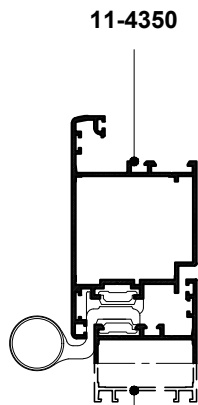

Навес			Крепление
Внешний вид	Артикул	Наименование	
	34-19/A011X[xx]	Навес двухчастный TAURUS	В комплекте
	34-20/RWE8010439	Навес дверной двухчастный WALA RWE	В комплекте



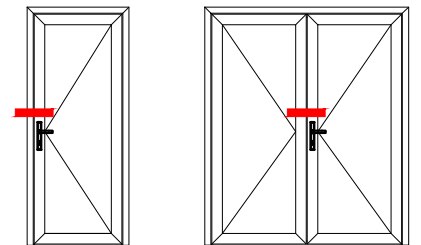
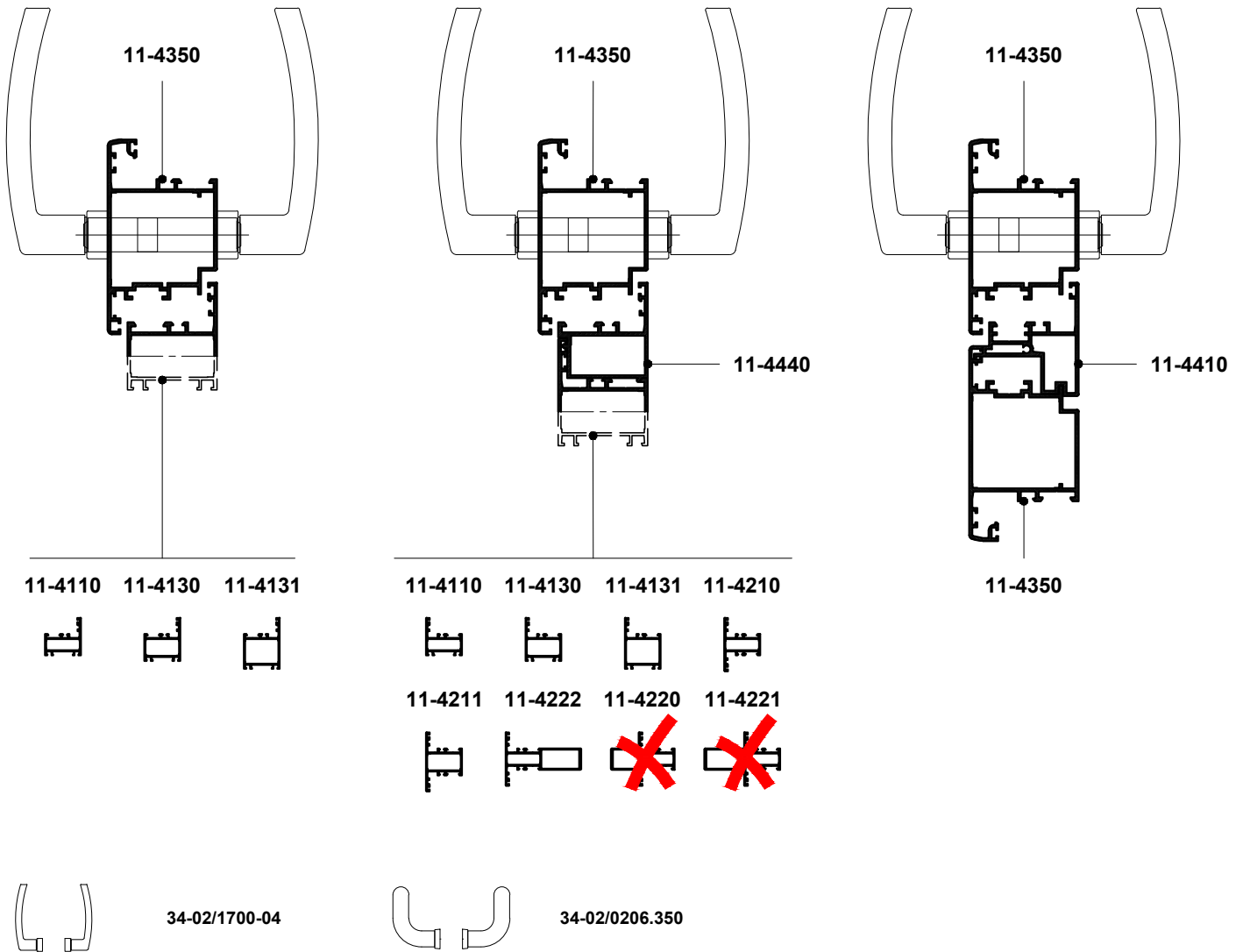

Ручка				Накладка			Цилиндр фигурный
Внешний вид	Артикул	Наименование	Крепление	Внешний вид	Артикул	Крепление	Артикул
	34-02/1700-04	Гарнитур нажимной 24/92/76-84	46-DIN966 A2 M5x80 TX25 x3	-	-	-	34-01/0003/3045
	34-02/0206.350	Комплект ручек дверных стационарных	В комплекте		34-14/00001474	43-DIN7982C A2 3,9x13 TX15 x4	34-01/0003/3045

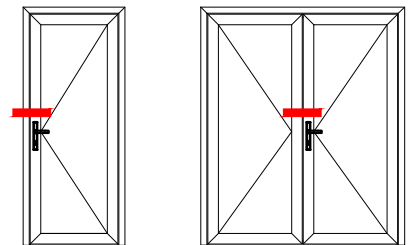
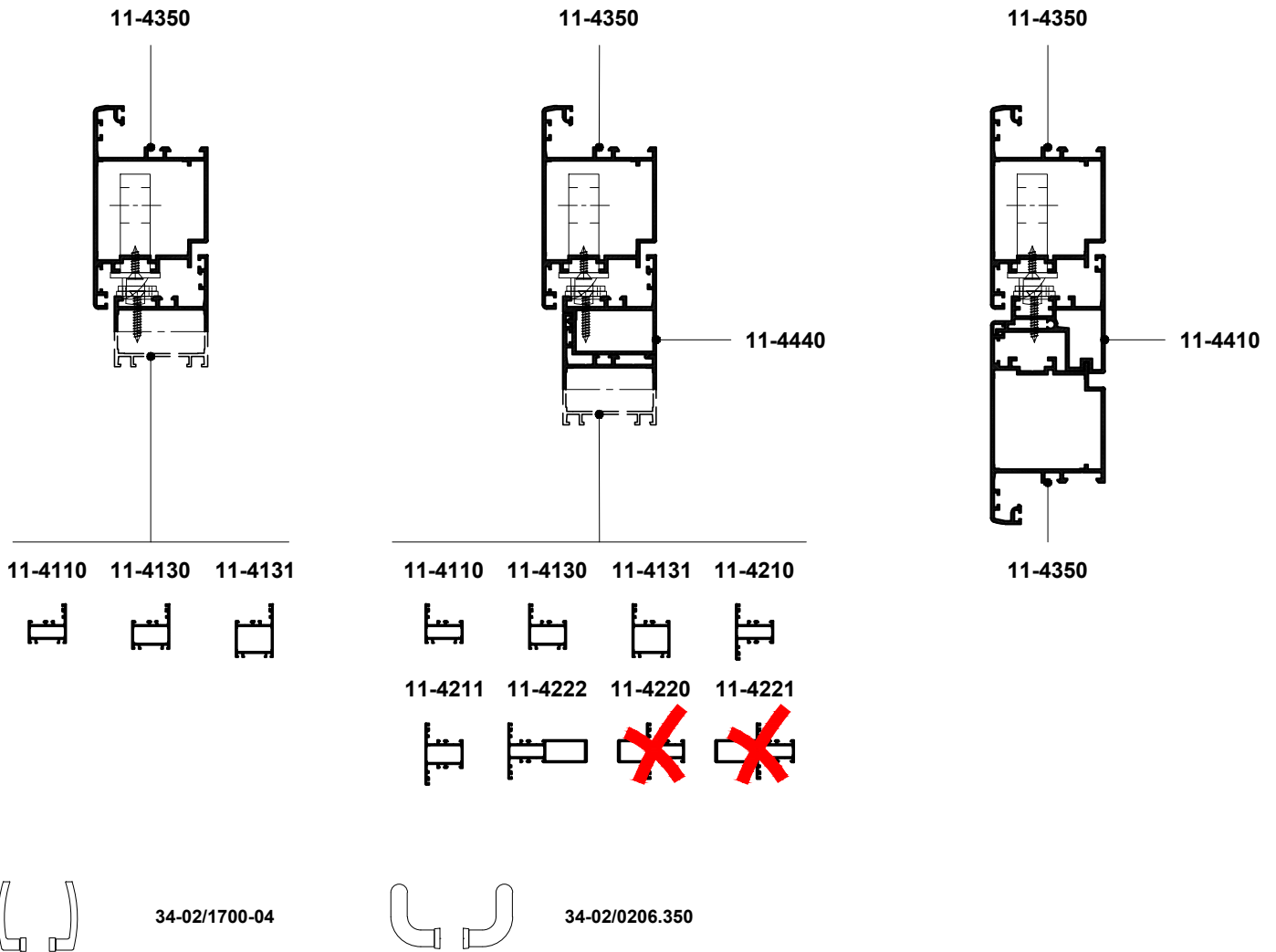

Замок				Планка ответная			Ручка
Внешний вид	Артикул	Наименование	Крепление	Внешний вид	Артикул	Крепление	
	34-04/110000009810	Замок клиновый 24x3/92/35	34-04/110000009939 43-DIN7982C A2 3,9x16 TX15 x2		34-16/СТ7777	43-DIN7982C A2 3,9x25 TX15 x3	34-02/1700-04 Гарнитур нажимной 24/92/76-84
	34-04/110000009820	Замок роликовый 24x3/92/35	34-04/110000009939 43-DIN7982C A2 3,9x16 TX15 x2		34-16/СТ7777	43-DIN7982C A2 3,9x25 TX15 x3	34-02/0206.350 Комплект ручек дверных стационарных



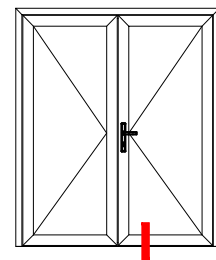
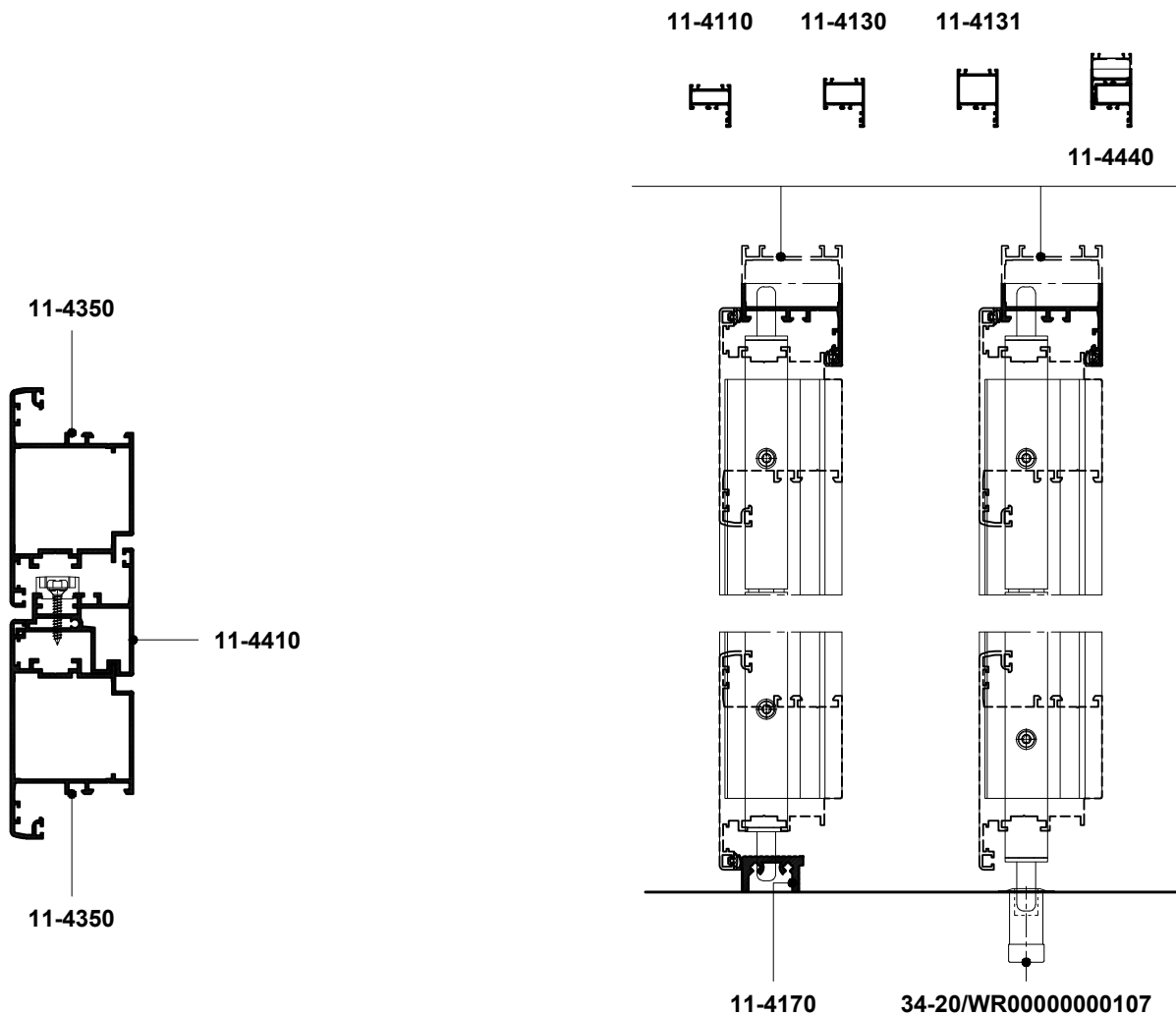

Шпингалет				Планка ответная			Примыкающий элемент
Внешний вид	Артикул	Наименование	Крепление	Внешний вид	Артикул	Крепление	Артикул
	34-19/052402[xx]	Шпингалет 19x8x220	В комплекте	-	-	-	11-4110 11-4130 11-4131 11-4170 11-4440
					34-20/WR00000000107	-	Пол



11-4310



11-4320

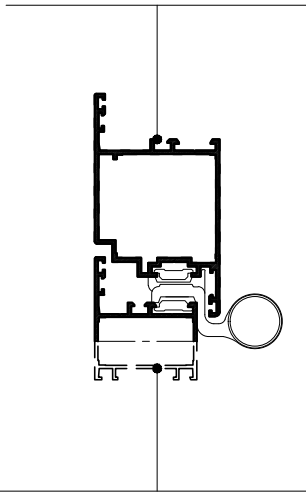

11-4110



11-4130



11-4131



11-4210



11-4211



11-4220



11-4221



11-4222

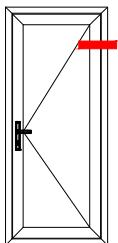
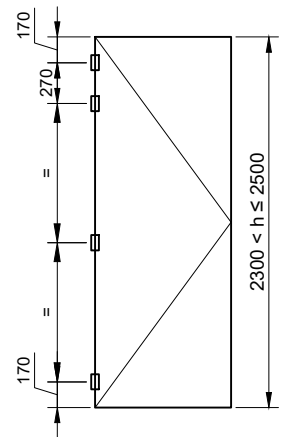
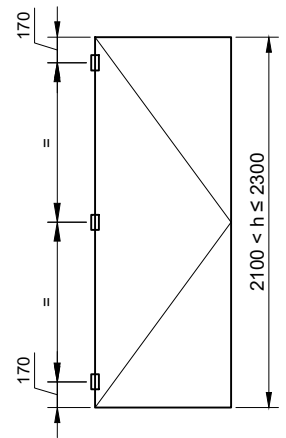
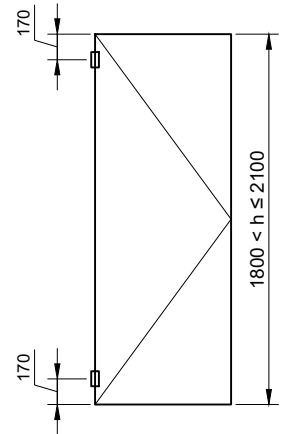

Навес			Ограничения		
Внешний вид	Артикул	Наименование	Ширина створки	Высота створки	Вес створки
	34-19/A011X[xx]	Навес двухчастный TAURUS	≤ 1200	≤ 2500	90 кг
	34-20/RWE8010439	Навес дверной двухчастный WALA RWE	≤ 1200	≤ 2500	90 кг



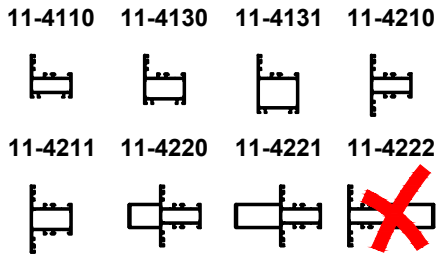
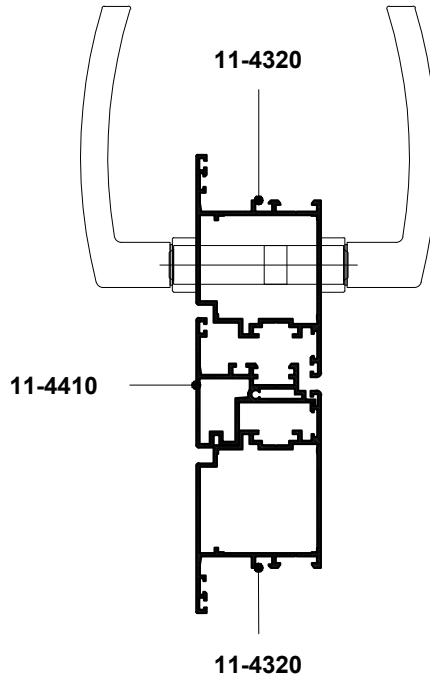
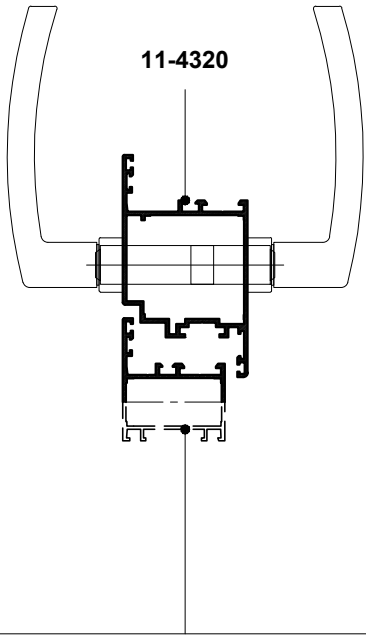

34-02/1700-04

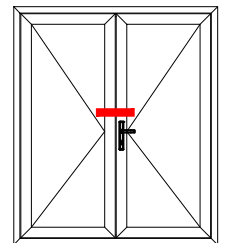
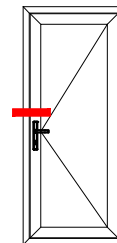

Ручка				Накладка			Цилиндр фигурный
Внешний вид	Артикул	Наименование	Крепление	Внешний вид	Артикул	Крепление	Артикул
	34-02/1700-04	Гарнитура нажимной 24/92/76-84	46-DIN966 A2 M5x80 TX25 x3	-	-	-	34-01/0003/3045



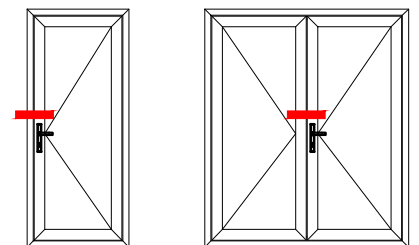
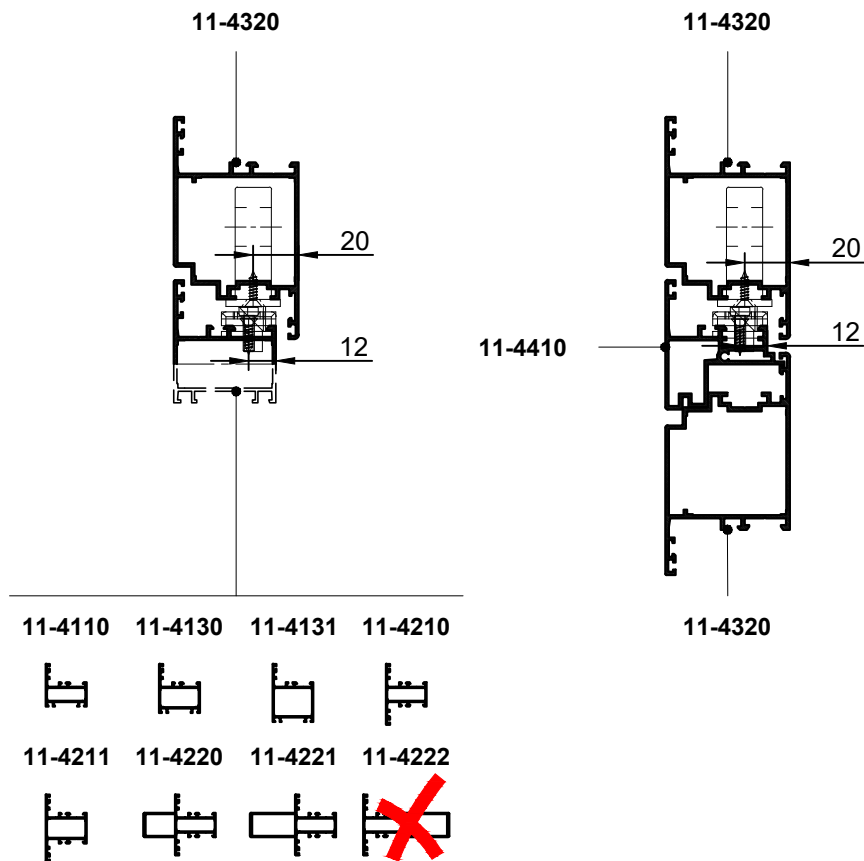

Замок				Планка ответная			Ручка
Внешний вид	Артикул	Наименование	Крепление	Внешний вид	Артикул	Крепление	
	34-22/3506068	Замок МЗК KFV AS2750 24x3x2130-2400/35/92	43-DIN7982C A2 3,9x16 TX15 x10		34-03/3093.00 34-22/3478743 доп x2	43-DIN7982C A2 3,9x16 TX15 x6	34-02/1700-04 Гарнитура нажимной 24/92/76-84
					34-03/3093.00 34-22/3478743 доп x2		



11-4110 11-4130 11-4131 11-4210 11-4211 11-4220 11-4221 11-4222

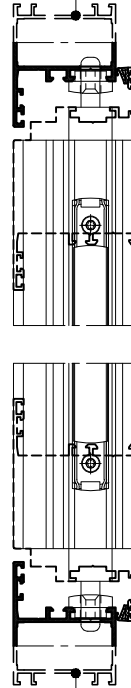
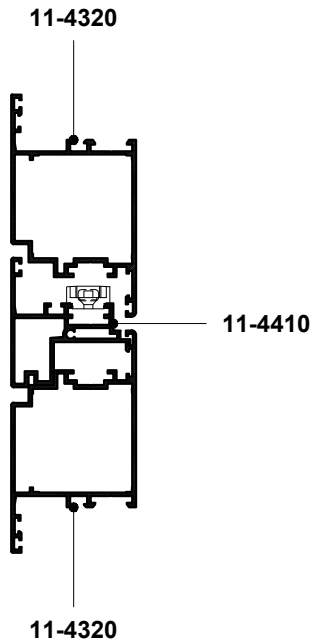
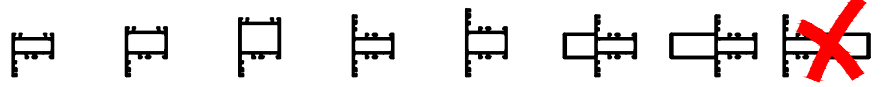

11-4110 11-4130 11-4131 11-4210 11-4211 11-4220 11-4221 11-4222

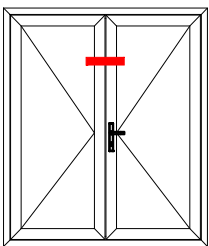
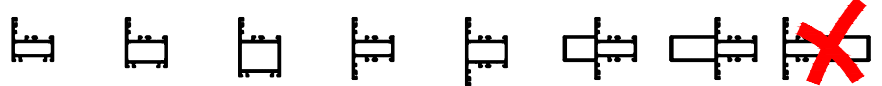

Шпингалет				Планка ответная			Примыкающий элемент
Внешний вид	Артикул	Наименование	Крепление	Внешний вид	Артикул	Крепление	Артикул
	34-19/052401[xx]	Шпингалет 19x8x140	В комплекте		34-19/0524020	В комплекте	11-4110 11-4130 11-4131 11-4210 11-4211 11-4220 11-4221 11-4222

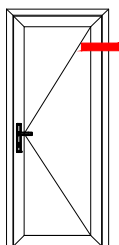
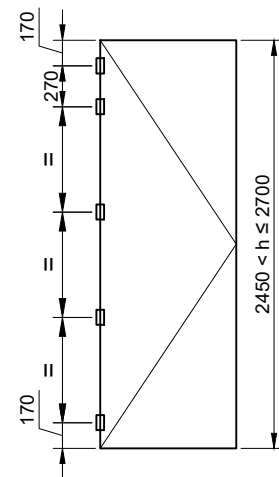
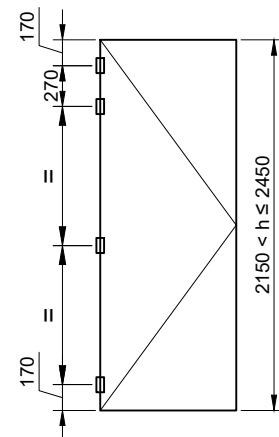
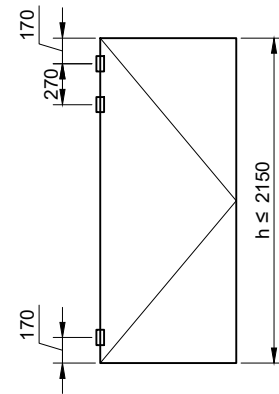
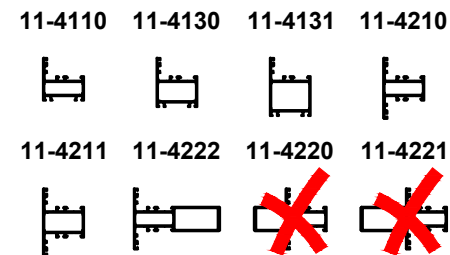
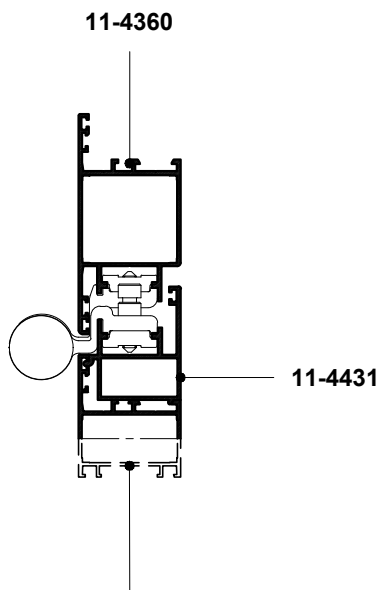
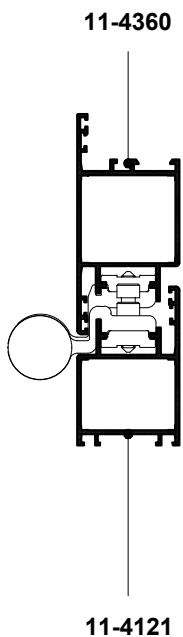

Навес			Крепление
Внешний вид	Артикул	Наименование	
	34-14/00000368	Навес дверной двухчастный ППЕ-2 45	В комплекте
	34-20/SWWWW8010439	Навес двухчастный SWW-W	В комплекте



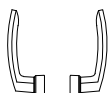
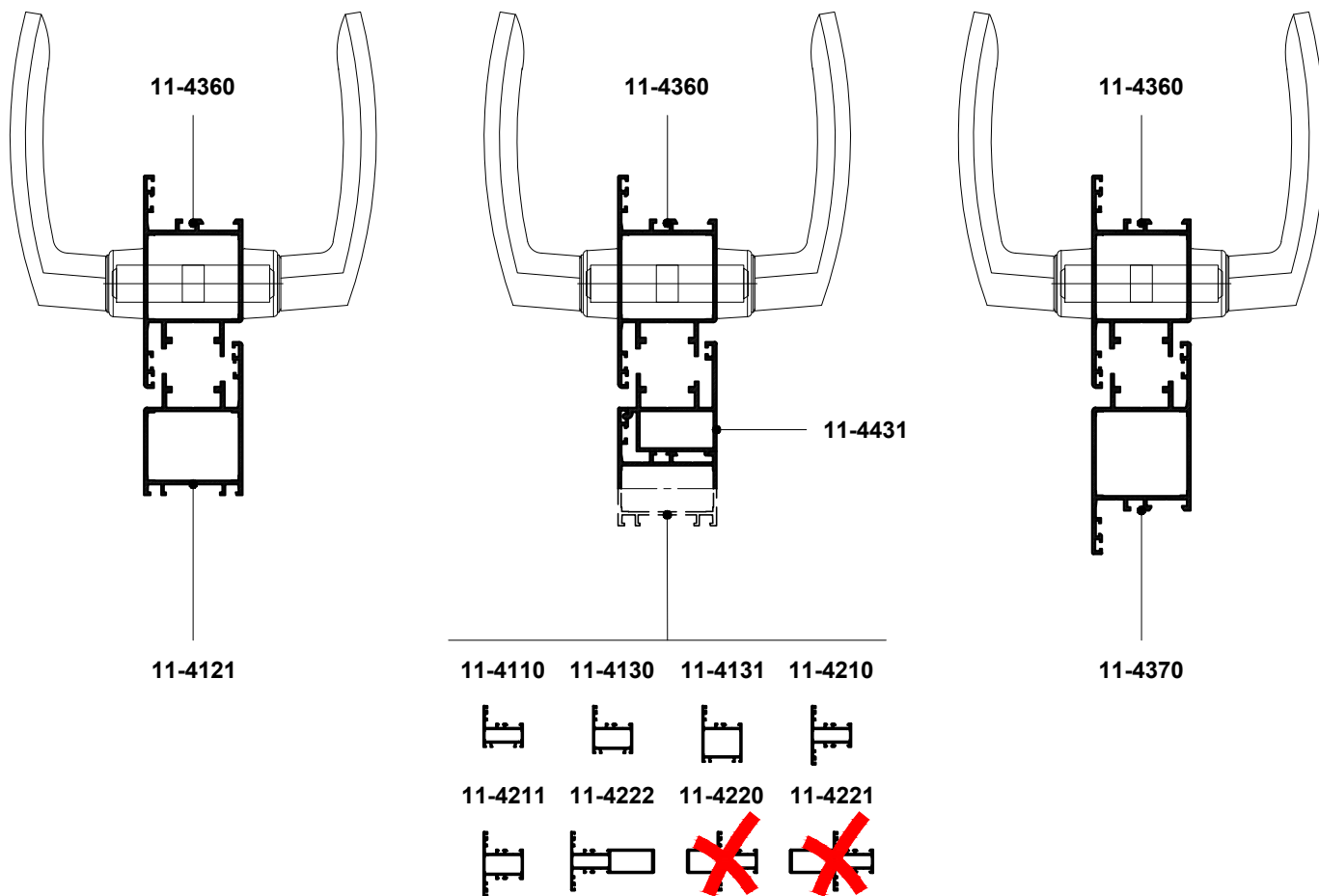

34-19/05182



34-02/1615-03

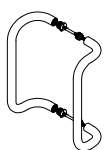

34-02/0206.350

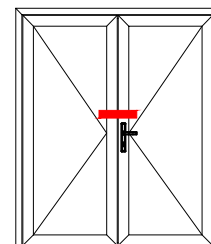
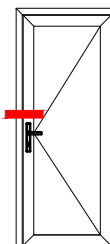

Ручка				Накладка			Цилиндр фигурный
Внешний вид	Артикул	Наименование	Крепление	Внешний вид	Артикул	Крепление	Артикул
	34-19/05182	Комплект ручек нажимных POLARIS	46-DIN965 Zn M5x16 TX25 x8 40-ART1021 A2 M5x11,5 x8		34-19/0508053[xx] x2	41-DIN7981C A2 3,5x6,5 TX10 x4	34-01/0003/3030
	34-02/1615-03	Гарнитура нажимной 32/92/66-75					34-01/0003/3535
	34-02/0206.350	Комплект ручек дверных стационарных			34-19/0508053[xx] x2	41-DIN7981C A2 3,5x6,5 TX10 x4	34-01/0003/3030



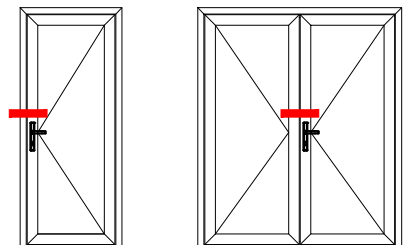
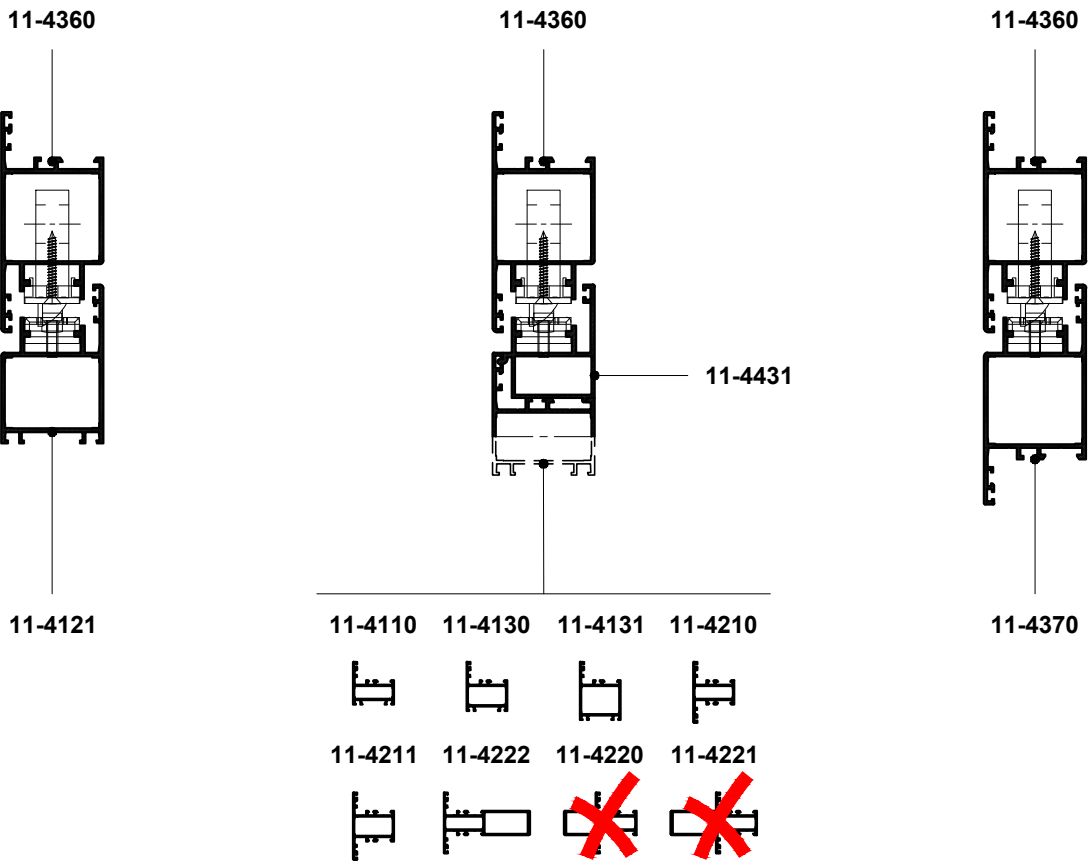

Ручка	Замок				Планка ответная		
	Внешний вид	Артикул	Наименование	Крепление	Внешний вид	Артикул	Крепление
Нажимные 34-19/05182 Комплект ручек нажимных POLARIS 34-02/1615-03 Гарнитур нажимной 32/92/66-75		34-04/110000009810	Замок клиновыи 24x3/92/35 Подкладка 5 мм	43-DIN7982C A2 3,9x32 TX15 x2 34-04/110000009939		34-03/3016.45	В комплекте
		34-22/3469528	Замок клиновыи KFV RES 49N 24x6/92/35	43-DIN7982C A2 3,9x16 TX15 x2		34-22/3477532 L 34-22/3477533 R	34-18/239298 43-DIN7982C A2 3,9x16 TX15 x3
Стационарные 34-02/0206.350 Комплект ручек дверных стационарных		34-22/3469528	Замок клиновыи KFV RES 49N 24x6/92/35	43-DIN7982C A2 3,9x16 TX15 x2		34-22/3477532 L 34-22/3493198	34-18/239298 43-DIN7982C A2 3,9x16 TX15 x3
		34-04/110000009820	Замок роликовыи 24x3/92/35	34-04/110000009939 43-DIN7982C A2 3,9x16 TX15 x2	-	34-22/3477533 R 34-22/3493198	В комплекте 34-18/239298 43-DIN7982C A2 3,9x16 TX15 x3



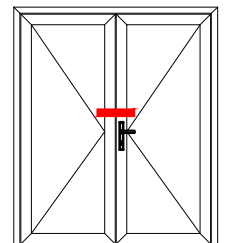
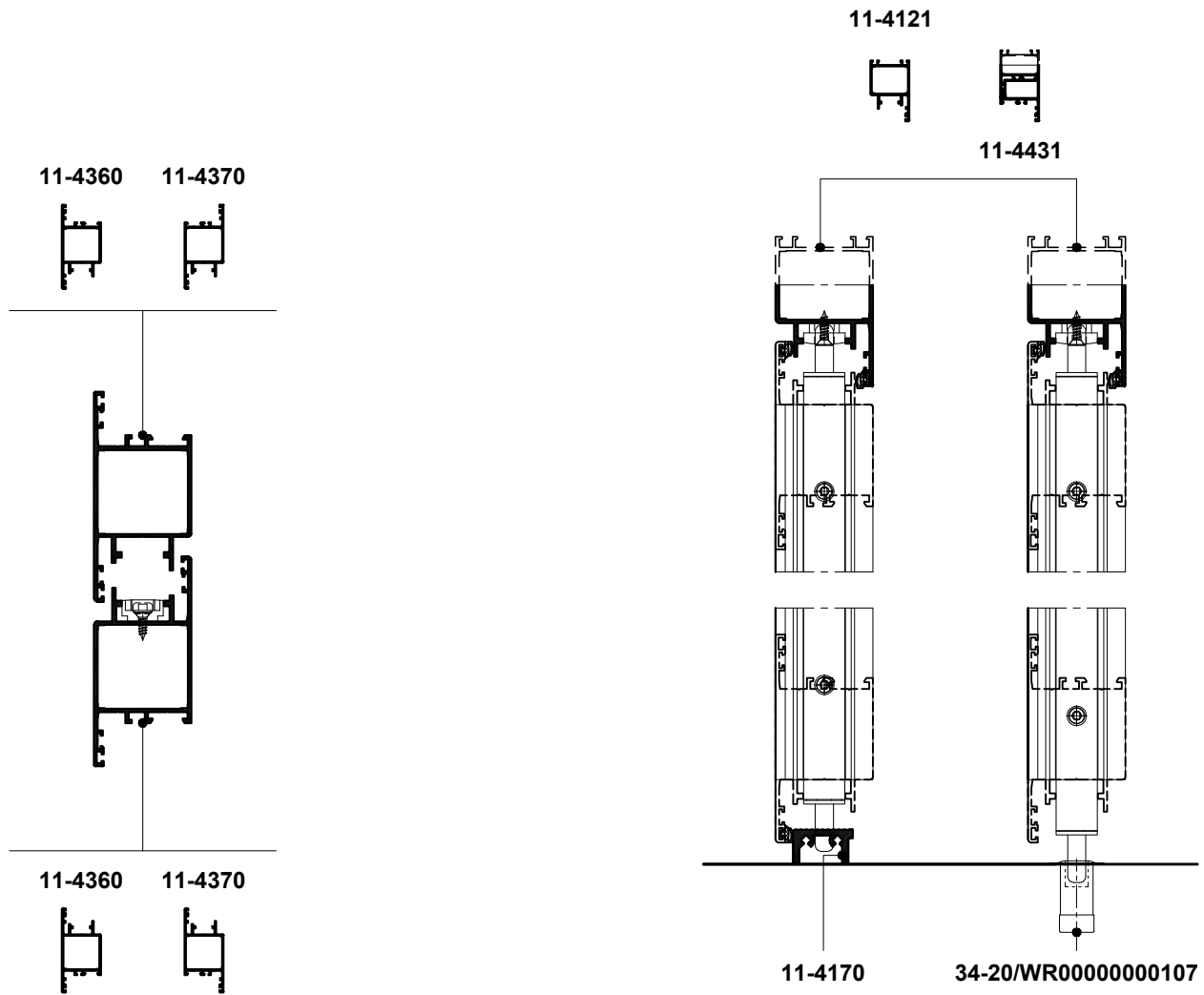

Шпингалет				Планка ответная			Примыкающий элемент
Внешний вид	Артикул	Наименование	Крепление	Внешний вид	Артикул	Крепление	Артикул
	34-19/052402[xx]	Шпингалет 19x8x220	43-DIN7982C A2 3,9x13 TX15 x2		34-19/0524020		11-2140
					34-20/WR00000000107	-	Пол

